

LODES

2021 Collection Catalogue

Pag.	Product name
134	A A-Tube
108	A-Tube Nano
124	A-Tube Nano Duo
268	Aile
336	B Beetle
158	Blow
098	Bugia
146	C Cima
018	E Easy Peasy
346	F Frozen
208	J Jefferson
220	JIM
248	K Kelly
238	Kelly Cluster
264	L Laser
340	M Make-Up
042	N Nautilus
042	Nautilus Mini
192	Nostalgia
090	P Pin-Up
294	Puzzle
278	Puzzle Mega
316	Puzzle Outdoor
306	Puzzle Round
294	Puzzle Twist
062	R Rain
178	Random
162	Random Solo
030	S Sky-Fall
076	Spider
324	V Valentina

Lighting Makers from *Venice* since 1950

Previously known as Studio Italia Design, Lodes completed a rebrand process in June 2020 — on the occasion of its 70th anniversary — which culminated with the unveiling of the new logo and brand identity. Since then, as part of a strategic vision led by General Manager Massimiliano Tosetto, Lodes has been heralding a new era of contemporary design celebrating the company's manufacturing know-how and high-quality *Made in Italy* essence.



Headquarters Marcon, Venice



Warehouse Marcon, Venice

Già conosciuta come Studio Italia Design, Lodes ha completato un processo di rebranding in Giugno 2020 — in occasione del suo settantesimo anniversario — che è culminato con la presentazione del nuovo logo. Da allora, nell'ambito di una visione strategica guidata dal Direttore Generale Massimiliano Tosetto, Lodes ha intrapreso una nuova fase di design contemporaneo che celebra il know-how produttivo insieme all'essenza e alla qualità *Made in Italy* dell'azienda.

Values

Mastery is the know-how consolidated through direct experience and over the years, which gives life to meaningful lighting solutions.

Il *Mestiere* è il saper fare consolidato attraverso l'esperienza diretta e nel corso degli anni, che dà vita a soluzioni illuminotecniche ricche di significato.

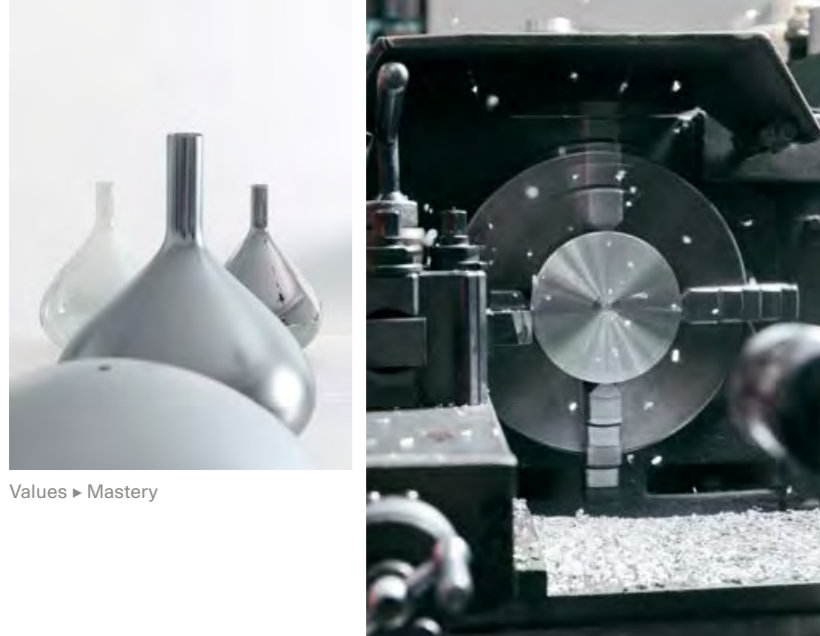

Values ▶ Mastery



Values ▶ Research

Our company history is a family journey of continuous evolution and fast learning. This we call *Research*, our keen curiosity to learn new ways and to constantly renew ourselves.

La nostra storia aziendale è un percorso familiare di evoluzione continua e di apprendimento veloce. È un percorso di *Ricerca*, con la curiosità di apprendere modi nuovi e di rinnovarci costantemente.

Everything we do as is about *Relations*. The relationship with our teams and our partners. The intimate bond between our products and the people who select them. The interaction between lamps and the places they decorate with light.

We are *Italian*, deeply connected to our territory and cultural roots.

Tutto ciò che facciamo riguarda le *Relazioni*. Il rapporto con i nostri team e i nostri partner. L'intimo legame tra i nostri prodotti e le persone che li selezionano. L'interazione tra le lampade e gli ambienti che queste arredano con la luce.

Siamo *Italiani*, profondamente legati al nostro territorio e alle nostre radici culturali.



Values ▶ Relations



Values ▶ Italian

Balancing technical know-how and the best *Made in Italy* design, Venice-based Lodes has been designing and producing lighting solutions for interiors and exteriors since 1950.

Originating in founder Angelo Tosetto's passion for glass and informed by continuous technological research, the company has evolved into one of Europe's leading designers and manufacturers of decorative lighting, currently present in 90 markets worldwide.

Today, Lodes represents a three-generation evolution from pure passion to brilliant architectural solutions, creating light sources that fuse contemporary design and innovative technology with materials of the highest quality, scrupulously developed with the best processing techniques. The firm Studio Italia Design has been selected as one of the most dynamic Italian companies according to the survey "Campioni della crescita 2020" (2020 Growth Champions), as well as in 2021, published in *La Repubblica's* "Affari & Finanza".



Warehouse Marcon, Venice

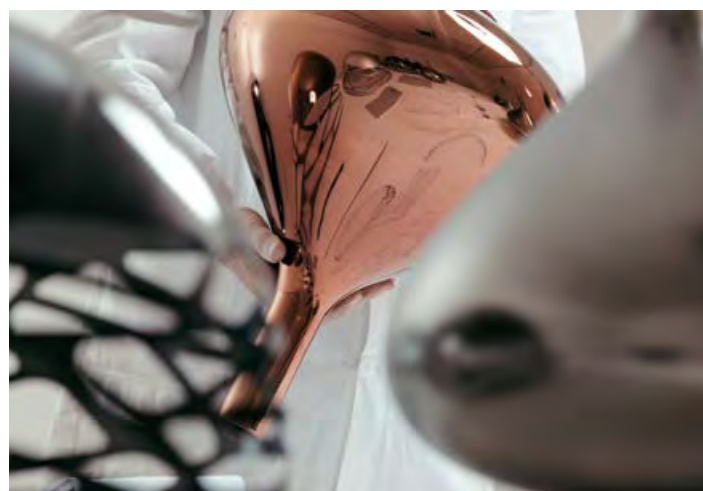

Workshop Marcon, Venice



Massimiliano and Andrea Tosetto

Coniugando il know-how tecnico con il miglior design *Made in Italy*, l'azienda veneziana Lodes progetta e produce soluzioni illuminotecniche d'arredo d'interni ed esterni dal 1950.

Nata dalla passione per il vetro del fondatore Angelo Tosetto, e guidata dalla costante ricerca tecnologica, l'azienda si è trasformata in uno dei principali designer e produttori europei di illuminazione decorativa, attualmente attiva in 90 mercati nel mondo.

Oggi Lodes rappresenta un percorso evolutivo, attraverso tre generazioni, dalla pura passione alle più sorprendenti soluzioni architettoniche, grazie a sorgenti luminose in cui design contemporaneo e tecnologia di punta si integrano con materiali di altissima qualità, sapientemente sviluppati con le migliori tecniche di lavorazione. Studio Italia Design è stata selezionata come una delle aziende italiane più dinamiche secondo l'indagine "Campioni della crescita 2020", così come nel 2021, pubblicata su "Affari & Finanza" di Repubblica.

Innovation and continued research drive Lodes' creative process and product development. Our internal workshop allows us to go from idea to prototype in a matter of hours, and to conceive the most relevant lighting solution.

We offer *mains voltage and low voltage* driverless LED modules – efficient solutions to effectively provide the same light quality as halogen bulbs – which we design and manufacture.

Colour Rendering Index (CRI) is the value that measures the ability of a light source to reproduce the colours of an object. All our LED light sources offer CRI 90 or higher, reflecting the natural colour of objects.

Light colour temperature is expressed in Kelvin degrees and corresponds to the hue emitted by the light source. At 2700 K or 3000 K, our LED modules deliver *warm and emotional light*. All our LED sources provide the same *quality of light colour*.

Colour variations are within the 3rd step of the MacAdam ellipse and are imperceptible to the human eye, which means that different lamps can be combined harmoniously in the same environment.

The *efficiency* of a light source is calculated by dividing the number of lumens by the number of watts (lm / W). The efficiency of our LED modules translates in energy saving.

The *long lifespan* of our LED light sources (> 80,000 hours guaranteed) saves maintenance and replacement costs compared to light bulbs. And, unlike conventional bulbs, LEDs rarely have malfunctions.

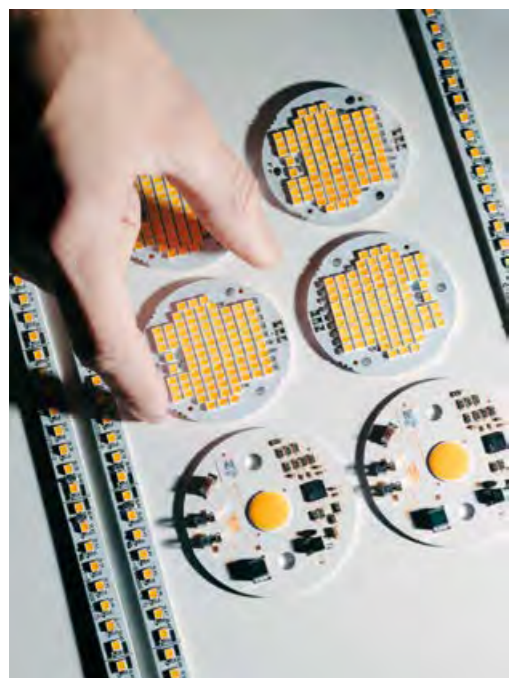

L'innovazione e la ricerca continua guidano il processo creativo e lo sviluppo dei prodotti di Lodes. L'officina interna all'azienda permette di passare velocemente dall'idea al prototipo, per concepire la soluzione di illuminazione più pertinente.

Offriamo moduli LED senza driver *a tensione di rete e a bassa tensione*, soluzioni efficienti che progettiamo e produciamo per fornire efficacemente la stessa qualità di luce delle lampadine alogene.

Il *Colour Rendering Index* (CRI) è il valore che misura la capacità di una sorgente luminosa di riprodurre i colori di un oggetto. Tutte le nostre sorgenti luminose a LED offrono CRI uguale o superiore a 90, che restituisce il colore naturale degli oggetti.

La *temperatura del colore della luce* è espressa in gradi Kelvin e corrisponde alla tonalità emessa dalla sorgente luminosa. Con 2700 K o 3000 K, i nostri LED forniscono una *luce calda ed emozionale*. Tutte le nostre sorgenti LED forniscono la stessa *qualità di colore della luce*.

Le variazioni di colore rientrano nel 3°step dell'ellisse di MacAdam e sono impercettibili all'occhio umano, il che significa che lampade diverse possono essere combinate armoniosamente nello stesso ambiente.

L'*efficienza* di una sorgente luminosa si calcola dividendo il numero di lumen per il numero di watt (lm / W). L'efficienza dei nostri moduli LED si traduce in risparmio energetico.

La *lunga durata* delle nostre sorgenti luminose a LED (>80.000 ore garantite) consente di risparmiare sui costi di manutenzione e di sostituzione rispetto alle lampadine. E, a differenza delle lampadine convenzionali, i LED raramente presentano malfunzionamenti.

Designers

Andrea Tosetto	248	Kelly
	238	Kelly Cluster
	042	Nautilus
	042	Nautilus Mini
	090	Pin-Up
	062	Rain
	324	Valentina
Chia-Ying Lee	178	Random
	162	Random Solo
Dima Loginoff	192	Nostalgia
Luca Nichetto	268	Aile
	018	Easy Peasy
	208	Jefferson
Marco Dessì	146	Cima
Patrick Norguet	220	JIM
Pio & Tito Toso	158	Blow
Studio Italia Design	134	A-Tube
	108	A-Tube Nano
	124	A-Tube Nano Duo
	336	Beetle
	098	Bugia
	346	Frozen
	264	Laser
	340	Make-Up
	294	Puzzle
	294	Puzzle Twist
	278	Puzzle Mega
	316	Puzzle Outdoor
	306	Puzzle Round
	030	Sky-Fall
	076	Spider

Since the early 2000s our company (then Studio Italia Design) has invited external designers to collaborate with our R&D team. Our workshop is the place where designers' creative ideas are shaped, where elaborate sketches give life to visions that evolve until they reach the form we all desire. The encounter of external design perspectives with our solid manufacturing know-how generates fresh and captivating contemporary product narratives.

Fin dai primi anni 2000 la nostra azienda (allora Studio Italia Design) ha invitato designer esterni a collaborare con il nostro team di ricerca e sviluppo. Il nostro laboratorio è il luogo dove le idee creative dei designer prendono forma, dove elaborati schizzi danno vita a visioni che si evolvono fino a raggiungere la forma desiderata. L'incontro di prospettive progettuali esterne con il nostro solido know-how produttivo genera narrazioni di prodotto contemporanee fresche e accattivanti.

Andrea Tosetto

Andrea Tosetto studied at the Art High School and at the Accademia delle Belle Arti in Venice. At the age of 18, he joined the company founded by his father Angelo in 1950, which he soon took over. Andrea marks the transition of the company from the classical lines of that time to an innovative and more contemporary language. His dynamic entrepreneurial style and lively creative vein come to life in refined products that enhance the craftsmanship method. Andrea succeeded in emphasising the company's know-how, focusing on the internalisation of production processes and on the use of quality materials with a strong bond with the Venetian territory. Kelly, Nautilus, Valentina are just some of Andrea's creations for Lodes.

Andrea Tosetto si forma al Liceo Artistico e all'Accademia delle Belle Arti di Venezia. A 18 anni entra a far parte dell'azienda fondata dal padre Angelo nel 1950, di cui presto prenderà le redini. Andrea segna il passaggio dell'azienda dalle linee classiche dell'epoca ad un linguaggio innovativo e più contemporaneo. Il suo stile imprenditoriale dinamico e la sua vena creativa vivace prendono forma in prodotti curati che esaltano il sistema di lavorazione artigianale. Andrea ha saputo dare protagonismo al saper-fare dell'azienda, mirando all'internalizzazione dei processi di produzione e all'utilizzo di materiali di qualità con un forte legame con il territorio veneziano. Kelly, Nautilus, Valentina sono solo alcune delle creazioni di Andrea per Lodes.

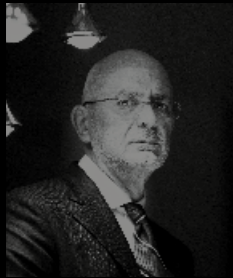

↘ Kelly
↘ Kelly Cluster
↘ Nautilus
↘ Nautilus Mini
↘ Pin-Up
↘ Rain
↘ Valentina

Chia–Ying Lee



Chia–Ying Lee was born in Taiwan and became a designer in new media and industrial design after studying computer science and music. She graduated from the Interaction Design Institute Ivrea in 2006. After working for PEGA Design & Engineering for three years, she set up her studio (studio if) in December 2011. Her work is a blend of design, art and technology embodied in physical forms, from products to installations. She has worked with important institutes such as the National Taiwan Art Museum and the JUT Foundation for Arts and Architecture. Studio if also runs small production of her works for stores and galleries in Europe, Taipei and Beijing. Her projects have won various awards including “IF China Product Design Award”, “Taiwan Excellence Award” and “SDA Best Design of The Year”. She was selected as one of the IFFS Asian Star Talents in 2015. That same year she designed Random for Lodes.

Chia–Ying Lee è nata a Taiwan e, dopo aver studiato informatica e musica, è diventata progettista di design industriale e new media. Laureata all'Interaction Design Institute di Ivrea nel 2006, ha lavorato per tre anni per PEGA Design & Engineering, per poi fondare il suo studio (studio if) nel dicembre 2011. Il suo lavoro è una fusione di design, arte e tecnologia incarnata in forme fisiche, dai prodotti alle installazioni. Ha collaborato con grandi istituti come il National Taiwan Art Museum e la JUT Foundation for Arts and Architecture. Lo studio if realizza anche piccole produzioni delle sue opere per negozi e gallerie in Europa, Taipei e Pechino. I suoi progetti hanno vinto diversi premi tra cui “IF China Product Design Award”, “Taiwan Excellence Award” e “SDA Best Design of The Year”. Nel 2015 è stata selezionata tra i talenti asiatici all'IFFS. Nello stesso anno ha progettato Random per Lodes.

↘ Random
↘ Random Solo

Dima Loginoff

Dima Loginoff was born in 1977 in Moscow, where in 1997 he graduated from the College of Hairdresser's Art and then worked as a designer for over 10 years. In 2008 he graduated wich distinction from the International Design School in Moscow and the Rhodec International Interior Design School in London. Over time he has received important awards including the “Grand Prix Award” in 2007, the “Young Designer of the Year-2010” by Elle Magazine, the “Twelve Golden” by the Russian magazine Interior + Design, several publications in magazines around the world, as well as awards from fashion agencies such as Agenda Inc. (Paris and New York). In 2009, together with other well-known Russian designers, Dima participated in the charity event “The Stars Draw”, the proceeds of which allowed the purchase of tools to promote the creative skills of children in orphanages. Today, in addition to new projects, Dima Loginoff teaches in specialisation courses and holds design seminars. For Lodes she designed the acclaimed Nostalgia suspension lamp.

Dima Loginoff è nato nel 1977 a Mosca, dove nel 1997 si è laureato al College of Hairdresser's Art e poi ha lavorato come stilista per oltre 10 anni. Nel 2008 si è laureato con merito alla International Design School di Mosca e alla Rhodec International Interior Design School di Londra. Nel tempo ha ricevuto importanti riconoscimenti tra cui il “Grand Prix Award” nel 2007, il “Young Designer of the Year-2010” di Elle Magazine, il “Twelve Golden” della rivista russa Interior + Design, diverse pubblicazioni su riviste di tutto il mondo, nonché premi da agenzie di moda come Agenda Inc. (Parigi e New York). Nel 2009, insieme ad altri noti designer russi, Dima ha partecipato all'evento benefico “The Stars Draw”, il cui ricavato ha permesso l'acquisto di strumenti per sviluppare le capacità creative dei bambini negli orfanotrofi. Oggi, accanto a nuovi progetti, Dima Loginoff insegna in corsi di specializzazione e tiene seminari di design. Per Lodes ha progettato l'acclamata sospensione Nostalgia.



↘ Nostalgia

Luca Nichetto

Lodes’ Design Curator, in 2006 Luca Nichetto founded a multidisciplinary design studio in Venice, Italy, which specialised in industrial design, product design and design consulting. From the very beginning, this studio collaborated with a number of different brands and organisations, quickly expanding its influence far beyond Venice and Italy’s borders. Five years later, in 2011, Nichetto opened a second studio in Stockholm, Sweden. This practice was founded in response to an ever-growing number of requests for collaboration from international companies, with the studio’s work also broadening out from its initial focus on designed objects. Nichetto Studio has since expanded into areas such as interior design and architecture. Today, Nichetto Studio works with a variety of brands and clients from all around the world, and its expertise is sought out across all design disciplines.

Design Curator di Lodes, nel 2006 Luca Nichetto ha fondato a Venezia uno studio di design multidisciplinare dedicato a design industriale, progettazione di prodotto e consulenze. Fin dall'inizio lo studio ha avviato collaborazioni con numerosi brand e organizzazioni, espandendo rapidamente il suo raggio d'azione ben oltre i confini di Venezia e dell'Italia. Cinque anni più tardi, nel 2011, Nichetto ha aperto un secondo studio a Stoccolma, Svezia. Questo studio nasce in risposta ad un numero sempre maggiore di richieste di collaborazione da parte di aziende internazionali, ampliando il lavoro dello studio anche al di fuori del suo iniziale focus sulla progettazione di oggetti di design. Nichetto Studio si è ulteriormente ampliato spingendosi in settori affini quali l'interior design e l'architettura. Lo Studio lavora con una varietà di marchi e clienti provenienti da tutto il mondo e la sua esperienza e professionalità sono oggi riconosciute e apprezzate nelle molteplici discipline del mondo del design.



↘ Aile
↘ Easy Peasy
↘ Jefferson

Marco Dessì



Studio Marco Dessì is a multidisciplinary design studio based in Vienna. The studio's approach is practical and collaborative, where design is understood as an interactive process. Self-initiated ventures serve to experiment with materials and test processes that can be later applied onto commercial projects and/or developed further to meet the requirements of industrial or handmade replication. Commissioned design work always starts with immediate study of the client, their respective production methods and methods’ inherent potentials. Dessì's studio is not committed to any particular style, preferred material or unified formula, but rather regards designing as a trade characterised by a deep understanding of materials, processes and how the two are linked. The way in which an object is produced has a direct influence over its aesthetic appearance and the story that it tells. In his work, Marco Dessì values transparency in terms of a consistent link between the process of designing and the actual conditions of production. Established in 2008, the studio works with a list of international clients and cultural institutions on a variety of scales, ranging from furniture and product design to spatial solutions.

Marco Dessì è uno studio di design multidisciplinare con sede a Vienna. Adottando un approccio pratico e collaborativo, lo studio concepisce il design come un processo interattivo. Le iniziative autonome si inseriscono in un'ottica di sperimentazione dei materiali e dei processi finalizzata alla successiva applicazione ai progetti commerciali e / o all'ulteriore sviluppo in funzione dei requisiti di produzione industriale o artigianale. I lavori commissionati non possono prescindere, in primo luogo, da un'analisi accurata del cliente, dei rispettivi metodi produttivi e delle relative potenzialità. Lo studio Dessì non si ispira ad uno stile specifico né predilige un materiale o si basa su una formula universale, bensì si dedica alla progettazione come attività caratterizzata da una profonda comprensione dei materiali, dei processi e del legame tra tali elementi. Il modo in cui un oggetto viene prodotto incide direttamente sulla sua estetica e sulla storia che racconta. Per questo, nei propri lavori Marco Dessì fa della trasparenza il nesso coerente tra il processo di progettazione e le effettive condizioni produttive. Fondato nel 2008, lo studio collabora con clienti internazionali e istituzioni culturali impegnate in settori eterogenei che spaziano dalla progettazione di arredi e prodotti alle soluzioni spaziali.

↘ Cima

Patrick Norguet



Patrick Norguet approaches objects and design from a graphical perspective. Since childhood, he has preferred sketchbooks to textbooks, filling them up with sketches and drawings. A “hands-on” approach of industry and design studies in Paris (ESDI) mark the unusual profile of this constructive rebel. His career underwent a dramatic change in 2000 when Giulio Cappellini spotted his now famous Rainbow Chair. He joined the circle of designers that matter and created his Parisian studio. Since that time, he has been designing for major producers and renowned brands. For Patrick Norguet, design is first and foremost about happy encounters. What he is most passionate about is exchanging with manufacturers, discovering their know-how; the impulse of a creative intention refined by technical constraints, economic stakes and the expectations of a user whom he hopes to discreetly but durably win over. Drawing inspiration from everything that surrounds him, Patrick Norguet does not follow trends but seeks to give shape to products whose relevance and modernity would withstand the test of time: “A well-designed object, an object created through generous collaboration is timeless.” From consumer products to luxury objects, Patrick Norguet leaves an impression of authenticity and elegance. Today, he is an essential figure on the international design scene.

Patrick Norguet si avvicina agli oggetti e al design da una prospettiva grafica. Fin dall'infanzia ha preferito i taccuini da disegno ai libri di testo, riempiendoli di schizzi e bozzetti. Un approccio “pratico” agli studi industriali e di design a Parigi (ESDI) segna il profilo insolito di questo ribelle costruttivo. La sua carriera ha subito una svolta straordinaria nel 2000, quando Giulio Cappellini ha notato la sua ormai famosa Rainbow Chair. Entra a far parte della cerchia dei designer che contano e crea il suo studio parigino. Da allora, progetta per grandi produttori e marche rinomate. Per Patrick Norguet, il design è prima di tutto sinonimo di incontri felici. Ciò che più lo appassiona è lo scambio con i produttori, la scoperta del loro know-how; l'impulso di un'intenzione creativa affinata da vincoli tecnici, da aspetti economici e dalle aspettative dell'utilizzatore che spera di conquistare in modo discreto ma duraturo. Traendo ispirazione da tutto ciò che lo circonda, Patrick Norguet non segue le tendenze, ma cerca di dare forma a prodotti la cui attualità e modernità possano resistere alla prova del tempo: “Un oggetto ben progettato, un oggetto creato grazie a una collaborazione generosa è senza tempo”. Dai prodotti di consumo agli oggetti di lusso, Patrick Norguet lascia un'impressione di autenticità ed eleganza. È oggi una figura essenziale nel panorama del design internazionale.

↘ JIM

Pio & Tito Toso

Pio and Tito are brothers, born in 1973 and 1971 in Venice, where they graduated in Architecture in 1998. In 1996 they founded their design studio Pio & Tito Toso. The Studio works on architecture projects in Italy and abroad, and takes parts in numerous contests. In the field of industrial design the Toso brothers boast projects with the most qualified lighting and furniture companies. They also plan and design booths, exhibitions, shops, offices and warehouses for several companies, curating image and identity.The list of awards they received includes Design Plus Award 2016, Red Dot Design Award 2015, Red Dot Design Award 2012 Good Design Award 2009, I.Dor selection 2006-2007, Young & design 2005. They have participated in exhibitions in Europe and the United States.

I fratelli Pio e Tiro nascono nel 1973 e nel 1971 a Venezia dove si laureano in architettura nel 1998. Nel 1996 aprono lo studio di progettazione Pio & Tito Toso. Lavorano nel campo dell'architettura realizzando numerosi progetti sul territorio nazionale ed internazionale e partecipano a vari concorsi. Nel campo del design industriale vantano collaborazioni con le aziende più qualificate nell'illuminazione e nell'arredo. Progettano stand, esposizioni, negozi, uffici e magazzini per diverse ditte, curandone l'immagine e la grafica. La lista dei riconoscimenti che hanno ricevuto include Design Plus 2016, Red Dot Design Award 2015, Red Dot Design Award 2012, Good Design Award 2009, selezione I.Dor 2006-2007, Young & design 2005. Hanno partecipato a mostre in Europa e Stati Uniti.



↘ Blow

Studio Italia Design

Very often teamwork generates winning ideas. This has been the experience for Studio Italia Design, a creative workshop that brings together different intuitions and gives shape to the ideas of the company's own people-technical and creative staff, insiders who know the sector deeply. The results of the synergy of craft, curiosity and speed, contaminated by the endless energy of Andrea Tosetto, are firmly established success stories, like the suspension lamp Sky–Fall, or the A–Tube and Puzzle collections.

Dal lavoro di squadra nascono molto spesso idee vincenti. È questa l'esperienza di Studio Italia Design, un laboratorio creativo che accoglie le intuizioni e dà forma alle idee delle persone dell'azienda-tecnici, creativi, conoscitori del settore. I risultati della sinergia di mestiere, curiosità e velocità, contaminati dall'energia inesauribile di Andrea Tosetto, sono storie di successo ormai consolidate, come la lampada a sospensione Sky–Fall e le collezioni A–Tube e Puzzle.



↘ A–Tube
↘ A–Tube Nano
↘ A–Tube Nano Duo
↘ Beetle
↘ Bugia
↘ Frozen
↘ Laser
↘ Make–Up
↘ Puzzle
↘ Puzzle Twist
↘ Puzzle Mega
↘ Puzzle Outdoor
↘ Puzzle Round
↘ Sky–Fall
↘ Spider

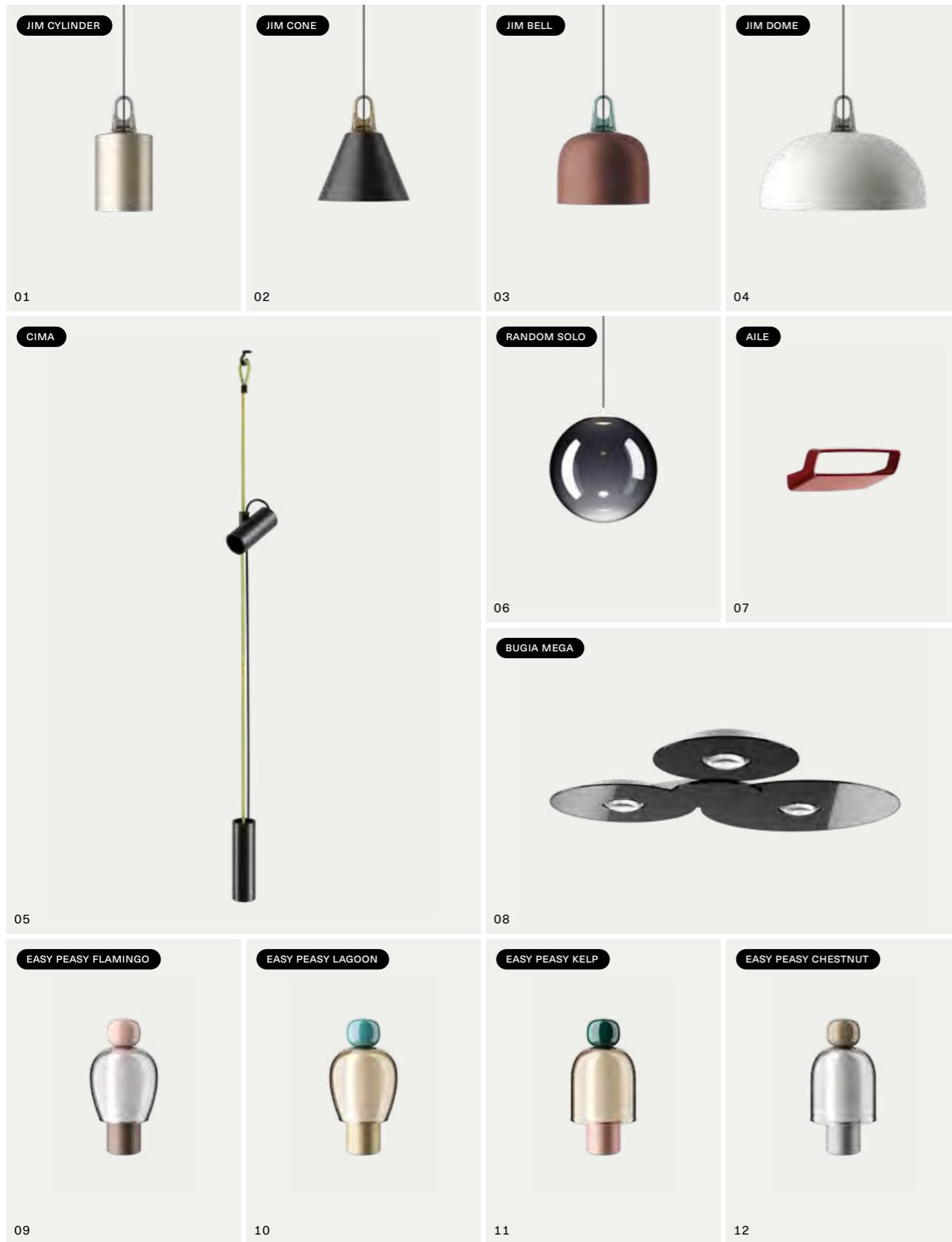

New lamps 2021

01-02-03	JIM cylinder JIM cone JIM bell <i>design by</i> Patrick Norguet	220
	Cluster suspension lamp	
04	JIM dome <i>design by</i> Patrick Norguet	220
	Suspension lamp	
05	Cima <i>design by</i> Marco Dessí	146
	Suspension lamp, Floor lamp	
06	Random Solo <i>design by</i> Chia-Ying Lee	162
	Cluster suspension lamp	
07	Aile <i>design by</i> Luca Nichetto	268
	Wall lamp	
08	Bugia Mega <i>design by</i> Studio Italia Design	098
	Ceiling lamp	
09-10-11-12	Easy Peasy Flamingo Easy Peasy Lagoon Easy Peasy Kelp Easy Peasy Chestnut <i>design by</i> Luca Nichetto	018
	Cordless table lamp	

Cluster suspension lamps

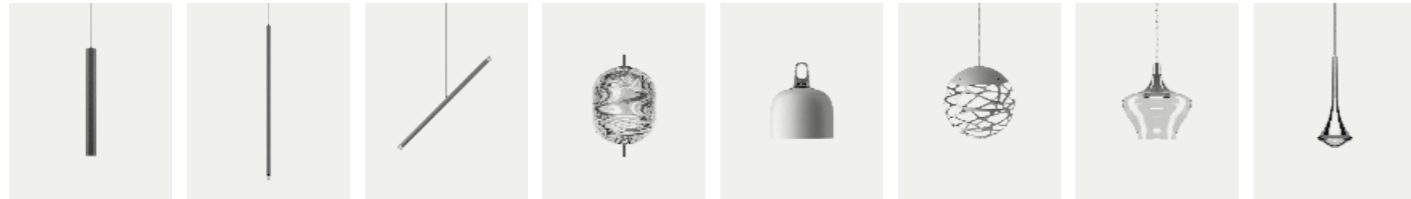

A-Tube Pag. 134
 A-Tube Nano Pag. 108
 A-Tube Nano Duo Pag. 124
 Jefferson Pag. 208
 JIM Pag. 220
 Kelly Cluster Pag. 238
 Nostalgia Pag. 192
 Rain Pag. 062

NEW LAMP



Random Pag. 178
 Random Solo Pag. 162
 Spider Pag. 076
 Valentina Pag. 324

NEW LAMP

Suspension lamps

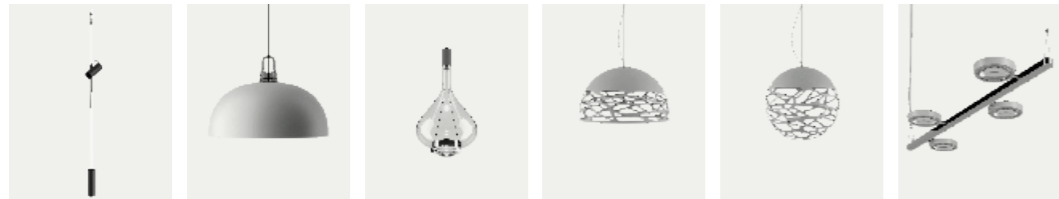

Cima Pag. 146
 JIM Pag. 220
 Sky-Fall Pag. 030
 Kelly dome Pag. 248
 Kelly sphere Pag. 248
 Nautilus Pag. 042

NEW LAMP

NEW LAMP

Wall lamps

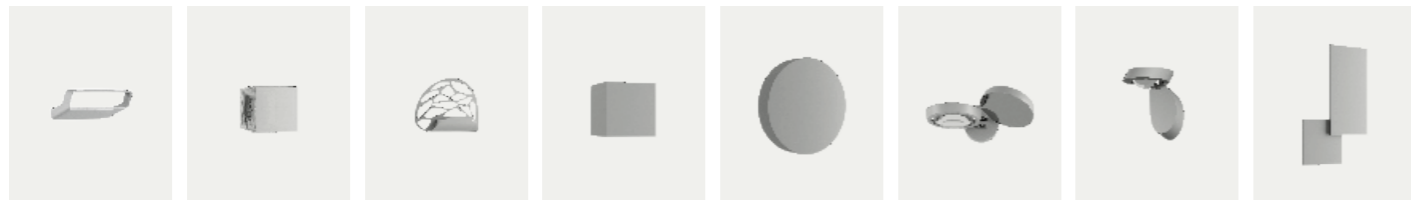

Aile Pag. 268
 Beetle Pag. 336
 Kelly Pag. 248
 Laser Pag. 264
 Make-Up Pag. 340
 Nautilus Pag. 042
 Pin-Up Pag. 090
 Puzzle Pag. 294

NEW LAMP

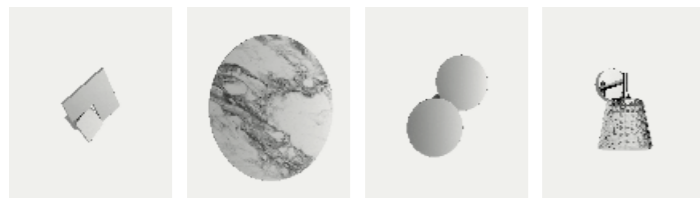

Puzzle Twist Pag. 294
 Puzzle Mega Pag. 278
 Puzzle Round Pag. 306
 Valentina Pag. 324

Ceiling lamps

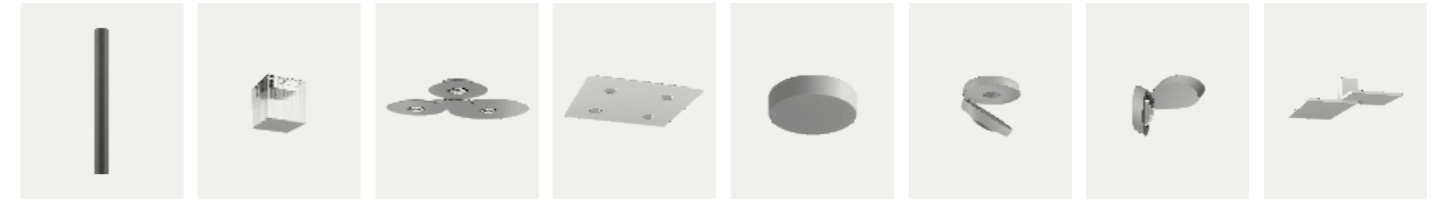

A-Tube Pag. 134
 Beetle Pag. 336
 Bugia Pag. 098
 Frozen Pag. 346
 Make-Up Pag. 340
 Nautilus Pag. 042
 Pin-Up Pag. 090
 Puzzle Pag. 294



Puzzle Twist Pag. 294
 Puzzle Mega Pag. 278
 Puzzle Round Pag. 306

Floor lamp

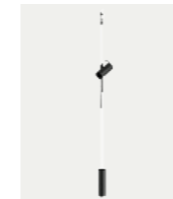

Cima Pag. 146

NEW LAMP

Table lamps

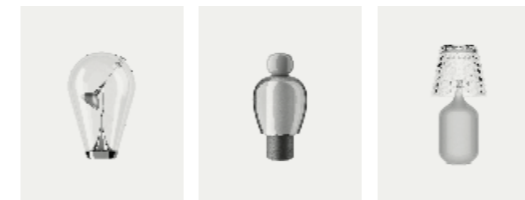

Blow Pag. 158
 Easy Peasy Pag. 018
 Valentina Pag. 324

NEW LAMP

Outdoor lamp



Puzzle Outdoor Pag. 316

Cluster suspension lamps

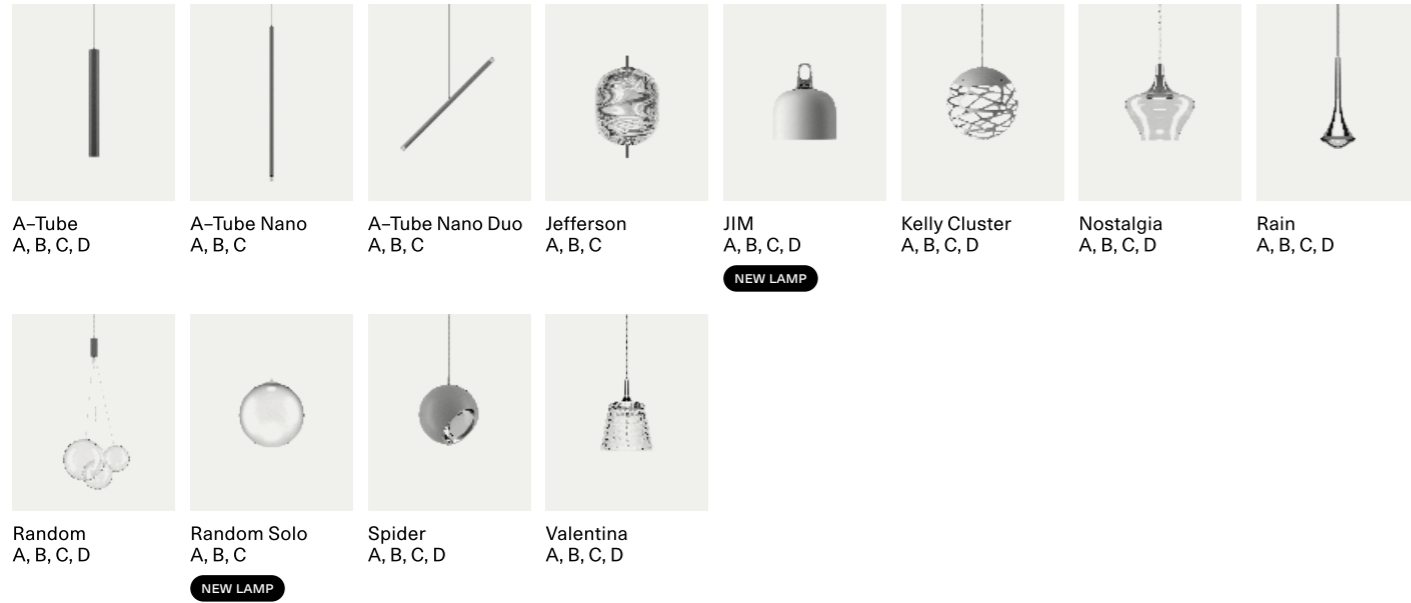

Our canopies are smart functional solutions as well as stand-out decorative elements for suspension lamps or wall fixtures. The variety of our canopy range provides an array of possibilities to personalise any living spaces, whether domestic or public.

I nostri rosoni sono soluzioni funzionali e insieme elementi decorativi differenzianti per lampade a sospensione o a parete. La varietà della nostra gamma di rosoni offre una miriade di possibilità di personalizzazione degli spazi abitativi, domestici e pubblici.

Cluster Systems

Canopies Rosoni	Typology Tipologia	Variants Varianti	Pag.
	A Single Canopies	A. 1 Single Mini A. 2 Recessed Micro A. 3 Wall Standard A. 4 Single Standard	356 356 356 356
	B Track Systems	B. 1 Short B. 2 Long	357 358
	C Cluster Systems	C. 1 3 Lights Round C. 2 5 Lights Round C. 3 7 Lights Round C. 4 14 Lights Round C. 5 24 Lights Round C. 6 36 Lights Round C. 7 7 Lights Rectangular C. 8 14 Lights Rectangular C. 9 28 Lights Rectangular	359 359 359 359 360 360 361 361 361
	D Radial Systems	D. 1 Single or Double Radial Canopy D. 2 4 Lights Radial D. 3 12 Lights Radial D. 4 28 Lights Radial	362 363 363 363

Easy Peasy

With a strong personality and a sculptural form reminiscing the shape of bells, *Easy Peasy* is a set of portable and rechargeable table lamps, consisting of two rounded elements, a body and a knob. Made of blown glass, *Easy Peasy* allows for personal customisation of the living spaces. Its portability, different shapes and colours, and the *dim-to-warm* functionality of its light source allow users to connect, play and interact with the variable configuration options. It is not just a table lamp: it is a real character to interact with!

Con una spiccata personalità e una linea sculturale che ricorda la forma delle campane, *Easy Peasy* è un set di lampade da tavolo portatili e ricaricabili, composte da due elementi stoncati, un corpo e un pomolo. Realizzata in vetro soffiato, *Easy Peasy* permette la personalizzazione individuale degli spazi abitativi. La sua portabilità, le diverse forme e colori e la funzione *dim-to-warm* della sorgente luminosa a LED permettono agli utenti di interagire, giocare e dialogare con le differenti possibilità di configurazione della luce. Non è solo una lampada da tavolo: è un vero e proprio personaggio con cui interagire!

Cordless table lamp

Easy Peasy family,
Lagoon, Flamingo, Kelp and Chestnut

Easy Peasy, design by Luca Nichetto, 2020





Easy Peasy, knob, glass bell, diffuser

Easy Peasy,
Chestnut and Kelp



Easy Peasy, turn on and off, dim light intensity and warmth



Easy Peasy, Chestnut and Flamingo



024

Lodes

Easy Peasy,
Flamingo and Lagoon

025

Easy Peasy

Cordless table lamp



Easy Peasy, packaging



Easy Peasy, micro USB socket

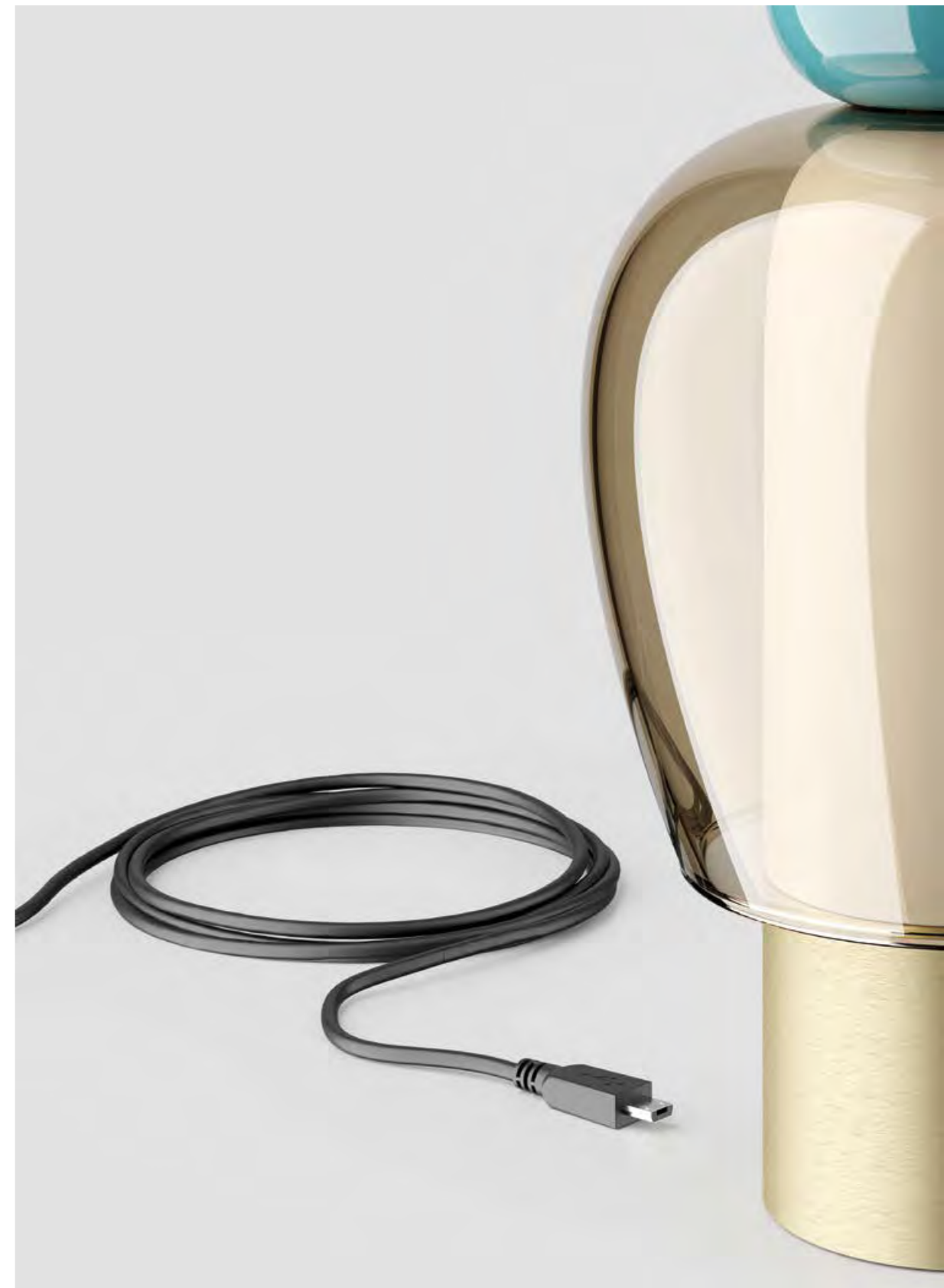

Easy Peasy, portable and rechargeable table lamp

Avec sa forte personnalité et une ligne sculpturale qui rappelle la forme des cloches, *Easy Peasy* est un ensemble de lampes sur table portables et rechargeables, composé de deux éléments arrondis, un corps et un pommeau. Réalisée en verre soufflé, *Easy Peasy* permet la personnalisation individuelle des espaces de vie. Sa portabilité, ses différentes formes et couleurs et la fonction « *dim-to-warm* » de la source lumineuse à LED permettent aux utilisateurs d'interagir, de jouer et de dialoguer avec les différentes possibilités de configuration de la lumière. Ce n'est pas seulement une lampe de table : c'est un véritable personnage avec lequel on peut interagir ! ● FR

Mit einer besonderen Persönlichkeit und einer skulpturalen Linie, die an die Form einer Glocke erinnert, ist *Easy Peasy* ein Set aus mitnehmbaren und aufladbaren Tischleuchten, bestehend aus zwei abgerundeten Elementen, einem Korpus und einem Knauf. Aus geblasenem Glas hergestellt, ermöglicht *Easy Peasy* eine individuelle Personalisierung der Wohnräume. Die Mitnehmbarkeit, die verschiedenen Formen und Farben sowie die Funktion *Dim-to-warm* der LED-Lichtquelle ermöglichen den Nutzern mit den verschiedenen Konfigurationsmöglichkeiten für das Licht zu interagieren, zu spielen und in Dialog zu treten. Es ist nicht nur eine Tischlampe: Es ist eine echte Figur, mit der man interagieren kann. ● DE

Con una marcada personalidad y una línea escultural que recuerda la forma de las campanas, *Easy Peasy* es un set de lámparas de sobremesa portátiles y recargables, compuestas por dos elementos redondeados, un cuerpo y un pomo. Realizada en vidrio soplado, *Easy Peasy* permite la personalización individual de los espacios habitacionales. Su portabilidad, las diversas formas y colores y la función *dim-to-warm* de la fuente luminosa a LED permiten a los usuarios interactuar, jugar y dialogar con las diferentes posibilidades de configuración de la luz. No es sólo una lámpara de mesa: es un personaje real con el que interactuar. ● ES

Обладающие ярко выраженной индивидуальностью и скульптурным силуэтом, напоминающим форму колокола, светильники *Easy Peasy* – это серия портативных перезаряжаемых настольных ламп, состоящих из двух закругленных элементов, корпуса и ручки. Лампы *Easy Peasy*, изготовленные из выдувного стекла, придают оформлению жилого пространства самобытность и оригинальность. Портативность, разнообразие форм и цветов, а также функция *dim-to-warm* источника света LED позволяют пользователям взаимодействовать, фантазировать и применять возможности различных конфигураций освещения. Это не только настольный светильник – это настоящий персонаж с которым можно контактировать. ● RU

*Easy Peasy*具有强烈的个性和雕塑感，酷似铃铛的形状，它是一组便携式可充电台灯，由两个圆形元素组成，一个主体和一个圆头。台灯由吹制玻璃制成，*Easy Peasy*可实现生活空间的个性化定制。它的便携性、不同的形状和颜色及其LED光源*dim-to-warm*的调光功能，允许用户与不同的灯光配置选项进行交互、游戏和对话。*Easy Peasy*不仅是盏台灯：它是一个具有个性能与空间互动的活泼伙伴 ● ZH

Flamingo
↘ Cordless table lamp
NEW LAMP



Lagoon
↘ Cordless table lamp
NEW LAMP

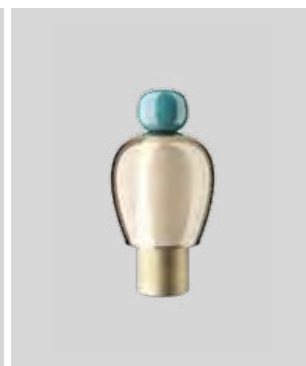

Kelp
↘ Cordless table lamp
NEW LAMP



Chestnut
↘ Cordless table lamp
NEW LAMP



Easy Peasy, design by Luca Nichetto, 2020

Cordless table lamp

Easy Peasy NEW

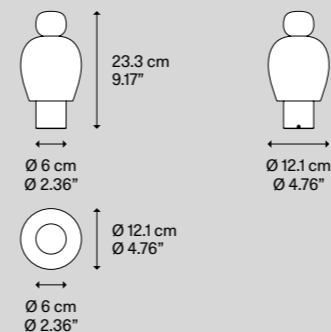

Net weight/Peso netto: 0.85 kg

Pack/Colli: 1

Light source
Sorgente luminosa

Flamingo

LED
↘ Dim-to-Warm
from 2700 K
to 3300 K
↘ 3 W/380 lm
↘ 2000 mA Battery
↘ CRI 90
↘ MacAdam 3-Step

LED and battery included
LED e batteria inclusi

Technopolymer knob
Pomolo in tecnopolimero

Pink NEW
Rosa

Blown glass shade
Cappello in vetro soffiato

Grey NEW
Grigio

Metal base
Base in metallo

Brushed
Bronze
Spazzolato
NEW

170001

Lagoon

LED
↘ Dim-to-Warm
from 2700 K
to 3300 K
↘ 3 W/380 lm
↘ 2000 mA Battery
↘ CRI 90
↘ MacAdam 3-Step

LED and battery included
LED e batteria inclusi

Turquoise NEW
Turchese

Honey NEW
Miele

Brushed
Gold
Oro
Spazzolato
NEW

170002

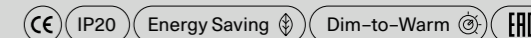

Easy Peasy NEW

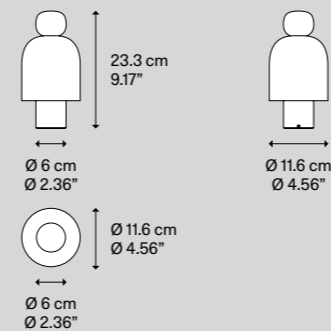

Net weight/Peso netto: 0.85 kg

Pack/Colli: 1

Light source
Sorgente luminosa

Kelp

LED
↘ Dim-to-Warm
from 2700 K
to 3300 K
↘ 3 W/380 lm
↘ 2000 mA Battery
↘ CRI 90
↘ MacAdam 3-Step

LED and battery included
LED e batteria inclusi

Technopolymer knob
Pomolo in tecnopolimero

Green NEW
Verde

Blown glass shade
Cappello in vetro soffiato

Honey NEW
Miele

Metal base
Base in metallo

Brushed
Rose Gold
Oro Rosa
Spazzolato
NEW

170003

Chestnut

LED
↘ Dim-to-Warm
from 2700 K
to 3300 K
↘ 3 W/380 lm
↘ 2000 mA Battery
↘ CRI 90
↘ MacAdam 3-Step

LED and battery included
LED e batteria inclusi

Taupe NEW
Grigio Caldo

Grey NEW
Grigio

Brushed
Palladium
Spazzolato
NEW

170004

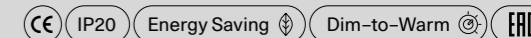

Battery charging time
Tempo di ricarica

Power supply

1A ▶ 180 min

Battery life
Durata batteria

Full power (100%) ▶ 6h
Half power (50%) ▶ 10h
Minimum power (10%) ▶ 19h

Sky-Fall

In Sky-Fall, the traditional glass processing techniques embrace the most advanced LED technologies. The shape of Sky-Fall captures the imagination in its reminiscence of ancient decanters in precious blown glass. Its function amazes thanks to the innovative double LED source that diffuses direct and indirect light. Available in two sizes and in five finishes, Sky-Fall decorates both when it is on and when it is off.

In Sky-Fall le tradizionali tecniche di lavorazione del vetro abbracciano le tecnologie LED più avanzate. La forma di Sky-Fall emoziona ricordando antichi decanter in prezioso vetro soffiato. La sua funzione stupisce grazie all'innovativa doppia sorgente a LED che diffonde luce diretta e indiretta. Disponibile in due dimensioni e in cinque finiture, Sky-Fall arreda sia da accesa che da spenta.

Suspension lamp

Sky-Fall large and medium,
FINISH Glossy Smoke

Sky-Fall, *design by* Studio Italia Design, 2014





Sky-Fall large and medium, FINISH Clear



Sky-Fall, FINISH Clear

Sky-Fall large and medium,
FINISH Glossy Smoke





Sky-Fall medium,
FINISH Chrome



Sky-Fall medium and large, FINISHES Clear and Rose Gold

Sky-Fall medium and large,
FINISH Glossy Bronze





Sky-Fall medium, FINISH Clear

Chez Sky-Fall, les techniques traditionnelles de travail du verre adoptent les technologies LED les plus pointues. La forme de Sky-Fall passionne en rappelant d'anciennes décanteurs en verre soufflé précieux. Son fonctionnement étonne grâce à la double source LED innovante qui diffuse une lumière directe et indirecte. Disponible en deux tailles et cinq finitions, Sky-Fall décore aussi bien allumée qu'éteinte. ● FR

Bei Sky-Fall treffen traditionelle Glasverarbeitungstechniken auf fortschrittlichste LED-Technologien. Die Form von Sky-Fall begeistert und erinnert an alte Dekanter aus hochwertigem, geblasenem Glas. Die Funktion der Lampe beeindruckt dank der innovativen, doppelten LED-Lichtquelle, die gleichzeitig für direkte und indirekte Beleuchtung sorgt. In zwei Größen und mit fünf Oberflächen verfügbar, ist Sky-Fall sowohl ein- wie auch ausgeschaltet ein schöner Einrichtungsgegenstand. ● DE

En Sky-Fall las tradicionales técnicas de elaboración del vidrio abrazan las tecnologías LED más avanzadas. La forma de Sky-Fall emociona recordando antiguos decantadores en precioso vidrio soplado. Su función impacta gracias a la innovadora doble fuente de LED que difunde luz directa e indirecta. Disponible en dos dimensiones y en cinco acabados, Sky-Fall decora tanto encendida como apagada. ● ES

В светильниках Sky-Fall традиционные методы обработки стекла сливаются воедино с самыми передовыми светодиодными технологиями. Форма светильника Sky-Fall, напоминающая старинные декантеры для вина из ценного дутого стекла, пробуждает эмоции. Его функциональность, обеспечиваемая инновационным двойным светодиодным источником с прямым и непрямым распределением света, впечатляет. Светильник Sky-Fall доступен в двух размерах и в пяти вариантах отделки и украшает интерьер как во включенном, так и в выключенном состоянии. ● RU

Sky-Fall 融汇了传统玻璃工艺与最先进的LED技术。Sky-Fall的形状令人联想起以珍贵吹制玻璃制成的古老酒壶。创新的双LED光源，分别发出直接和间接灯光，功能令人惊喜。可提供两种尺寸，五种表面处理，Sky-Fall无论在点亮或熄灭时，都发挥着装饰功能。● ZH

Sky-Fall medium › Suspension lamp

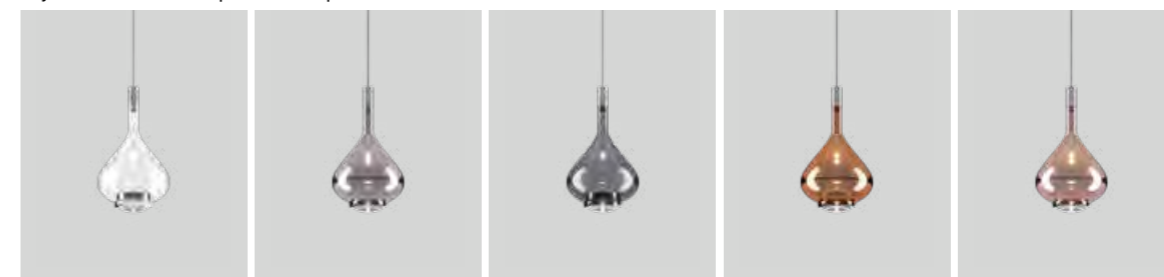

Sky-Fall large › Suspension lamp



Sky-Fall, design by Studio Italia Design, 2014

Suspension lamp

Sky-Fall medium

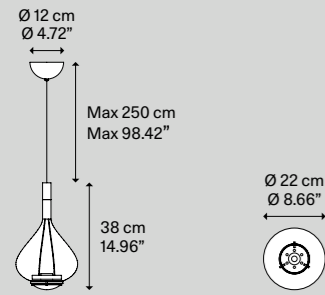

Light source
Sorgente luminosa

LED
 ↘ 2700 K
 ↘ 2 × 10 W/ 1815 lm
 ↘ 350 mA
 ↘ CRI 95
 ↘ MacAdam 3-Step

LED and driver included
 LED e driver inclusi

Metal structure
Montatura in metallo

Chrome Cromo

Blown glass diffuser
Diffusore in vetro soffiato

- Clear Trasparente **148001**
- Glossy Bronze Bronzo Lucido **148002**
- Chrome Cromo **148005**
- Rose Gold Oro Rosa **148008**
- Glossy Smoke Fumo Lucido **148009**

Code
Codice

Net weight/Peso netto: 1.65 kg Pack/Colli: 2

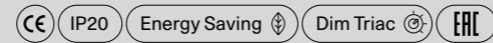

Sky-Fall large

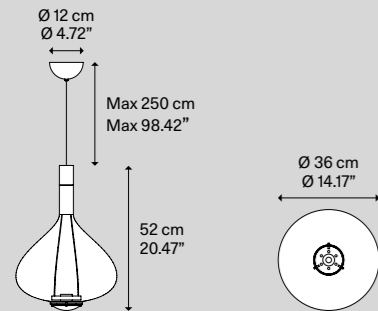

LED
 ↘ 2700 K
 ↘ 2 × 10 W/ 1815 lm
 ↘ 350 mA
 ↘ CRI 95
 ↘ MacAdam 3-Step

LED and driver included
 LED e driver inclusi

Chrome Cromo

- Clear Trasparente **148003**
- Glossy Bronze Bronzo Lucido **148004**
- Chrome Cromo **148006**
- Rose Gold Oro Rosa **148007**
- Glossy Smoke Fumo Lucido **148010**

Code
Codice

Net weight/Peso netto: 3.05 kg Pack/Colli: 2

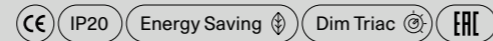

Canopy

Double canopy Sky-Fall NEW

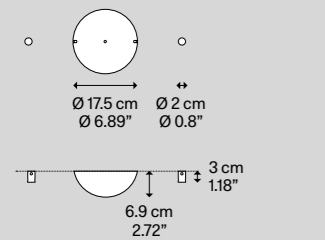

Description
Descrizione

Double canopy mod. Sky-Fall
 Rosone doppio mod. Sky-Fall

System
Sistema

Sky-Fall System

Metal structure
Montatura in metallo

Chrome Cromo

Code
Codice

148100

Net weight/Peso netto: 0.90 kg Pack/Colli: 1



Sky-Fall, design by Studio Italia Design, 2014

Wall Bracket

Sky-Fall wall

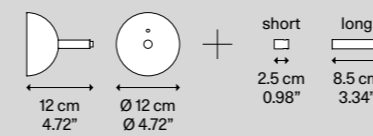

Net weight/Peso netto: 0.4 kg Pack/Colli: 1

Description
Descrizione

Wall bracket mod. Sky-Fall
 Rosone a parete mod. Sky-Fall

System
Sistema

Sky-Fall System

Metal structure
Montatura in metallo

Chrome Cromo

Code
Codice

100039



Track

Sky-Fall Short Track

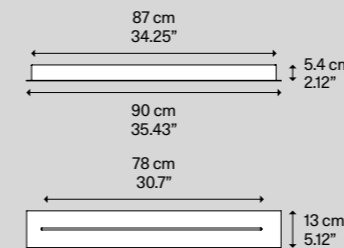

Net weight/Peso netto: 4.6 kg Pack/Colli: 1

Multiple linear track mod. Sky-Fall max 3 suspensions

Sky-Fall System

Matte White - 9010
 Bianco Opaco - 9010

100031

Binario lineare multiplo mod. Sky-Fall max 3 sospensioni



Track

Sky-Fall Long Track

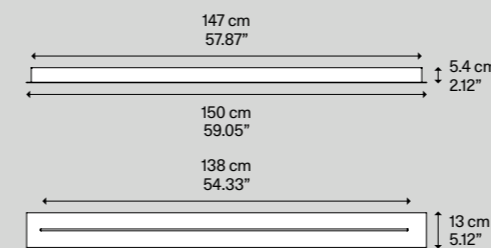

Net weight/Peso netto: 8.2 kg Pack/Colli: 1

Multiple linear track mod. Sky-Fall max 5 suspensions

Sky-Fall System

Matte White - 9010
 Bianco Opaco - 9010

100032

Binario lineare multiplo mod. Sky-Fall max 5 sospensioni



WALL ▶ Both accessories in the two available lengths are supplied in the box with the wall bracket.
 TRACK ▶ Tracks are only for Sky-Fall suspensions. Each suspension should be separated from the canopy and installed on the track. Each suspension should be installed on the track using the driver removed from the original canopy.

WALL ▶ Entrambi gli accessori nelle due diverse lunghezze sono inclusi nella confezione con il supporto a parete.
 TRACK ▶ I binari sono utilizzabili solo con le sospensioni Sky-Fall che dovranno essere separate dai rosoni ed installate sui binari. Per ogni sospensione dovrà essere installato nel binario il rispettivo driver rimosso dal rosone originale.

Nautilus, Nautilus Mini

Strong design and leading-edge technology come together in this family of lamps characterised by a convex lens that projects the LED light wherever its needed or most preferred, for a truly efficient and personalised result. Versatile and dynamic, either on the wall, ceiling or suspended in a variety of versions and finishes, Nautilus lamps satisfy a full range of lighting needs, whether functional or purely decorative, in both residential and professional contexts.

Design deciso e tecnologia di punta si fondono in questa famiglia di lampade caratterizzate da una lente convessa che proietta la luce a LED dove serve o dove piace di più, per un risultato di efficienza e personalizzazione. Versatili e dinamiche, a parete, a soffitto o a sospensione, in diverse versioni e finiture, le lampade Nautilus soddisfano innumerevoli esigenze di illuminazione, dalle più funzionali a quelle particolarmente decorative, sia in ambito residenziale che professionale.

Suspension lamp, Wall lamp, Ceiling lamp

Nautilus and Nautilus Spot,
FINISHES Total Matte Black and Chrome

Nautilus, *design by* Andrea Tosetto, 2017/2020

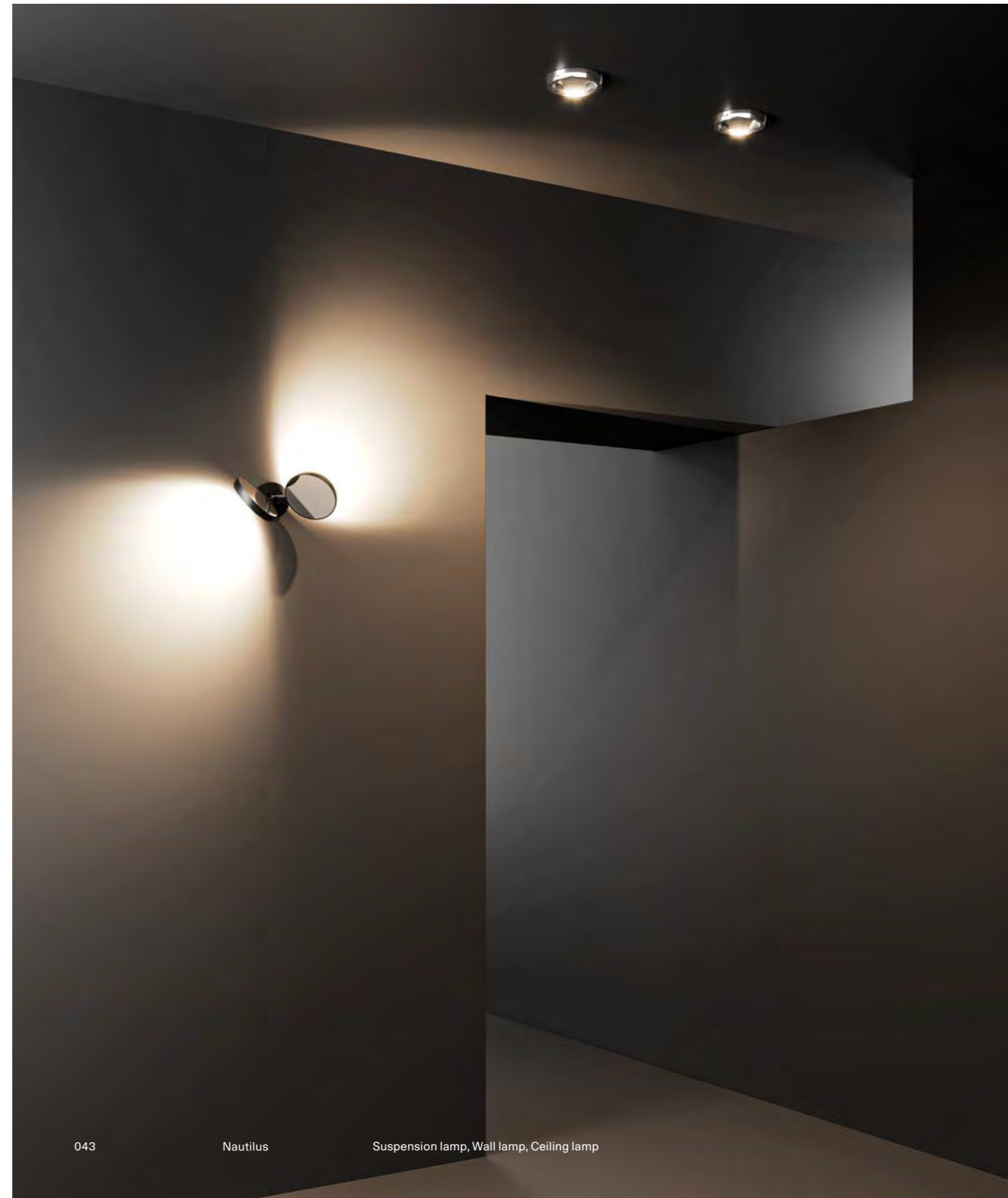



Nautilus,
FINISH Total Matte Champagne

Nautilus Spot,
FINISH Matte Champagne

Nautilus,
FINISH Matte White

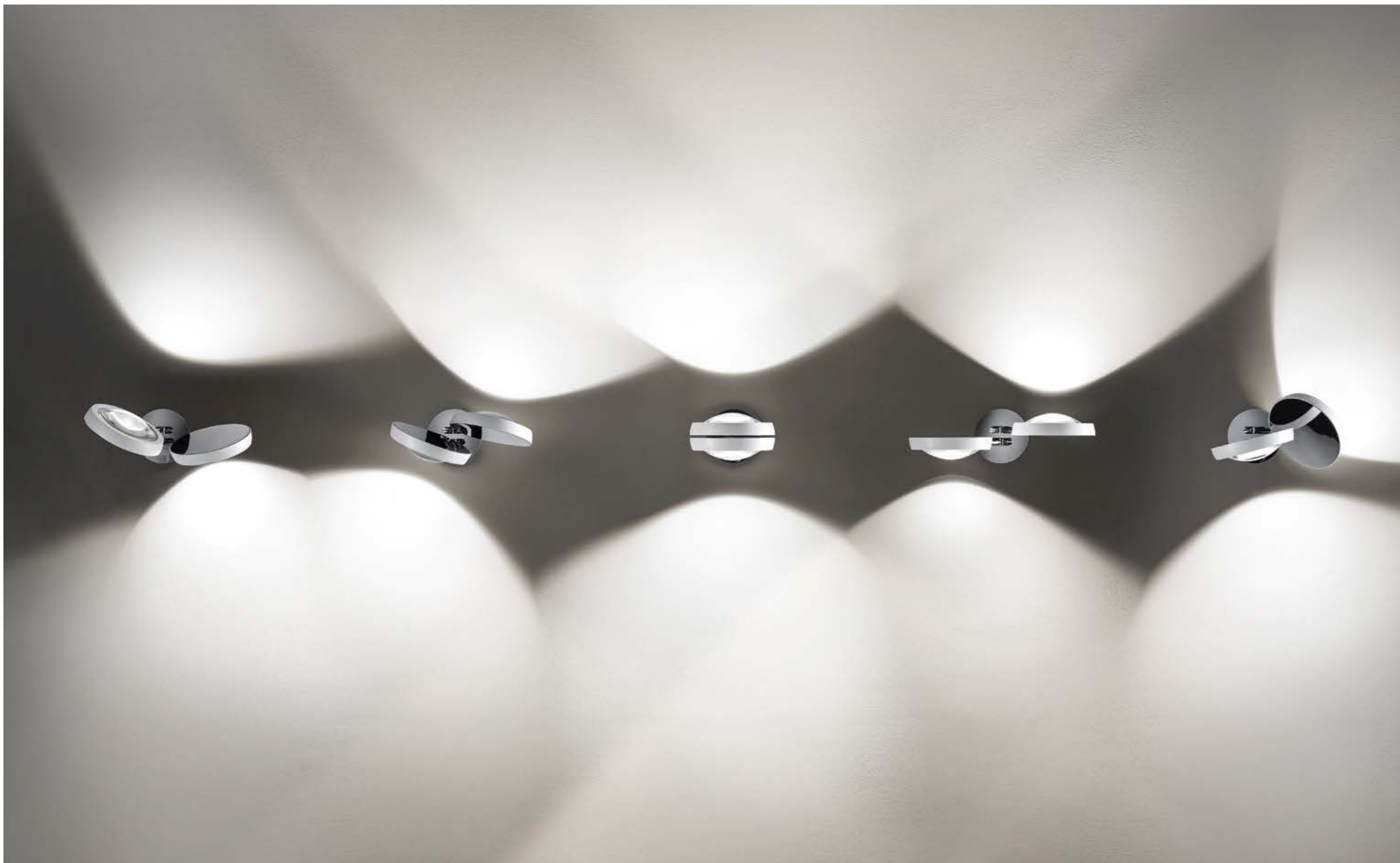

1–Nautilus,
FINISH Total Matte White

2–Nautilus,
FINISH Total Matte Black



Nautilus Spot, FINISHES Matte Champagne, Chrome and Matte Black

Nautilus and Nautilus Spot,
FINISH Matte Black





Nautilus, FINISH Matte White

1, 2



3, 4



1/4–Nautilus,
FINISHES Chrome, Matte Champagne,
Matte Black and Matte White

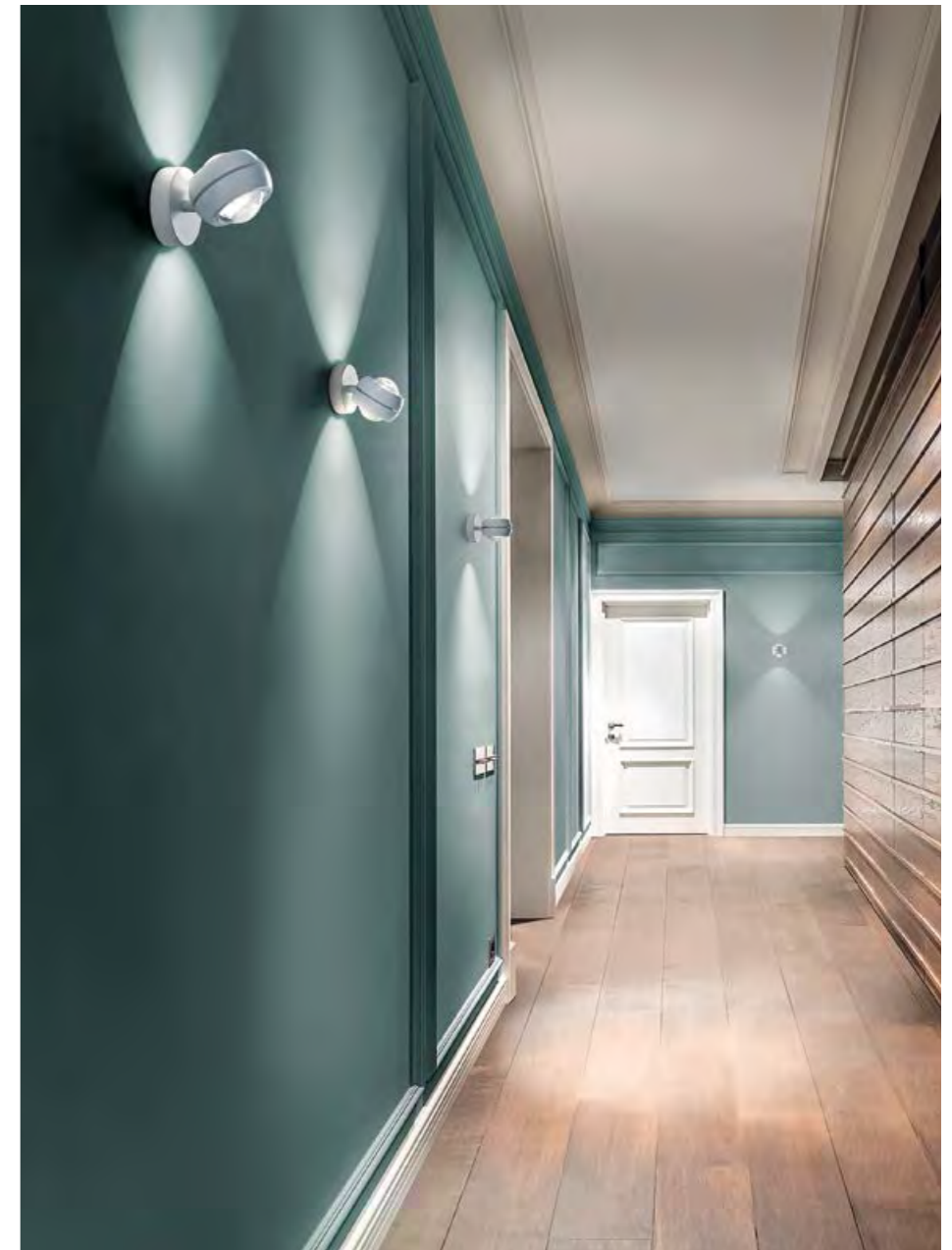

Nautilus Mini, FINISH Matte White

Nautilus Mini,
FINISH Matte Champagne

Nautilus Mini,
FINISH Matte White



1/3–Nautilus Mini,
FINISH Matte Black



Nautilus, FINISH Matte White



Nautilus,
FINISH Chrome

Un design impeccable et une technologie de pointe fusionnent pour cette famille de lampes caractérisées par un verre convexe qui dirige la lumière à LED où il le faut et où vous le souhaitez le plus, pour un résultat efficace et personnalisé. Polyvalentes et dynamiques, appliques, plafonniers ou suspension, en différentes versions et finitions, les lampes Nautilus répondent à d'innombrables besoins d'éclairage, des plus fonctionnels à ceux particulièrement décoratifs, aussi bien dans le domaine résidentiel que professionnel. ●FR

Entschlossenes Design und Spitzentechnologie verschmelzen in dieser Leuchtenfamilie miteinander. Dabei ist letztere durch eine konvexe Linse gekennzeichnet, die LED-Licht dorthin strahlt, wo es notwendig ist oder am besten gefällt. So entsteht ein effizientes, personalisiertes Ergebnis. Vielseitig und dynamisch entsprechen die Wand-, Decken- oder Hängeleuchten Nautilus in verschiedenen Versionen und Ausführungen zahlreichen Bedürfnissen betreffend die Beleuchtung nach - von besonders funktionell bis hin zu besonders dekorativ, sowohl im Wohnbereich wie auch im beruflichen Umfeld. ●DE

El diseño decisivo y la tecnología de vanguardia se unen en esta familia de lámparas caracterizada por una lente convexa que proyecta la luz LED donde se necesita o donde más gusta, para un resultado de eficiencia y personalización. Versátiles y dinámicas, de pared, de techo o colgantes, en diferentes versiones y acabados, las lámparas Nautilus satisfacen innumerables necesidades de iluminación, desde las más funcionales hasta las más decorativas, tanto en entornos residenciales como profesionales. ●ES

Чистый дизайн и передовые технологии сочетаются в этом семействе светильников, характеризующихся выпуклой линзой, которая проецирует свет лампы LED туда, где это необходимо или где вам больше нравится, обеспечивая эффективность и персонализацию. Светильники Nautilus, универсальные и динамичные, настенные, потолочные или подвесные, в разных вариантах исполнения и отделки, удовлетворяют бесчисленные потребности светового оформления, от самого функционального до особо декоративного, как в жилых, так и в офисных помещениях. ●RU

决定性的设计与最先进的技术相结合，凸透镜是该家族系列灯具的特征，该凸透镜可将LED光投射到需要的地方或您最喜欢的地方，以提高效率和定制化。Nautilus灯具有多功能性和动态性，可以壁式安装、吸顶安装或悬吊安装，具有不同的版本和颜色，可以满足无数的照明需求，从最实用的功能到特别装饰性的功能，无论是在住宅还是在专业环境中。●ZH

Nautilus ↘ Wall lamp



Nautilus Mini ↘ Wall lamp

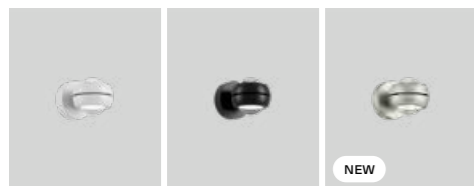

Nautilus ↘ Ceiling lamp

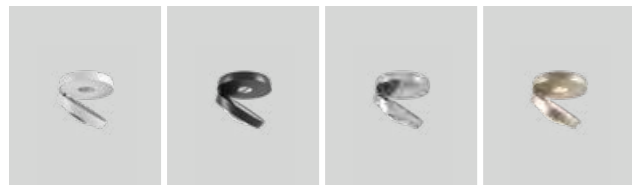

Nautilus Spot ↘ Ceiling lamp

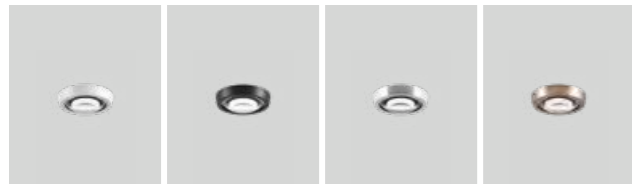

Nautilus ↘ Suspension lamp

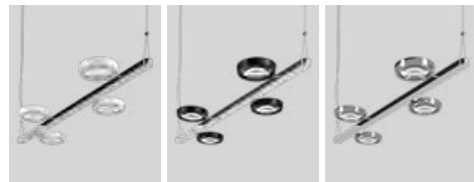

Nautilus, design by Andrea Tosetto, 2017

Wall lamp

Nautilus

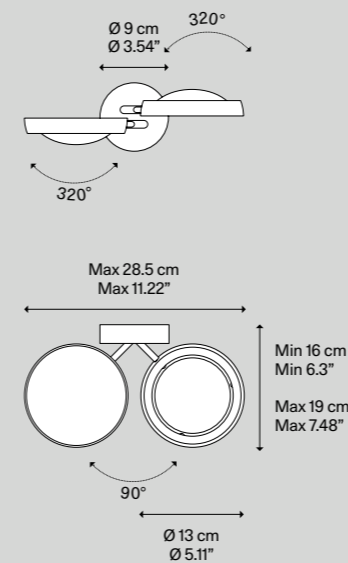

Light source Sorgente luminosa	Metal structure Montatura in metallo	Metal diffuser Diffusore in metallo	Code Codice
LED ↘ 2700 K ↘ 2 × 12 W/2230 lm ↘ 220-240 V ↘ CRI 90 ↘ MacAdam 3-Step	Chrome Cromo	Matte White - 9010 Bianco Opaco - 9010	165101
		Matte Black - 9005 Nero Opaco - 9005	165102
LED included LED incluso	or	Chrome Cromo	165103
		Matte White - 9010 Bianco Opaco - 9010	165148
LED included LED incluso	or	Matte Black - 9005 Nero Opaco - 9005	165149
		Matte Champagne Champagne Opaco	165150
LED ↘ 3000 K ↘ 2 × 12 W/2420 lm ↘ 220-240 V ↘ CRI 90 ↘ MacAdam 3-Step	Chrome Cromo	Matte White - 9010 Bianco Opaco - 9010	165106
		Matte Black - 9005 Nero Opaco - 9005	165107
LED included LED incluso	or	Chrome Cromo	165108
		Matte White - 9010 Bianco Opaco - 9010	165151
LED included LED incluso	or	Matte Black - 9005 Nero Opaco - 9005	165152
		Matte Champagne Champagne Opaco	165153

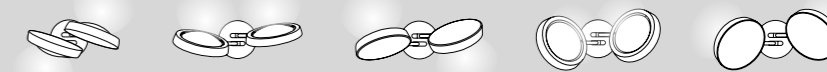

Adjustable light
Luce orientabile

Net weight / Peso netto: 1.15 kg

Pack / Colli: 1

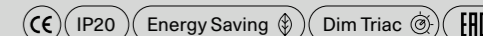

LED sources with direct power supply to the AC line voltage - driver not required. Dimmable with phase cut dimmer.

LED con alimentazione diretta a tensione di rete - non necessita di driver. Dimmerabile con varialuce a taglio di fase.

Nautilus Mini, design by Andrea Tosetto, 2017

Wall lamp

Nautilus Mini

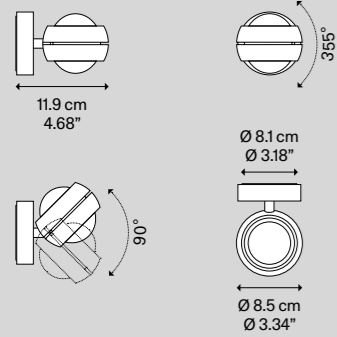

Light source Sorgente luminosa	Metal structure Montatura in metallo	Code Codice
LED ↘ 2700 K ↘ 2 × 6 W / 1120 lm ↘ 220-240 V ↘ CRI 90 ↘ MacAdam 3-Step LED included LED incluso	<ul style="list-style-type: none"> Matte White - 9010 Bianco Opaco - 9010 Matte Black - 9005 Nero Opaco - 9005 Matte Champagne ^{NEW} Champagne Opaco 	165141 165142 165154
or		
LED ↘ 3000 K ↘ 2 × 6 W / 1210 lm ↘ 220-240 V ↘ CRI 90 ↘ MacAdam 3-Step LED included LED incluso	<ul style="list-style-type: none"> Matte White - 9010 Bianco Opaco - 9010 Matte Black - 9005 Nero Opaco - 9005 Matte Champagne ^{NEW} Champagne Opaco 	165146 165147 165155



Adjustable light
Luce orientabile

Net weight / Peso netto: 0.75 kg Pack / Colli: 1

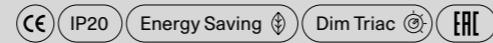

Nautilus, design by Andrea Tosetto, 2017

Ceiling lamp

Nautilus

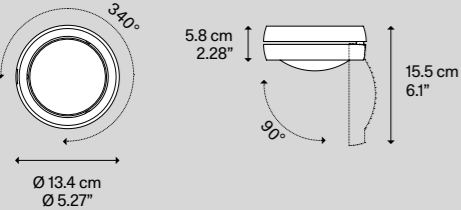

Light source Sorgente luminosa	Metal structure Montatura in metallo	Code Codice
LED ↘ 2700 K ↘ 12 W / 1115 lm ↘ 220-240 V ↘ CRI 90 ↘ MacAdam 3-Step LED included LED incluso	<ul style="list-style-type: none"> Matte White - 9010 Bianco Opaco - 9010 Matte Black - 9005 Nero Opaco - 9005 Chrome Cromo Matte Champagne Champagne Opaco 	165111 165112 165113 165133
or		
LED ↘ 3000 K ↘ 12 W / 1210 lm ↘ 220-240 V ↘ CRI 90 ↘ MacAdam 3-Step LED included LED incluso	<ul style="list-style-type: none"> Matte White - 9010 Bianco Opaco - 9010 Matte Black - 9005 Nero Opaco - 9005 Chrome Cromo Matte Champagne Champagne Opaco 	165114 165115 165116 165134



Adjustable light
Luce orientabile

Net weight / Peso netto: 1.10 kg Pack / Colli: 1

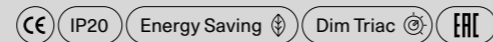

LED sources with direct power supply to the AC line voltage - driver not required. Dimmable with phase cut dimmer.

LED con alimentazione diretta a tensione di rete - non necessita di driver. Dimmerabile con varialuce a taglio di fase.

Nautilus Spot, design by Andrea Tosetto, 2020

Ceiling lamp

Nautilus Spot

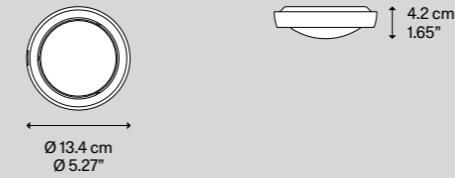

Light source Sorgente luminosa	Metal structure Montatura in metallo	Code Codice
LED ↘ 2700 K ↘ 10 W / 850 lm ↘ 220-240 V ↘ CRI 90 ↘ MacAdam 3-Step LED included LED incluso	<ul style="list-style-type: none"> Matte White - 9010 Bianco Opaco - 9010 Matte Black - 9005 Nero Opaco - 9005 Chrome Cromo Matte Champagne Champagne Opaco 	165135 165136 165137 165138
or		
LED ↘ 3000 K ↘ 10 W / 925 lm ↘ 220-240 V ↘ CRI 90 ↘ MacAdam 3-Step LED included LED incluso	<ul style="list-style-type: none"> Matte White - 9010 Bianco Opaco - 9010 Matte Black - 9005 Nero Opaco - 9005 Chrome Cromo Matte Champagne Champagne Opaco 	165139 165140 165143 165144

Net weight / Peso netto: 0.56 kg Pack / Colli: 1

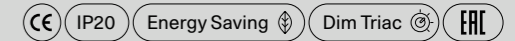

Nautilus, design by Andrea Tosetto, 2019

Suspension lamp

Nautilus

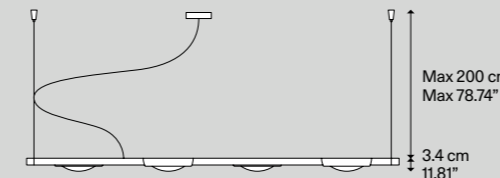
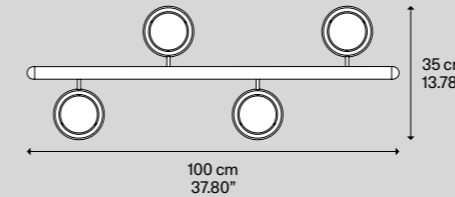

Light source Sorgente luminosa	Metal structure Montatura in metallo	Metal diffuser Diffusore in metallo	Code Codice
LED ↘ 2700 K ↘ 4 × 12 W / 4460 lm ↘ 220-240 V ↘ CRI 90 ↘ MacAdam 3-Step LED included LED incluso	<ul style="list-style-type: none"> Chrome Cromo 	<ul style="list-style-type: none"> Matte White - 9010 Bianco Opaco - 9010 Matte Black - 9005 Nero Opaco - 9005 Chrome Cromo 	165117 165118 165119
or			
LED ↘ 3000 K ↘ 4 × 12 W / 4840 lm ↘ 220-240 V ↘ CRI 90 ↘ MacAdam 3-Step LED included LED incluso	<ul style="list-style-type: none"> Chrome Cromo 	<ul style="list-style-type: none"> Matte White - 9010 Bianco Opaco - 9010 Matte Black - 9005 Nero Opaco - 9005 Chrome Cromo 	165120 165121 165122

Net weight / Peso netto: 4.43 kg Pack / Colli: 1

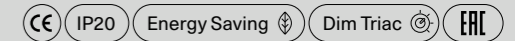

LED sources with direct power supply to the AC line voltage - driver not required. Dimmable with phase cut dimmer.

LED con alimentazione diretta a tensione di rete - non necessita di driver. Dimmerabile con varialuce a taglio di fase.

Rain

Rain falls from the ceiling like a drop of spring rain, with a linear movement that accentuates the curvaceous conical forms of its body. A metal suspension lamp with an LED light source – simple and effective, elegant and extremely bright, to be used either independently or as a scenic composition.

Rain scende dal soffitto come una goccia di pioggia primaverile, con un movimento lineare che accentua le sinuose forme coniche del suo corpo. Una sospensione in metallo con sorgente luminosa a LED – semplice ed efficace, elegante ed estremamente luminosa, da usare da sola o in composizioni scenografiche.

Cluster suspension lamp

Rain, FINISHES Matte Black + Matte Black
and Matte Black + Coppery Bronze

Rain, *design by* Andrea Tosetto, 2015





Rain, Round Cluster System, composition of 5 lights and Recessed Canopies

FINISHES Matte Black + Matte Black and Matte Black + Chrome



Rain, FINISHES Chrome + Coppery Bronze, Chrome + Gold, Chrome + Rose Gold and Chrome + Matte Black

Rain, *Round Cluster System*, composition of 36 lights



Rain, special composition of 287 lights,
FINISH Matte Black + Gold



Rain, FINISH Chrome + Matte Black



Rain, FINISH Chrome + Rose Gold



Rain, FINISH Chrome + Brushed Chrome

Rain, une goutte de pluie printanière descend du plafond, avec un mouvement linéaire qui accentue les sinueuses formes coniques de son corps. Une suspension en métal avec source lumineuse LED – simple et efficace, élégante et très lumineuse, à utiliser seule ou en compositions scénographiques. ●FR

Rain kommt von der Decke herab wie ein Regentropfen im Frühling, mit einer linearen Bewegung, die die geschwungenen, konischen Formen des Korpus betont. Eine Aufhängung aus Metall mit LED-Lichtquelle, einfach und effizient, elegant und besonders stark leuchtend, einzeln oder in wirkungsvollen Kombinationen zu verwenden. ●DE

Rain cae como una gota de lluvia primaveral del techo, con un movimiento lineal que acentúa las sinuosas formas cónicas de su cuerpo. Colgante de metal con fuente luminosa LED, simple y efectiva, elegante y extremadamente brillante, para usarla sola o en composiciones escénicas. ●ES

Светильник Rain спускается с потолка подобно капле весеннего дождя, прямолинейность падения которой оттеняет изгибы конических форм его корпуса. Металлический подвесной светильник с источником света LED – простой и эффективный, элегантный и необыкновенно яркий, для использования отдельно или в композициях со сценическим эффектом. ●RU

Rain就如从天花板上滴下的一滴春雨，以线性运动加重了其主体的弯曲圆锥形的外形。具有LED光源的金属悬架简单有效，优雅且非常明亮，可单独使用或在场景中组合使用。●ZH

Rain » Cluster suspension lamp

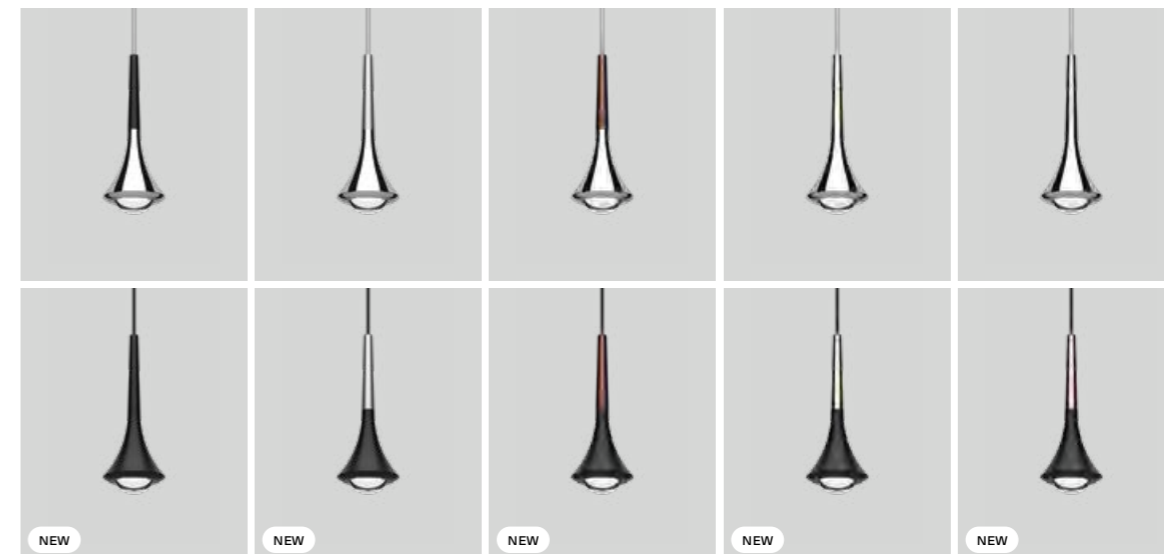

Cluster suspension lamp

Rain

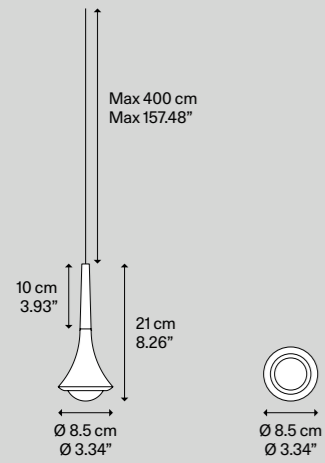

Light source Sorgente luminosa	Metal structure Montatura in metallo	Metal decor Decoro in metallo	Code Codice
LED ↘ 2700 K ↘ 9 W / 920 lm ↘ 220-240 V ↘ CRI 92 ↘ MacAdam 3-Step	Trasparent cable Cavo Trasparente	● Coppery Bronze Bronzo Ramato	156003
		● Gold Oro	156004
		● Rose Gold Oro Rosa	156005
		● Brushed Chrome Cromo Spazzolato	156002
		● Matte Black - 9005 Nero Opaco - 9005	156012
		● Coppery Bronze Bronzo Ramato	156019
		● Gold Oro	156025
		● Rose Gold Oro Rosa	156027
		● Brushed Chrome Cromo Spazzolato	156021
		● Matte Black - 9005 NEW Nero Opaco - 9005	156023
LED included LED incluso	Black cable Cavo Nero	● Coppery Bronze Bronzo Ramato	156015
		● Gold Oro	156018
		● Rose Gold Oro Rosa	156017
		● Brushed Chrome Cromo Spazzolato	156016
		● Matte Black - 9005 Nero Opaco - 9005	156014
		● Coppery Bronze Bronzo Ramato	156020
		● Gold Oro	156026
		● Rose Gold Oro Rosa	156028
		● Brushed Chrome Cromo Spazzolato	156022
		● Matte Black - 9005 NEW Nero Opaco - 9005	156024

Net weight/Peso netto: 0.34 kg

Pack/Colli: 2

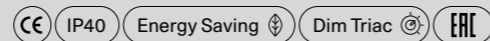

Suspension lamps must be installed on a canopy ▶ pag. 352-363
Le lampade a sospensione devono essere installate su rosone ▶ pag. 352-363

Example of composition

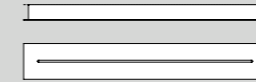

Short Lights Track

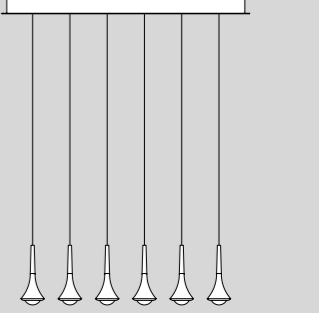
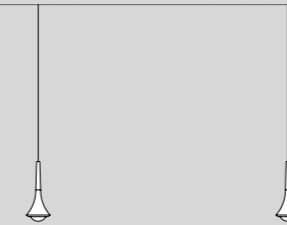

Example of composition

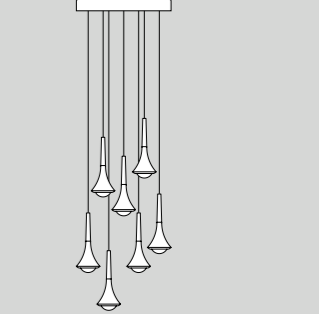
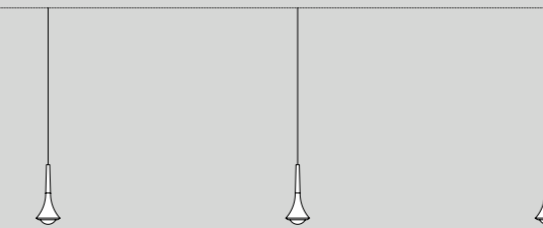
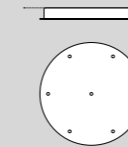

Example of composition

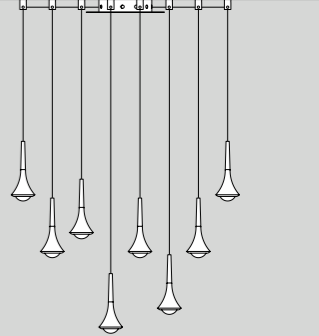
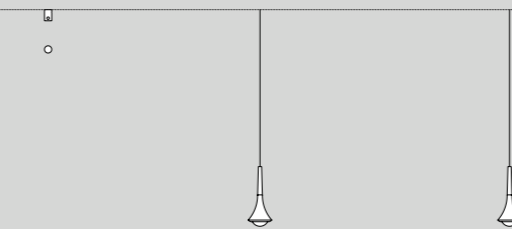
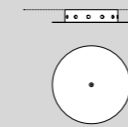

LED sources with direct power supply to the AC line voltage - driver not required. Dimmable with phase cut dimmer.

LED con alimentazione diretta a tensione di rete - non necessita di driver. Dimmerabile con varialuce a taglio di fase.

Spider

Spider is a round suspension lamp resembling an eye that can look into any part of the room. By adjusting the angle of the diffuser, the light beam emitted by the LED light can be directed towards any specific point. When installed on the different clusters available, it can create numerous lighting patterns, from functional to decorative, which can be dimmed at will. In Spider, the simplicity of the looks underscores the versatility of its performance.

Spider è una lampada a sospensione sferica che ricorda un occhio che può guardare in qualsiasi punto della stanza. Regolando l'angolo del diffusore si può infatti dirigere il fascio di luce a LED su un particolare punto di interesse, mentre montata sui diversi cluster disponibili può creare molteplici schemi di luce, dal funzionale al decorativo, dimmerabili a piacere. In Spider, la semplicità della forma esalta la versatilità delle prestazioni.

Cluster suspension lamp

Spider,
FINISHES Gold and Matte Black

Spider, *design by* Studio Italia Design, 2015





Spider, *Radial Cluster System*, composition of 6 lights, FINISH Matte Champagne



Spider, *Round Cluster System*, composition of 7 lights, FINISH Matte Black

Spider, *Radial Cluster System*,
composition of 6 lights, FINISH Chrome





Spider, FINISH Gold



Spider, *Radial Cluster System*,
composition of 14 lights, FINISH Gold

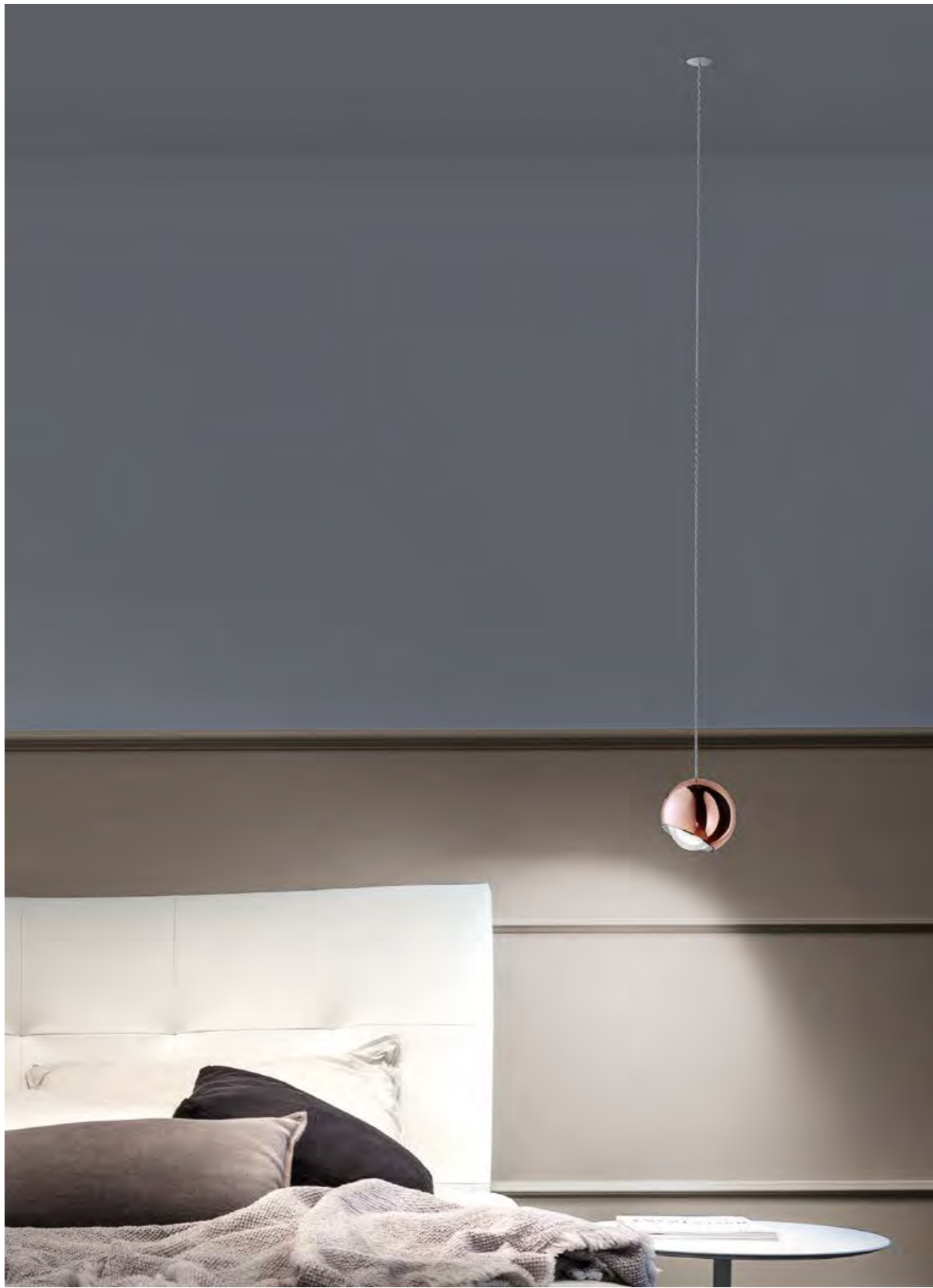

Spider, *Recessed Mirco Canopy*, FINISH Rose Gold



Spider, *Radial Cluster System*, composition of 4 lights, FINISH Matte Black



Spider, *Radial Cluster System*, composition of 10 lights, FINISH Matte White

Spider est une suspension sphérique qui fait penser à un œil qui peut regarder n'importe où dans la pièce. En réglant l'angle du diffuseur, vous pouvez en effet diriger le faisceau de lumière LED vers un point d'intérêt particulier, tandis que montée sur les différents clusters disponibles, elle peut créer plusieurs schémas d'éclairage, du fonctionnel au décoratif, variables à souhait. Dans Spider, la simplicité de la forme met en valeur la polyvalence des performances. ●FR

Spider ist eine kugelförmige Hängeleuchte, die an ein Auge erinnert, das jeden Punkt im Raum erblicken kann. Durch Einstellen des Winkels des Diffusors kann der LED-Lichtstrahl tatsächlich auf eine spezielle Stelle gerichtet werden, während durch die Kombination zu unterschiedlichen verfügbaren Clustern verschiedene Lichtschemata erstellt werden können - von funktionell bis dekorativ und nach Belieben dimmbar. Bei Spider betont die Einfachheit der Form die vielseitigen Leistungen. ●DE

Spider es una lámpara colgante esférica que recuerda un ojo que puede mirar a cualquier punto de la habitación. Regulando el ángulo del difusor, de hecho, se puede dirigir el haz de luz de LED en un punto particular de interés, mientras que instalada en los diferentes sistemas cluster disponibles puede crear múltiples esquemas de luz, desde el funcional al decorativo, regulable a gusto. En Spider, la simplicidad de la forma exalta la versatilidad de las prestaciones. ●ES

Spider – это сферический подвесной светильник, напоминающий глаз, который может смотреть в любую точку помещения. Регулируя угол диффузора, можно направлять пучок светодиодного света на конкретную точку, а при установке в различных кластерах – создавать разнообразные схемы освещения, от функционального до декоративного, с возможностью регулировки яркости. Простота формы Spider подчеркивает его универсальность. ●RU

Spider是一款球形吊灯，像一只眼睛，可以望向房间里的每一个角落。调节灯罩的角度，可以把LED灯的光束调向特定角度，如安装在不同的组合吊上，可营造多重光幕，可满足从功能性到装饰性的需求，并根据喜好调光。Spider的简单造型彰显了其性能的广泛用途。●ZH

Spider ▾ Cluster suspension lamp

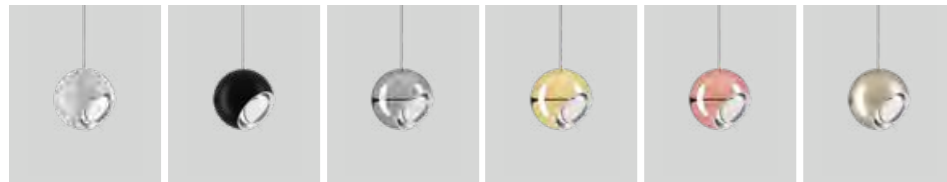

Spider, design by Studio Italia Design, 2015

Cluster suspension lamp

Spider

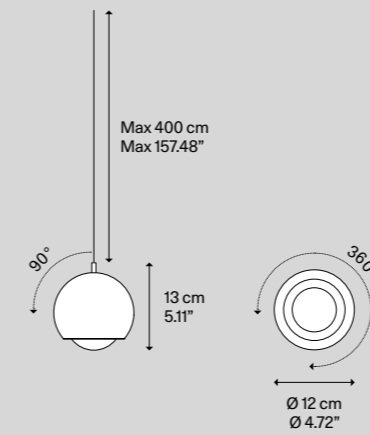

Light source Sorgente luminosa	Metal structure Montatura in metallo	Metal diffuser Diffusore in metallo	Code Codice
LED ▾ 2700 K ▾ 10 W/850 lm ▾ 220-240 V ▾ CRI 90 ▾ MacAdam 3-Step LED included LED incluso	Chrome Cromo	Matte White – 9010 Bianco Opaco – 9010	160006
		Matte Black – 9005 Nero Opaco – 9005	160007
LED ▾ 3000 K ▾ 10 W/925 lm ▾ 220-240 V ▾ CRI 90 ▾ MacAdam 3-Step LED included LED incluso	Chrome Cromo	Chrome Cromo	160008
		Gold Oro	160009
LED ▾ 3000 K ▾ 10 W/925 lm ▾ 220-240 V ▾ CRI 90 ▾ MacAdam 3-Step LED included LED incluso	Chrome Cromo	Rose Gold Oro Rosa	160010
		Matte Champagne Champagne Opaco	160016
LED ▾ 3000 K ▾ 10 W/925 lm ▾ 220-240 V ▾ CRI 90 ▾ MacAdam 3-Step LED included LED incluso	Chrome Cromo	Matte White – 9010 Bianco Opaco – 9010	160011
		Matte Black – 9005 Nero Opaco – 9005	160012
LED ▾ 3000 K ▾ 10 W/925 lm ▾ 220-240 V ▾ CRI 90 ▾ MacAdam 3-Step LED included LED incluso	Chrome Cromo	Chrome Cromo	160013
		Gold Oro	160014
LED ▾ 3000 K ▾ 10 W/925 lm ▾ 220-240 V ▾ CRI 90 ▾ MacAdam 3-Step LED included LED incluso	Chrome Cromo	Rose Gold Oro Rosa	160015
		Matte Champagne Champagne Opaco	160017

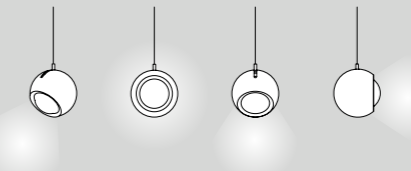

Adjustable light
Luce orientabile

Net weight/Peso netto: 0.8 kg

Pack/Colli: 2

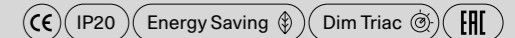

Suspension lamps must be installed on a canopy ▶ pag. 352-363
Le lampade a sospensione devono essere installate su rosone ▶ pag. 352-363

Example of composition

12 Lights Radial Cluster and Swag Kit for Radial Canopy

1 x 100027

8 x 130109

4 x 160010

4 x 160009

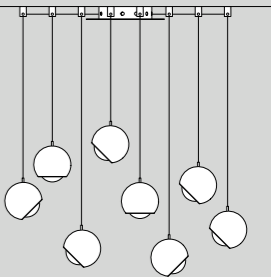
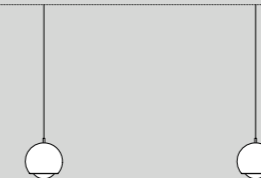

LED sources with direct power supply to the AC line voltage – driver not required. Dimmable with phase cut dimmer.

LED con alimentazione diretta a tensione di rete – non necessita di driver. Dimmerabile con varialuce a taglio di fase.

Pin-Up

A striking, compact light with a simple, organic design, Pin-Up opens like a shell to provide a bright light and the quality of LED lighting. A light that can be modelled at will thanks to the flexibility of the light fixture and the availability of two LED sources.

Una lampada compatta e sorprendente, dal design essenziale ed organico, Pin-Up si schiude come una conchiglia per illuminare gli spazi con la decisione e la qualità della luce a LED. Una luce che può essere modellata a piacere grazie alla flessibilità della lampada e alla disponibilità di due sorgenti LED.

Wall lamp, Ceiling lamp

Pin-Up,
FINISH Matte Black

Pin-Up, *design by* Andrea Tosetto, 2015





Pin-Up,
FINISH Coppery Bronze



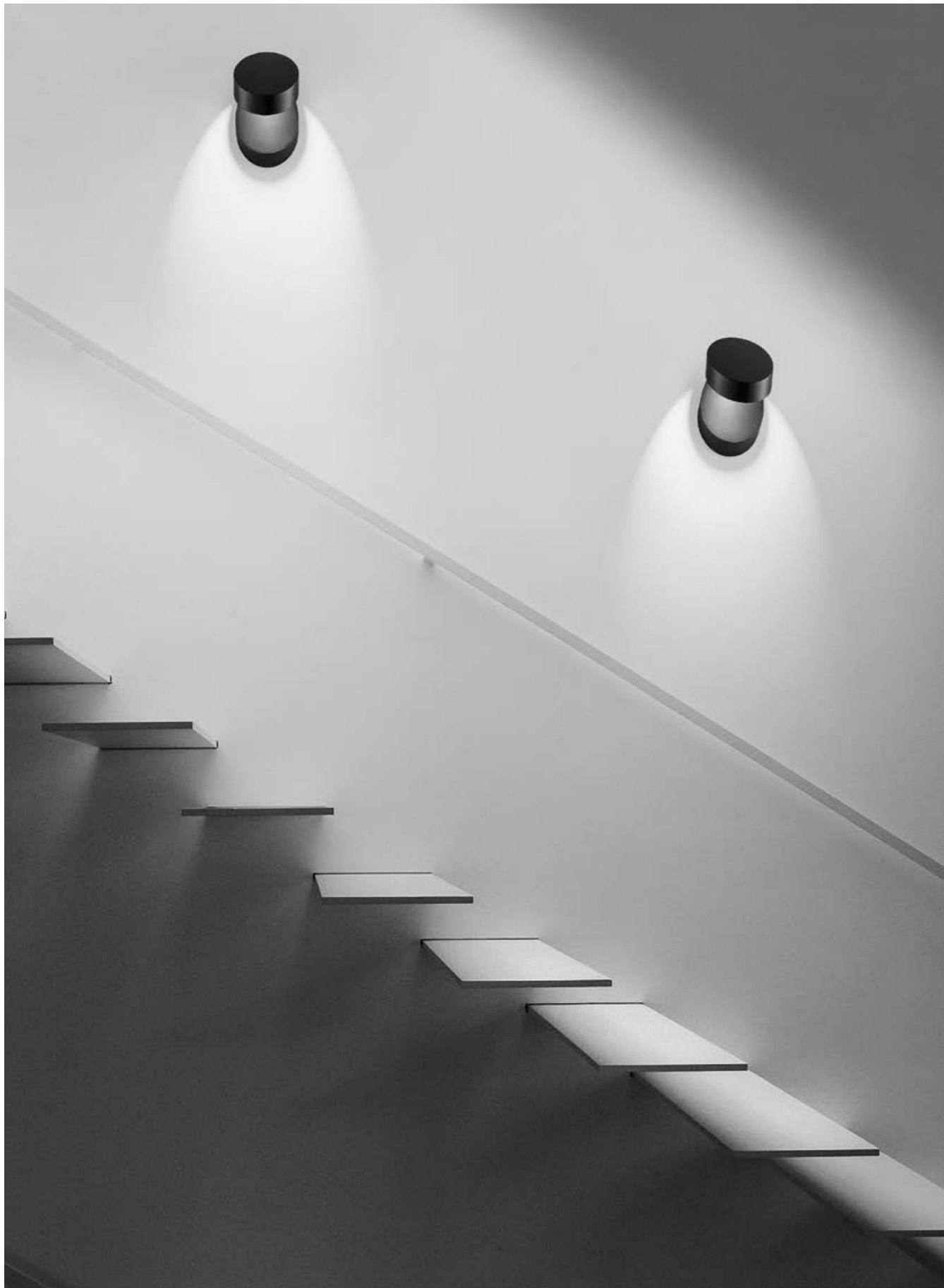

Pin-Up, FINISH Matte Black



Pin-Up, FINISH Matte White

Lampe compacte et surprenante, au design essentiel et organique, Pin-Up s'ouvre comme une coquille pour éclairer les espaces avec la précision et la qualité de la lumière LED. Une lumière qui peut être modelée à souhait grâce à la flexibilité de la lampe et à la disponibilité de deux sources LED. ●FR

Als eine kompakte und überraschende Lampe mit klarem, organischem Design schließt sich Pin-Up wie eine Muschel, um Räume mit der Entschlossenheit und Qualität von LED-Licht zu erhellen. Ein Licht, das dank der Flexibilität der Lampe und des Vorhandenseins von zwei LED-Quellen verändert werden kann. ●DE

Una lámpara compacta y sorprendente, de diseño esencial y orgánico, Pin-Up se abre como una concha para iluminar los espacios con la decisión y la calidad de la luz de LED. Una luz que puede ser modelada a gusto gracias a la flexibilidad de la lámpara y a la disponibilidad de dos fuentes de LED. ●ES

Pin-Up – изумительный компактный светильник со сдержанным, органичным дизайном. Открывается как ракушка и смело освещает пространство качественным светодиодным светом. Превосходная гибкость и наличие двух светодиодных источников позволяют моделировать освещение по желанию. ●RU

Pin-Up是一款紧凑而令人惊喜的灯具，设计简洁有序，如一个贝壳打开，以坚定而优质的LED灯光照亮空间。灯身灵活，配有两盏LED光源，灯光可随喜好调节。●ZH

Pin-Up, design by Andrea Tosetto, 2015

Wall lamp

Ceiling lamp

Pin-Up

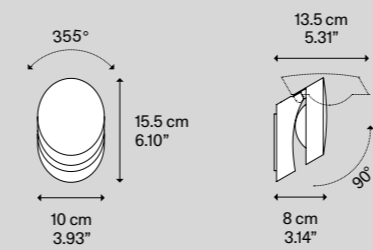

Light source Sorgente luminosa

LED
 ↘ 2700 K
 ↘ 9 W/920 lm
 ↘ 220-240 V
 ↘ CRI 92
 ↘ MacAdam 3-Step

or

LED
 ↘ 3000 K
 ↘ 9 W/980 lm
 ↘ 220-240 V
 ↘ CRI 92
 ↘ MacAdam 3-Step

LED included
 LED incluso

Metal structure Montatura in metallo

● Matte White - 9010
 Bianco Opaco - 9010

● Matte Coppery Bronze
 Bronzo Ramato Opaco

● Matte Black - 9005
 Nero Opaco - 9005

● Matte White - 9010
 Bianco Opaco - 9010

● Matte Coppery Bronze
 Bronzo Ramato Opaco

● Matte Black - 9005
 Nero Opaco - 9005

Code Codice

155001

155002

155008

155004

155005

155009



Adjustable light
Luce orientabile

Net weight/Peso netto: 1.15 kg

Pack/Colli: 1

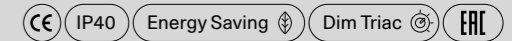

Pin-Up ↘ Wall lamp, Ceiling lamp

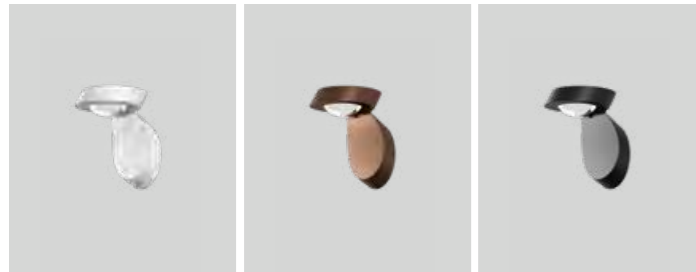

Bugia

Round, compact forms featuring elegant finishes with a centre that shines like a precious stone. Once lit up, Bugia amazes with the unexpected effect of its light. A surprising and harmonious balance between direct and indirect light, diffused both downward and up toward the ceiling. A rich family of ceiling lights, in Single, Double, Triple and now also Mega versions.

Forme rotonde compatte dalle finiture raffinate con un centro che splende come una pietra preziosa. Appena viene accesa, Bugia sorprende per l'effetto inaspettato della sua luce. Un inaspettato equilibrio armonico tra luce diretta e indiretta, diffusa sia verso il basso che verso il soffitto. Una ricca famiglia di plafoniere, in versione Single, Double, Triple e ora anche Mega.

Ceiling lamp

Bugia Triple and Mega,
FINISHES Chrome and Glossy Black

Bugia, *design by* Studio Italia Design, 2016/2020





Bugia Mega, FINISH White

Bugia Mega and Single,
FINISH White



Bugia Single, Double and Triple,
FINISH Glossy Black



Bugia Triple, FINISH Glossy Bronze



Bugia Single, FINISH Gold

Forme ronde compacte aux finitions raffinées avec un point central qui brille comme une pierre précieuse. Une fois allumée, Bugia surprend par l'effet inattendu de sa lumière. Un harmonieux équilibre inattendu entre lumière directe et indirecte, diffusée vers le bas ou vers le plafond. Une riche famille de plafonniers, en version Single, Double, Triple et maintenant Mega. ● FR

Kompakte, runde Formen mit raffinierten Ausführungen und einem Mittelpunkt, der wie ein Edelstein funkelt. Beim Einschalten überrascht Bugia durch den unerwarteten Effekt ihres Lichts. Ein unerwartet harmonisches Gleichgewicht zwischen direktem und indirektem Licht, das sowohl nach unten wie auch zur Decke gestrahlt wird. Eine ganze Familie von Deckenleuchten, in Single-, Double-, Triple- und jetzt auch Mega-Versionen. ● DE

Formas redondas compactas con acabados refinados con un centro que brilla como una piedra preciosa. Tan pronto como se enciende, Bugia sorprende con el inesperado efecto de su luz. Un inesperado equilibrio armónico entre la luz directa e indirecta, difusa tanto hacia abajo como hacia el techo. Una rica familia de lámparas de techo, en versiones Single, Double, Triple y ahora Mega. ● ES

Компактные круглые формы с изысканной отделкой, в центре которых как бы сияет драгоценный камень. Сразу же при включении светильник Bugia поражает своим потрясающим световым эффектом. Неожиданно уравновешенная гармония между прямым и непрямым светом, распространяющимся как вниз, так и к потолку. Богатая семья плафонов в вариации Single, Double, Triple и теперь Mega. ● RU

紧凑的圆形，精致的表面，中心像宝石一样闪闪发光。开启后，您会为Bugia灯光带来的意外效果感到惊讶。直射光和间接光之间出乎意料的和谐平衡，向下方并向天花板扩散。丰富的天花板灯家族系列，有Single, Double, Triple, 现在还有Mega版本。● ZH

Bugia Single ↘ Ceiling lamp

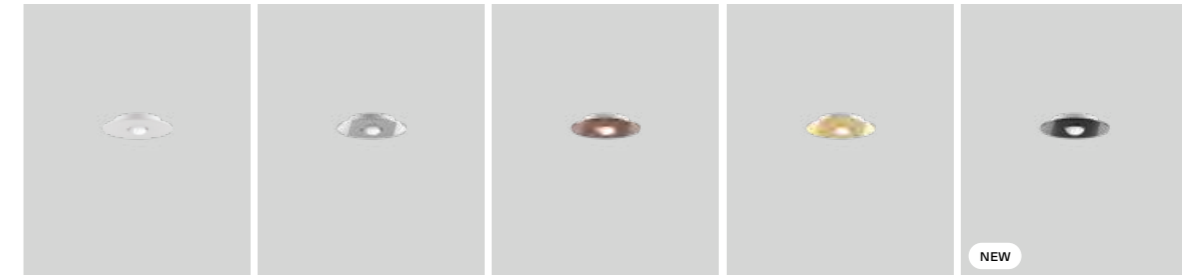

Bugia Double ↘ Ceiling lamp

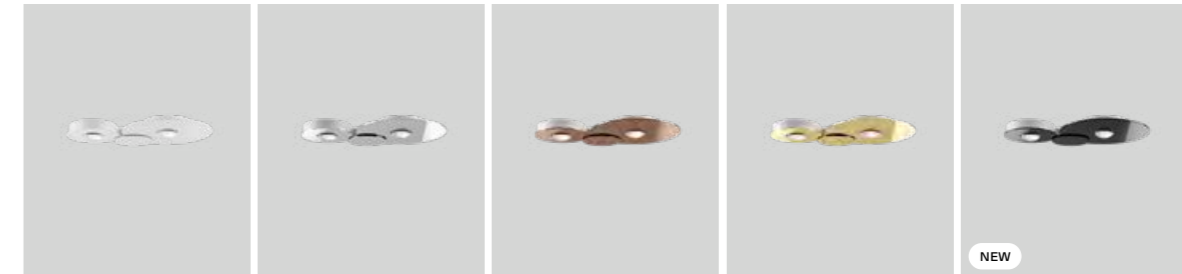

Bugia Triple ↘ Ceiling lamp



Bugia Mega ↘ Ceiling lamp **NEW LAMP**



Bugia, design by Studio Italia Design, 2016

Ceiling lamp

Bugia Single

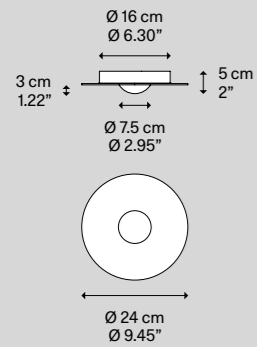

Light source Sorgente luminosa	Metal structure Montatura in metallo	Methacrylate diffuser Diffusore in metacrilato	Code Codice
LED ↘ 2700 K ↘ 15 W/1400 lm ↘ 220-240 V ↘ CRI 90 ↘ MacAdam 3-Step	● Matte White - 9010 Bianco Opaco - 9010	○ White Bianco	161025
		○ Gold Oro	161026
		○ Chrome Cromo	161027
		○ Glossy Bronze Bronzo Lucido	161028
		○ Glossy Black ^{NEW} Nero Lucido	161057
LED included LED incluso	○ or	○ White Bianco	161029
		○ Gold Oro	161030
		○ Chrome Cromo	161031
		○ Glossy Bronze Bronzo Lucido	161032
		○ Glossy Black ^{NEW} Nero Lucido	161058
LED ↘ 3000 K ↘ 15 W/1520 lm ↘ 220-240 V ↘ CRI 90 ↘ MacAdam 3-Step	● Matte White - 9010 Bianco Opaco - 9010	○ White Bianco	161033
		○ Gold Oro	161034
		○ Chrome Cromo	161035
		○ Glossy Bronze Bronzo Lucido	161036
		○ Glossy Black ^{NEW} Nero Lucido	161059
LED included LED incluso	○ or	○ White Bianco	161037
		○ Gold Oro	161038
		○ Chrome Cromo	161039
		○ Glossy Bronze Bronzo Lucido	161040
		○ Glossy Black ^{NEW} Nero Lucido	161060

Net weight/Peso netto: 0.8 kg

Pack/Colli: 2

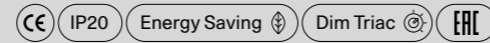

Bugia Double

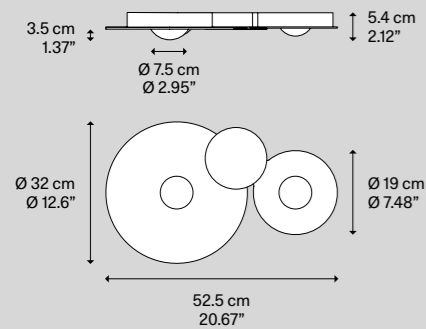

Light source Sorgente luminosa	Metal structure Montatura in metallo	Methacrylate diffuser Diffusore in metacrilato	Code Codice
LED ↘ 2700 K ↘ 2 x 15 W/2800 lm ↘ 220-240 V ↘ CRI 90 ↘ MacAdam 3-Step	● Matte White - 9010 Bianco Opaco - 9010	○ White Bianco	161033
		○ Gold Oro	161034
		○ Chrome Cromo	161035
		○ Glossy Bronze Bronzo Lucido	161036
		○ Glossy Black ^{NEW} Nero Lucido	161059
LED included LED incluso	○ or	○ White Bianco	161037
		○ Gold Oro	161038
		○ Chrome Cromo	161039
		○ Glossy Bronze Bronzo Lucido	161040
		○ Glossy Black ^{NEW} Nero Lucido	161060
LED ↘ 3000 K ↘ 2 x 15 W/3040 lm ↘ 220-240 V ↘ CRI 90 ↘ MacAdam 3-Step	● Matte White - 9010 Bianco Opaco - 9010	○ White Bianco	161033
		○ Gold Oro	161034
		○ Chrome Cromo	161035
		○ Glossy Bronze Bronzo Lucido	161036
		○ Glossy Black ^{NEW} Nero Lucido	161059
LED included LED incluso	○ or	○ White Bianco	161037
		○ Gold Oro	161038
		○ Chrome Cromo	161039
		○ Glossy Bronze Bronzo Lucido	161040
		○ Glossy Black ^{NEW} Nero Lucido	161060

Net weight/Peso netto: 2.05 kg

Pack/Colli: 2

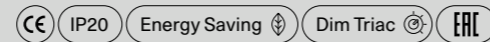

LED sources with direct power supply to the AC line voltage - driver not required. Dimmable with phase cut dimmer.

LED con alimentazione diretta a tensione di rete - non necessita di driver. Dimmerabile con varialuce a taglio di fase.

Bugia, design by Studio Italia Design, 2016

Ceiling lamp

Bugia Triple

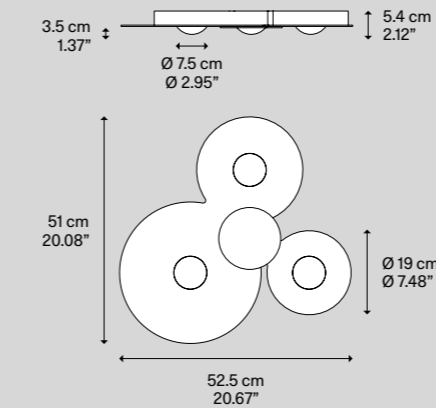

Light source Sorgente luminosa	Metal structure Montatura in metallo	Methacrylate diffuser Diffusore in metacrilato	Code Codice
LED ↘ 2700 K ↘ 3 x 15 W/4200 lm ↘ 220-240 V ↘ CRI 90 ↘ MacAdam 3-Step	● Matte White - 9010 Bianco Opaco - 9010	○ White Bianco	161041
		○ Gold Oro	161042
		○ Chrome Cromo	161043
		○ Glossy Bronze Bronzo Lucido	161044
		○ Glossy Black ^{NEW} Nero Lucido	161061
LED included LED incluso	○ or	○ White Bianco	161045
		○ Gold Oro	161046
		○ Chrome Cromo	161047
		○ Glossy Bronze Bronzo Lucido	161048
		○ Glossy Black ^{NEW} Nero Lucido	161062
LED ↘ 3000 K ↘ 3 x 15 W/4560 lm ↘ 220-240 V ↘ CRI 90 ↘ MacAdam 3-Step	● Matte White - 9010 Bianco Opaco - 9010	○ White Bianco	161041
		○ Gold Oro	161042
		○ Chrome Cromo	161043
		○ Glossy Bronze Bronzo Lucido	161044
		○ Glossy Black ^{NEW} Nero Lucido	161061
LED included LED incluso	○ or	○ White Bianco	161045
		○ Gold Oro	161046
		○ Chrome Cromo	161047
		○ Glossy Bronze Bronzo Lucido	161048
		○ Glossy Black ^{NEW} Nero Lucido	161062

Net weight/Peso netto: 2.8 kg

Pack/Colli: 2

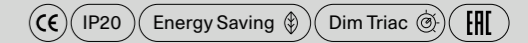

Bugia Mega, design by Studio Italia Design, 2020

Ceiling lamp

Bugia Mega ^{NEW}

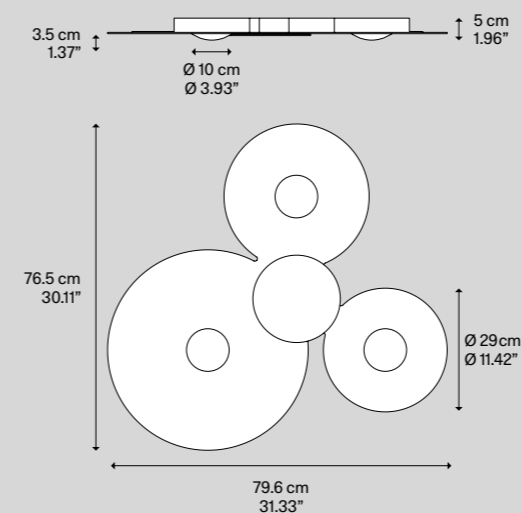

Light source Sorgente luminosa	Metal structure Montatura in metallo	Methacrylate diffuser Diffusore in metacrilato	Code Codice
LED ↘ 2700 K ↘ 3 x 15 W/4200 lm ↘ 220-240 V ↘ CRI 90 ↘ MacAdam 3-Step	● Matte White - 9010 Bianco Opaco - 9010	○ White Bianco	161049
		○ Gold Oro	161050
		○ Chrome Cromo	161051
		○ Glossy Bronze Bronzo Lucido	161052
		○ Glossy Black ^{NEW} Nero Lucido	161063
LED included LED incluso	○ or	○ White Bianco	161053
		○ Gold Oro	161054
		○ Chrome Cromo	161055
		○ Glossy Bronze Bronzo Lucido	161056
		○ Glossy Black ^{NEW} Nero Lucido	161064
LED ↘ 3000 K ↘ 3 x 15 W/4560 lm ↘ 220-240 V ↘ CRI 90 ↘ MacAdam 3-Step	● Matte White - 9010 Bianco Opaco - 9010	○ White Bianco	161049
		○ Gold Oro	161050
		○ Chrome Cromo	161051
		○ Glossy Bronze Bronzo Lucido	161052
		○ Glossy Black ^{NEW} Nero Lucido	161063
LED included LED incluso	○ or	○ White Bianco	161053
		○ Gold Oro	161054
		○ Chrome Cromo	161055
		○ Glossy Bronze Bronzo Lucido	161056
		○ Glossy Black ^{NEW} Nero Lucido	161064

Net weight/Peso netto: 4.4 kg

Pack/Colli: 2

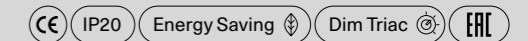

LED sources with direct power supply to the AC line voltage - driver not required. Dimmable with phase cut dimmer.

LED con alimentazione diretta a tensione di rete - non necessita di driver. Dimmerabile con varialuce a taglio di fase.

A–Tube Nano

A–Tube Nano is a suspension lamp which interprets light in its simplest form by creating a thin luminous line in the living spaces. At the lower end of the lightweight aluminium structure, a transparent methacrylate diffuser houses an LED module whose light creates a soft, welcoming atmosphere. The three sizes and six statement finishes allow to create clusters of evocative lighting.

A–Tube Nano è una lampada a sospensione che interpreta la luce nella sua forma più essenziale disegnando una sottile linea luminosa nello spazio abitativo. All'estremità inferiore della leggera struttura in alluminio, un diffusore in metacrilato trasparente ospita un modulo LED la cui luce crea un'atmosfera morbida e avvolgente. Le tre dimensioni e le sei distinte finiture permettono di realizzare suggestive composizioni su cluster.

Cluster suspension lamp

A–Tube Nano small, medium and large,
Round Cluster System, composition of 5 lights,
FINISH Matte White

A–Tube Nano, *design by Studio Italia Design*, 2016





A-Tube Nano large, *Single Mini Canopies*,
FINISH Matte Champagne



A-Tube Nano medium and large, *Recessed Micro Canopies*, FINISHES Matte Black and Gold



A-Tube Nano small, medium and large, *Round Cluster System*, 2 × compositions of 7 lights, FINISH Gold



A-*Tube Nano medium, Round Cluster System*, composition of 5 lights, FINISH Matte Black

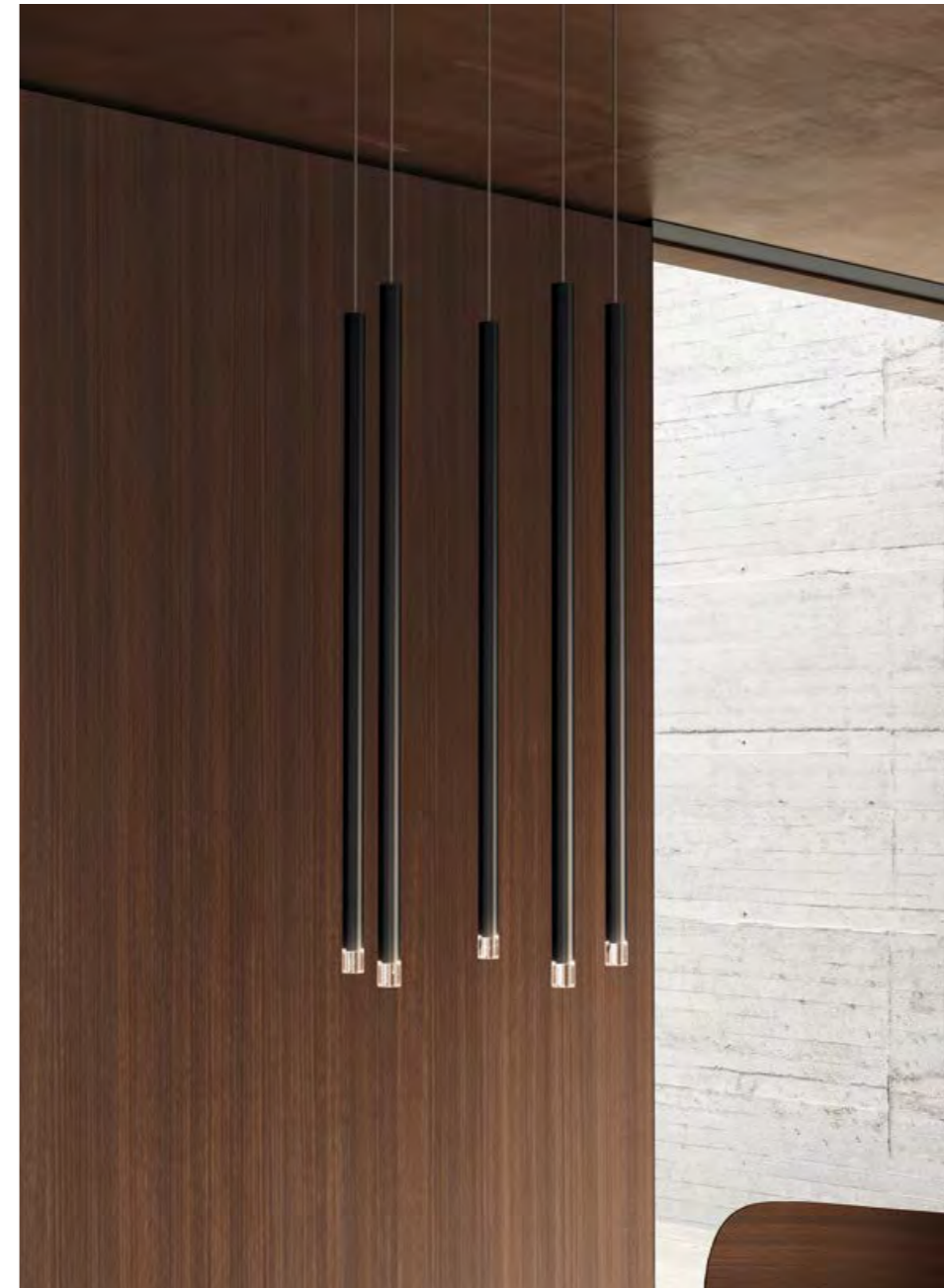

A-*Tube Nano medium*, FINISH Matte Black



A-Tube Nano small, medium and large,
Rectangular Cluster System, composition of 14
 lights, FINISH Rose Gold



A-Tube Nano small, medium and large, *Round Cluster System*, composition of 36 lights, FINISH Rose Gold



A-Tube Nano small, medium and large, composition of 14 lights FINISH Chrome

A-Tube Nano est une suspension qui interprète la lumière dans sa forme la plus essentielle en dessinant une fine ligne lumineuse dans l'espace de vie. À l'extrémité inférieure de la structure en aluminium léger, un diffuseur en méthacrylate transparent abrite un module LED dont la lumière crée une atmosphère douce et enveloppante. Les trois dimensions et les six finitions distinctes permettent de créer des compositions suggestives en cluster. ●FR

A-Tube Nano ist eine Hängeleuchte, die das Licht in seiner einfachsten Form interpretiert und für einen schmalen Lichtstreifen im Wohnraum sorgt. Am unteren Ende der leichten Armatur aus Aluminium enthält ein Diffusor aus Methacrylat ein LED-Modul, dessen Licht eine angenehme und umhüllende Atmosphäre entstehen lässt. Die drei Größen und sechs unterschiedlichen Ausführungen ermöglichen die Umsetzung zauberhafter Kombinationen in Clustern. ●DE

A-Tube Nano es una lámpara colgante que interpreta la luz en su forma más esencial distinguiendo una delgada línea luminosa en el espacio habitable. En el extremo inferior de la estructura ligera de aluminio, un difusor de metacrilato transparente acoge un módulo LED cuya luz crea una atmósfera suave y envolvente. Las tres dimensiones y los seis diferentes acabados permiten realizar composiciones sugestivas en los grupos de lámparas colgantes. ●ES

A-Tube Nano – это подвесной светильник, который повторяет основную форму света, рисуя в жилом пространстве тонкую линию луча. В нижней части легкой алюминиевой конструкции в прозрачном диффузоре из метакрилата установлен светодиодный модуль, свет которого создает мягкую и обволакивающую атмосферу. Возможность выбора из трех размеров и шести различных отделок позволяет создавать потрясающие композиции на кластерах. ●RU

A-Tube Nano是一款吊灯，以简约的形式诠释灯光，在居住空间中勾勒出纤细的光线。在轻盈的铝材结构下端，安装了透明的甲基丙烯酸甲酯灯罩，内置LED模块，灯光营造柔和温馨的气氛。三种尺寸，六种颜色，可打造迷人的组合吊。●ZH

A-Tube Nano small ↘ Cluster suspension lamp

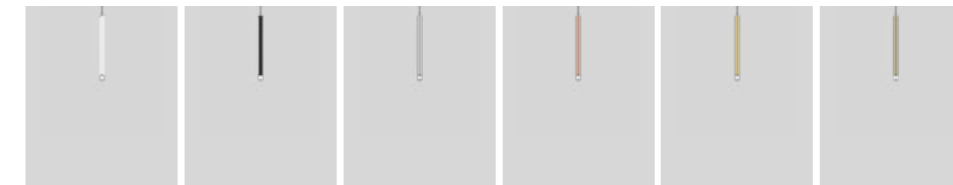

A-Tube Nano medium ↘ Cluster suspension lamp

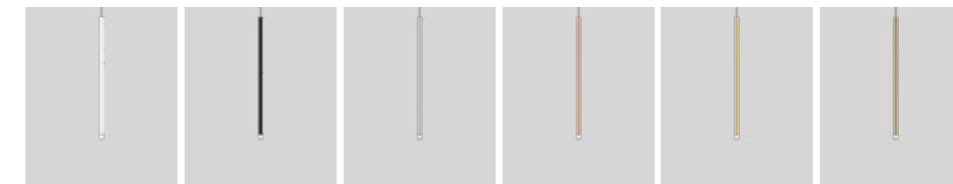

A-Tube Nano large ↘ Cluster suspension lamp

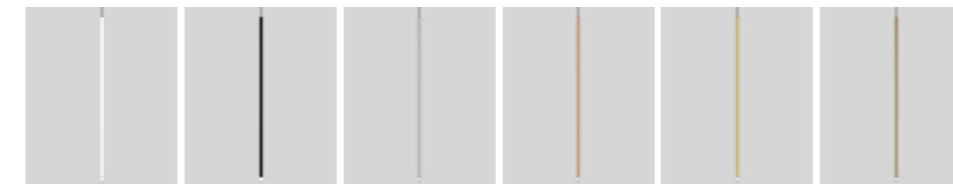

A-*Tube Nano*, design by Studio Italia Design, 2016

Cluster suspension lamp

A-*Tube Nano small*

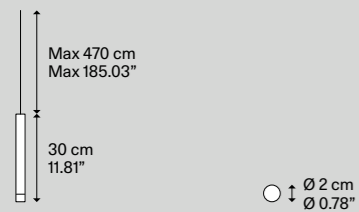

Light source Sorgente luminosa	Metal structure Montatura in metallo	Methacrylate diffuser Diffusore in metacrilato	Code Codice
LED ↘ 2700 K ↘ 3 W / 450 lm ↘ 350 mA ↘ CRI 90 ↘ MacAdam 3-Step	Matte White - 9010 Bianco Opaco - 9010	Clear Trasparente	158016
	Matte Black - 9005 Nero Opaco - 9005		158017
	Chrome Cromo		158018
LED and driver included LED e driver inclusi	Rose Gold Oro Rosa	Clear Trasparente	158019
	Gold Oro		158020
	Matte Champagne Champagne Opaco		158051
LED ↘ 3000 K ↘ 3 W / 480 lm ↘ 350 mA ↘ CRI 90 ↘ MacAdam 3-Step	Matte White - 9010 Bianco Opaco - 9010	Clear Trasparente	158036
	Matte Black - 9005 Nero Opaco - 9005		158038
	Chrome Cromo		158037
LED and driver included LED e driver inclusi	Rose Gold Oro Rosa	Clear Trasparente	158040
	Gold Oro		158039
	Matte Champagne Champagne Opaco		158054

Net weight/Peso netto: 0.25 kg

Pack/Colli: 2

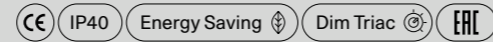

Suspension lamps must be installed on a canopy ▶ pag. 352-363
Le lampade a sospensione devono essere installate su rosone ▶ pag. 352-363

A-*Tube Nano*, design by Studio Italia Design, 2016

Cluster suspension lamp

A-*Tube Nano medium*



Light source Sorgente luminosa	Metal structure Montatura in metallo	Methacrylate diffuser Diffusore in metacrilato	Code Codice
LED ↘ 2700 K ↘ 3 W / 450 lm ↘ 350 mA ↘ CRI 90 ↘ MacAdam 3-Step	Matte White - 9010 Bianco Opaco - 9010	Clear Trasparente	158021
	Matte Black - 9005 Nero Opaco - 9005		158022
	Chrome Cromo		158023
LED and driver included LED e driver inclusi	Rose Gold Oro Rosa	Clear Trasparente	158024
	Gold Oro		158025
	Matte Champagne Champagne Opaco		158052
LED ↘ 3000 K ↘ 3 W / 480 lm ↘ 350 mA ↘ CRI 90 ↘ MacAdam 3-Step	Matte White - 9010 Bianco Opaco - 9010	Clear Trasparente	158041
	Matte Black - 9005 Nero Opaco - 9005		158042
	Chrome Cromo		158043
LED and driver included LED e driver inclusi	Rose Gold Oro Rosa	Clear Trasparente	158044
	Gold Oro		158045
	Matte Champagne Champagne Opaco		158055

Net weight/Peso netto: 0.3 kg

Pack/Colli: 2

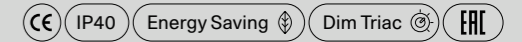

Suspension lamps must be installed on a canopy ▶ pag. 352-363
Le lampade a sospensione devono essere installate su rosone ▶ pag. 352-363

Cluster suspension lamp

A-*Tube Nano large*

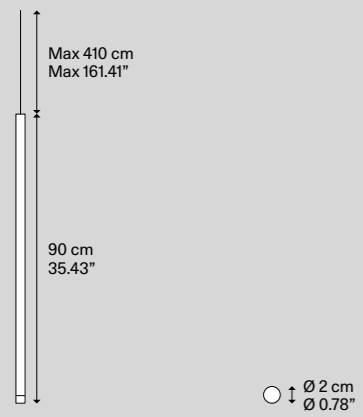

Light source Sorgente luminosa	Metal structure Montatura in metallo	Methacrylate diffuser Diffusore in metacrilato	Code Codice
LED » 2700 K » 3 W / 450 lm » 350 mA » CRI 90 » MacAdam 3-Step	Matte White - 9010 Bianco Opaco - 9010	Clear Trasparente	158026
	Matte Black - 9005 Nero Opaco - 9005		158027
LED and driver included LED e driver inclusi	Chrome Cromo	Clear Trasparente	158028
	Rose Gold Oro Rosa		158029
LED and driver included LED e driver inclusi	Gold Oro	Clear Trasparente	158030
	Matte Champagne Champagne Opaco		158053
LED » 3000 K » 3 W / 480 lm » 350 mA » CRI 90 » MacAdam 3-Step	Matte White - 9010 Bianco Opaco - 9010	Clear Trasparente	158046
	Matte Black - 9005 Nero Opaco - 9005		158047
LED and driver included LED e driver inclusi	Chrome Cromo	Clear Trasparente	158048
	Rose Gold Oro Rosa		158049
LED and driver included LED e driver inclusi	Gold Oro	Clear Trasparente	158050
	Matte Champagne Champagne Opaco		158056

Net weight/Peso netto: 0.59 kg

Pack/Colli: 2

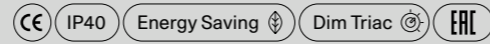

Suspension lamps must be installed on a canopy ► pag. 352-363
Le lampade a sospensione devono essere installate su rosone ► pag. 352-363

Example of composition

5 Lights Round Cluster

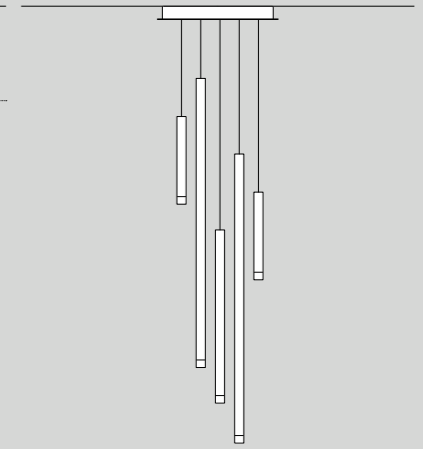
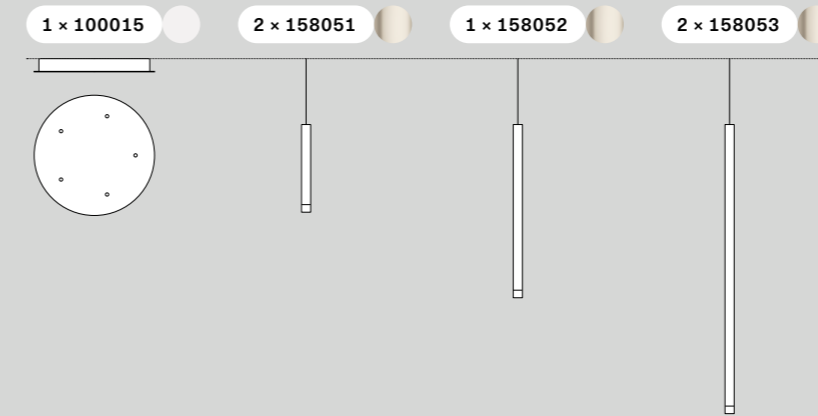

Example of composition

7 Lights Rectangular Cluster

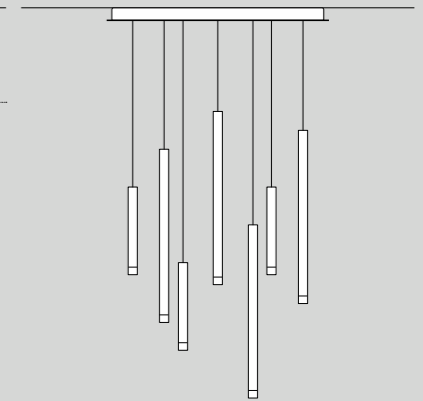
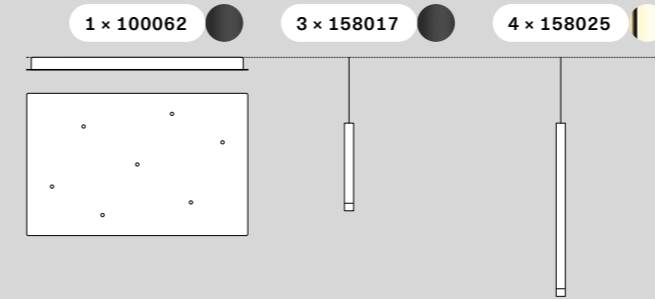

Example of composition

Short Lights Track

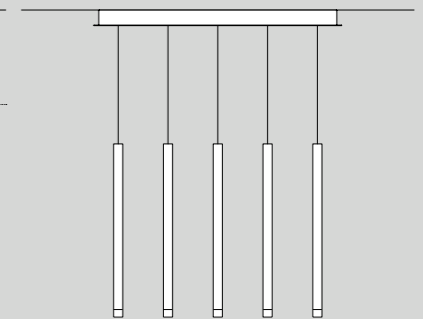
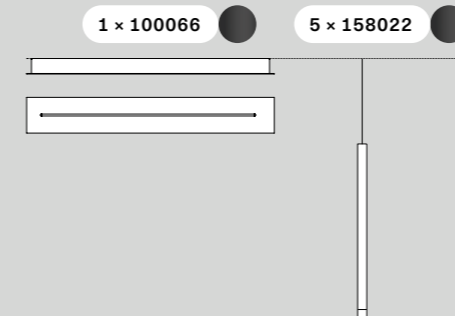

A-Tube Nano Duo

Precious pins suspended from a thin cable, like magic lights floating in the space. A-Tube Nano Duo is an offshoot of A-Tube Nano with an LED light source on both ends of its thin metal body. A lightweight and linear lamp available in six finishes, which allows to create evocative and playful cluster compositions.

Preziose barrette sospese ad un cavo sottile, come magiche luci che galleggiano nello spazio. A-Tube Nano Duo è una variante di A-Tube Nano con sorgente luminosa a LED su entrambe le estremità del sottile corpo metallico. Una lampada leggera e lineare disponibile in sei finiture, con le quali si possono realizzare suggestive e giocose composizioni su cluster.

Cluster suspension lamp

A-Tube Nano Duo, *Round Cluster System*,
composition of 7 lights,
FINISHES Chrome and Matte Black

A-Tube Nano Duo, *design by Studio Italia Design, 2017*



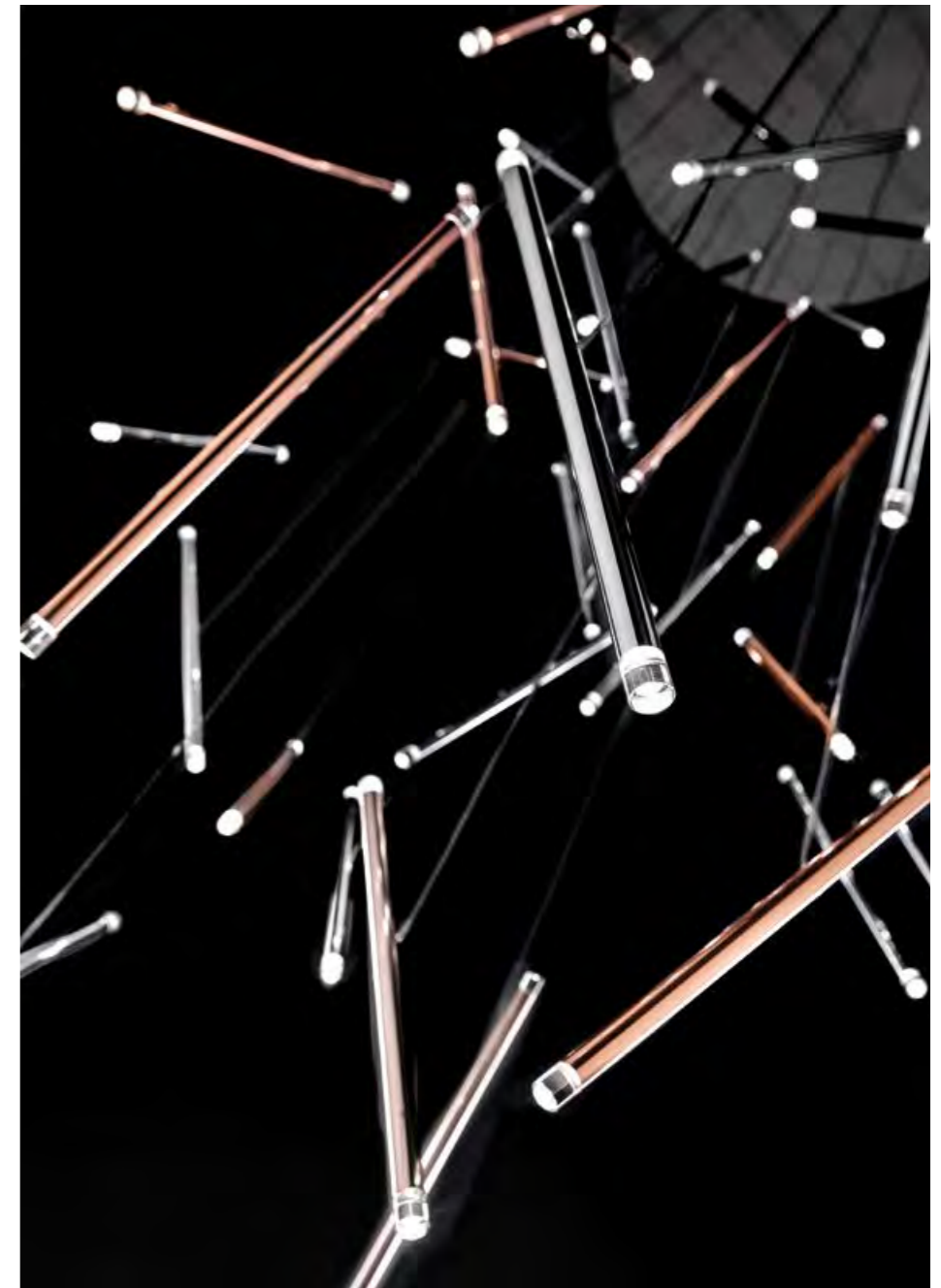

A-Tube Nano Duo, FINISHES Chrome and Rose Gold

A-Tube Nano Duo, *Round Cluster System*,
composition of 36 lights, FINISH Matte Champagne



A-*Tube Nano Duo, Rectangular Cluster System, 2 × compositions of 36 lights, FINISHES Chrome and Rose Gold*



A-Tube Nano Duo, special composition, FINISH Gold

De précieuses barres suspendues à un câble fin, comme des lumières magiques flottant dans l'espace. A-Tube Nano Duo est une variante de A-Tube Nano avec une source de lumière LED aux deux extrémités du fin corps métallique. Une lampe légère et linéaire disponible en six finitions, avec laquelle on peut créer des compositions multiples évocatrices et ludiques. ● FR

Wertvolle Balken, die an einem schmalen Kabel hängen, wie magisches Licht, das im Raum schwebt. A-Tube Nano Duo ist eine Variante von A-Tube Nano mit LED-Lichtquelle an beiden Enden des dünnen Metallkorpus. Eine leichte und lineare Leuchte, in sechs Ausführungen verfügbar, mit denen wunderbare und verspielte Cluster-Kombinationen geschaffen werden können. ● DE

Preciosas barras suspendidas de un cable delgado, como luces mágicas flotando en el espacio. A-Tube Nano Duo es una variante de A-Tube Nano con fuente luminosa LED en ambos extremos del fino cuerpo de metal. Una lámpara ligera y lineal disponible en seis acabados, con la que se pueden crear sugestivas y divertidas composiciones en grupos de lámparas colgantes. ● ES

Изящные трубки, подвешенные на тонком кабеле, – словно волшебные огни, парящие в пространстве. Светильник A-Tube Nano Duo является вариантом A-Tube Nano с источником света LED на обоих концах тонкого металлического корпуса. Легкая прямолинейная лампа доступна в шести вариантах отделки, с использованием которых можно создавать очаровательные и живые кластерные композиции. ● RU

通过细细的电缆线将贵重的条形悬挂起来，就像漂浮在太空中的魔幻灯一样。A-Tube Nano Duo是A-Tube Nano的变型，在纤薄金属主体的两端均带有LED光源。这是一种轻巧的线性灯，有六种颜色，可以在组合吊上创建富有启发性和趣味性的构造。● ZH

A-Tube Nano Duo » Cluster suspension lamp

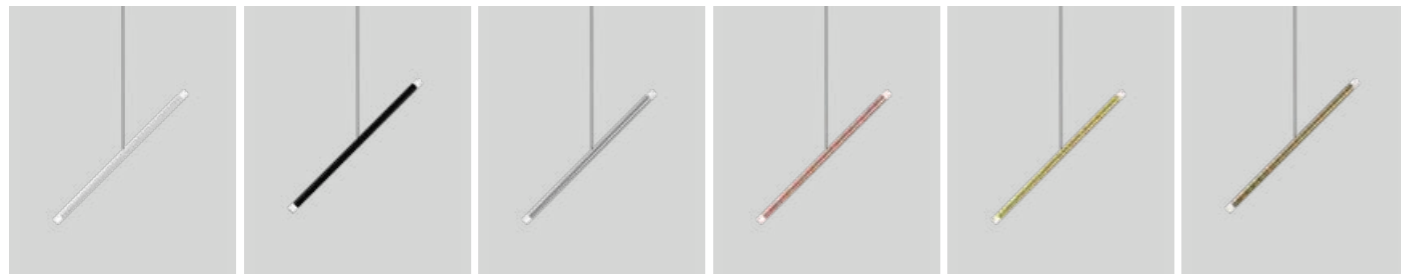

A-Tube Nano Duo, design by Studio Italia Design, 2017

Cluster suspension lamp

A-Tube Nano Duo

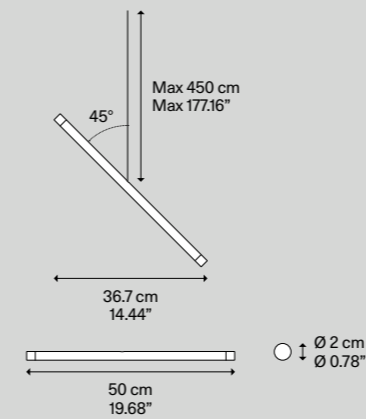

Light source
Sorgente luminosa

LED
 » 2700 K
 » 2 x 1 W/300 lm
 » 350 mA
 » CRI 90
 » MacAdam 3-Step

LED and driver included
 LED e driver inclusi

Metal structure
Montatura in metallo

- Matte White - 9010
Bianco Opaco - 9010
- Matte Black - 9005
Nero Opaco - 9005
- Chrome
Cromo
- Rose Gold
Oro Rosa
- Gold
Oro
- Matte Champagne
Champagne Opaco

Methacrylate diffuser
Diffusore in metacrilato

- Clear
Trasparente

Code
Codice

- 158031
- 158032
- 158033
- 158034
- 158035
- 158057

Net weight/Peso netto: 0.21 kg

Pack/Coll: 1

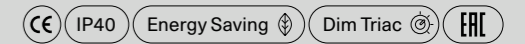

Suspension lamps must be installed on a canopy ► pag. 352-363
 Le lampade a sospensione devono essere installate su rosone ► pag. 352-363

Example of composition

5 Lights Round Cluster

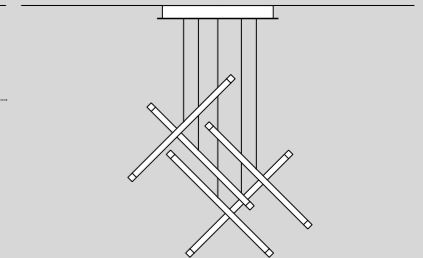
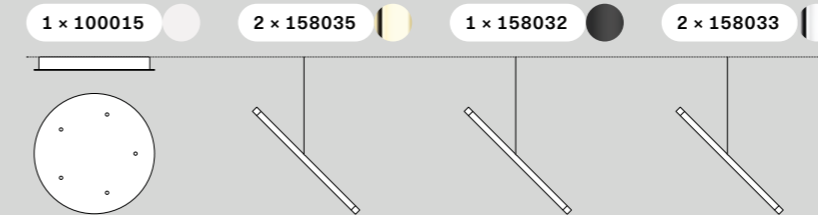

Example of composition

7 Lights Rectangular Cluster

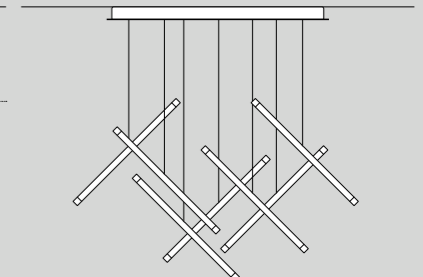
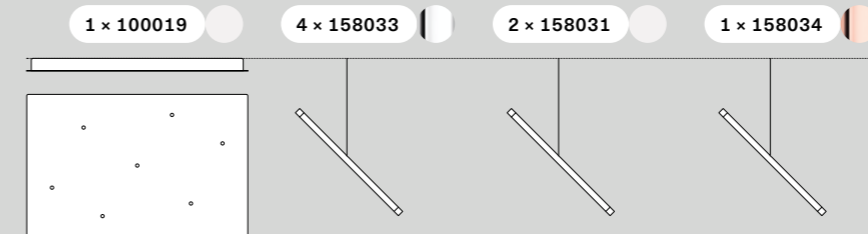

A-Tube

A simple form that delivers the light to wherever it's needed, enhancing the space. Tubular and slim, A-Tube is a versatile lamp available in four different sizes and three finishes. It can be fixed directly to the ceiling, suspended singularly, or used in cluster compositions to create impactful lighting effects.

Una forma semplice, che porta la luce dove si desidera valorizzando l'ambiente. Tubolare e sottile, A-Tube è una lampada versatile, disponibile in diverse dimensioni e in tre finiture. Può essere fissata direttamente al soffitto, sospesa singolarmente, oppure utilizzata in composizioni cluster d'effetto.

Cluster suspension lamp, Ceiling lamp

A-Tube small, medium and large,
Round Cluster System, composition of 3 lights,
FINISH Matte White

A-Tube, *design by* Studio Italia Design, 2013





A-Tube small and large, FINISH Matte Black



A-Tube mini, FINISH Matte Black

A-Tube mini,
FINISH Coppery Bronze

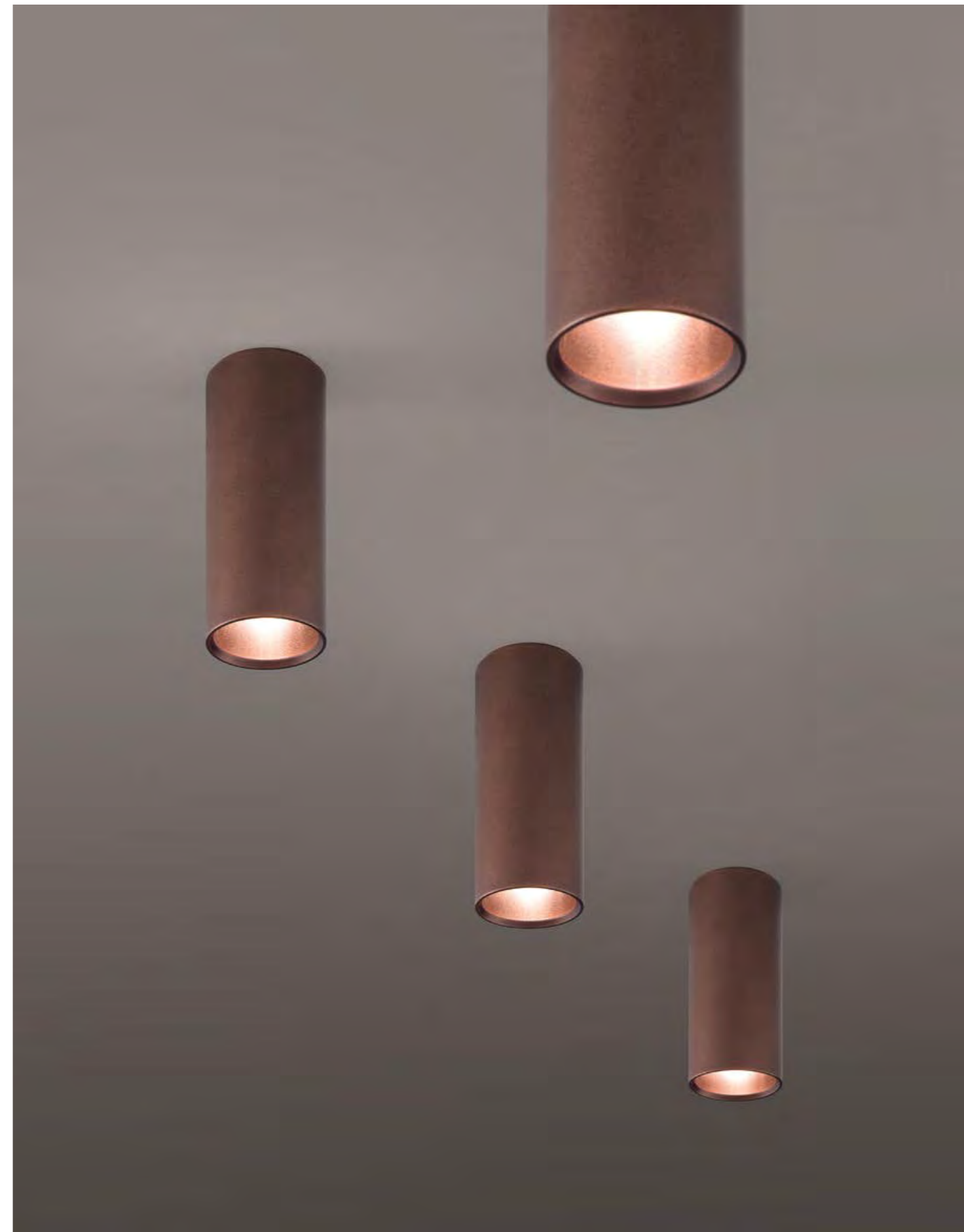



A-Tube small, medium and large, *Round Cluster System*, composition of 36 lights, FINISH Matte Black



A-Tube mini, small, medium and large,
FINISH Matte White

Une forme simple, qui éclaire où vous le souhaitez tout en valorisant l'environnement. Tubulaire et fine, A-Tube est une lampe polyvalente, disponible en différentes dimensions et trois finitions. Elle peut être fixée directement au plafond, suspendue individuellement ou utilisée en compositions cluster. ●FR

Una forma simple, que lleva la luz donde se desea valorizando el ambiente. Tubular y sutil, la A-Tube es una lámpara versátil, disponible en diferentes tamaños y tres acabados. Puede fijarse directamente al techo, suspenderse individualmente o utilizarse en composiciones de grupos de lámparas colgantes de efecto. ●ES

外形简洁，可将光线照射到想要的地方。A-Tube呈管状且细长，是一种多功能灯，有不同尺寸和三种颜色可供选择。它可以直接吸顶安装，可以单独悬吊安装，也可以组合吊式安装。●ZH

Eine einfache Form, die das Licht in jenen Bereich des Raums bringt, der betont werden soll. Röhrenförmig und dünn, ist A-Tube eine vielseitige Lampe, die in verschiedenen Größen und drei Ausführungen verfügbar ist. Sie kann direkt an der Decke befestigt werden, einzeln hängend, oder zu wirkungsvollen Clustern kombiniert. ●DE

Простая незамысловатая форма, несущая свет туда, где это необходимо, и украшающая интерьер. Светильник A-Tube в форме тонкой изящной трубки является необыкновенно универсальным и доступен с разными размерами и с тремя типами отделки. Его можно крепить непосредственно к потолку, повесить отдельно или использовать в качестве эффектных кластерных композиций. ●RU

A-Tube mini ↘ Ceiling lamp

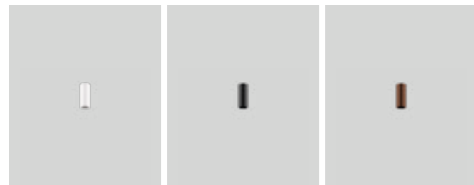

A-Tube small ↘ Ceiling lamp

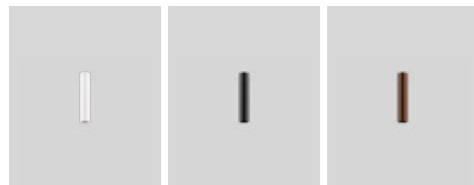

A-Tube small ↘ Cluster suspension lamp

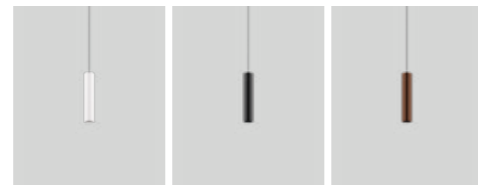

A-Tube medium ↘ Ceiling lamp

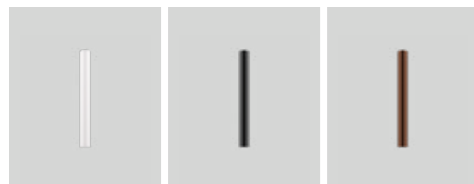

A-Tube medium ↘ Cluster suspension lamp

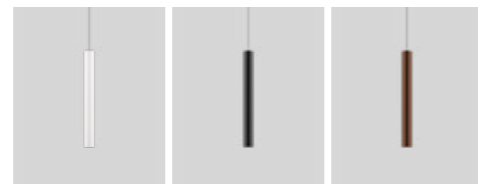

A-Tube large ↘ Ceiling lamp

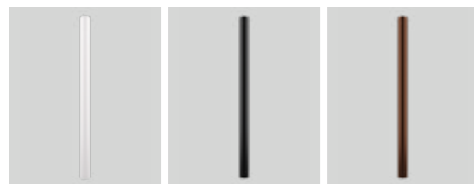

A-Tube large ↘ Cluster suspension lamp

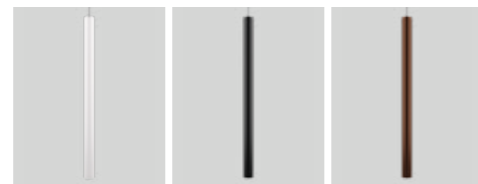

A-Tube, design by Studio Italia Design, 2013

Ceiling lamp

A-Tube mini

Ø 6 cm
Ø 2.36"



Light source
Sorgente luminosa

GU10 Par 16
↘ 1 × max 40W eco



or
GU10 Par 16 LED
↘ 1 × 10 W
(W/L max 9 cm)



Bulb not included
Lampadina non incusa

Metal structure
Montatura in metallo

Matte White - 9010
Bianco Opaco - 9010

or
Matte Black - 9005
Nero Opaco - 9005

Coppery Bronze
Bronzo Ramato

Code
Codice

096015

096030

096023

Net weight/Peso netto: 0.2 kg

Pack/Colli: 1

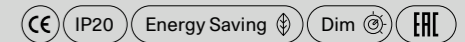

A-Tube small

Ø 6 cm
Ø 2.36"



GU10 Par 16
↘ 1 × max 40W eco



or
GU10 Par 16 LED
↘ 1 × 10 W
(W/L max 9 cm)



Bulb not included
Lampadina non incusa

Matte White - 9010
Bianco Opaco - 9010

or
Matte Black - 9005
Nero Opaco - 9005

Coppery Bronze
Bronzo Ramato

096007

096031

096024

Net weight/Peso netto: 0.8 kg

Pack/Colli: 1

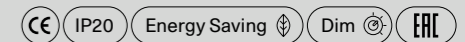

A-Tube medium

Ø 6 cm
Ø 2.36"



GU10 Par 16
↘ 1 × max 40W eco



or
GU10 Par 16 LED
↘ 1 × 10 W
(W/L max 9 cm)



Bulb not included
Lampadina non incusa

Matte White - 9010
Bianco Opaco - 9010

or
Matte Black - 9005
Nero Opaco - 9005

Coppery Bronze
Bronzo Ramato

096011

096033

096025

Net weight/Peso netto: 0.9 kg

Pack/Colli: 1

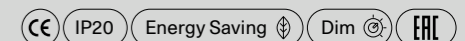

A-Tube large

Ø 6 cm
Ø 2.36"

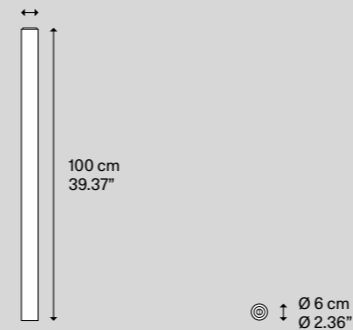

GU10 Par 16
↘ 1 × max 40W eco



or
GU10 Par 16 LED
↘ 1 × 10 W
(W/L max 9 cm)



Bulb not included
Lampadina non incusa

Matte White - 9010
Bianco Opaco - 9010

or
Matte Black - 9005
Nero Opaco - 9005

Coppery Bronze
Bronzo Ramato

096013

096035

096026

Net weight/Peso netto: 1.5 kg

Pack/Colli: 1

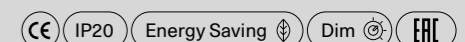

A-*Tube*, design by Studio Italia Design, 2013

Cluster suspension lamp

A-*Tube* small

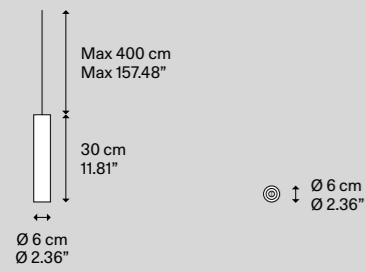

Net weight/Peso netto: 1.12 kg

Pack/Colli: 1

Light source
Sorgente luminosa

GU10 Par 16
≈ 1 × max 40W eco

or

GU10 Par 16 LED
≈ 1 × 10 W
(W/L max 8.5 cm)

Bulb not included
Lampadina non inclusa

Metal structure
Montatura in metallo

Matte White - 9010
Bianco Opaco - 9010

Matte Black - 9005
Nero Opaco - 9005

Coppery Bronze
Bronzo Ramato

Code
Codice

096057

096060

096063

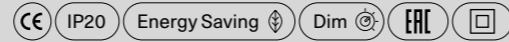

A-*Tube* medium

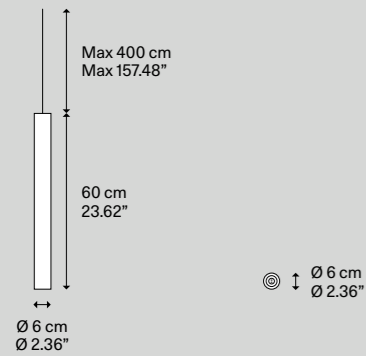

Net weight/Peso netto: 1.42 kg

Pack/Colli: 1

GU10 Par 16
≈ 1 × max 40W eco

or

GU10 Par 16 LED
≈ 1 × 10 W
(W/L max 8.5 cm)

Bulb not included
Lampadina non inclusa

Matte White - 9010
Bianco Opaco - 9010

Matte Black - 9005
Nero Opaco - 9005

Coppery Bronze
Bronzo Ramato

096058

096061

096064

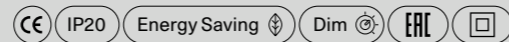

A-*Tube* large

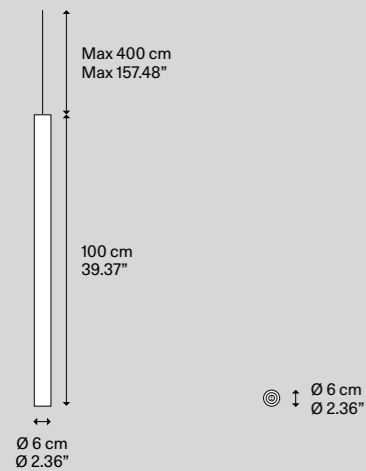

Net weight/Peso netto: 1.87 kg

Pack/Colli: 1

GU10 Par 16
≈ 1 × max 40W eco

or

GU10 Par 16 LED
≈ 1 × 10 W
(W/L max 8.5 cm)

Bulb not included
Lampadina non inclusa

Matte White - 9010
Bianco Opaco - 9010

Matte Black - 9005
Nero Opaco - 9005

Coppery Bronze
Bronzo Ramato

096059

096062

096065

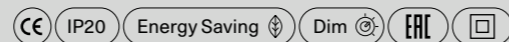

Suspension lamps must be installed on a canopy ► pag. 352-363
Le lampade a sospensione devono essere installate su rosone ► pag. 352-363

A-*Tube*, design by Studio Italia Design, 2013

Example of composition

5 Lights Round Cluster

1 × 100015 3 × 096058 2 × 096059

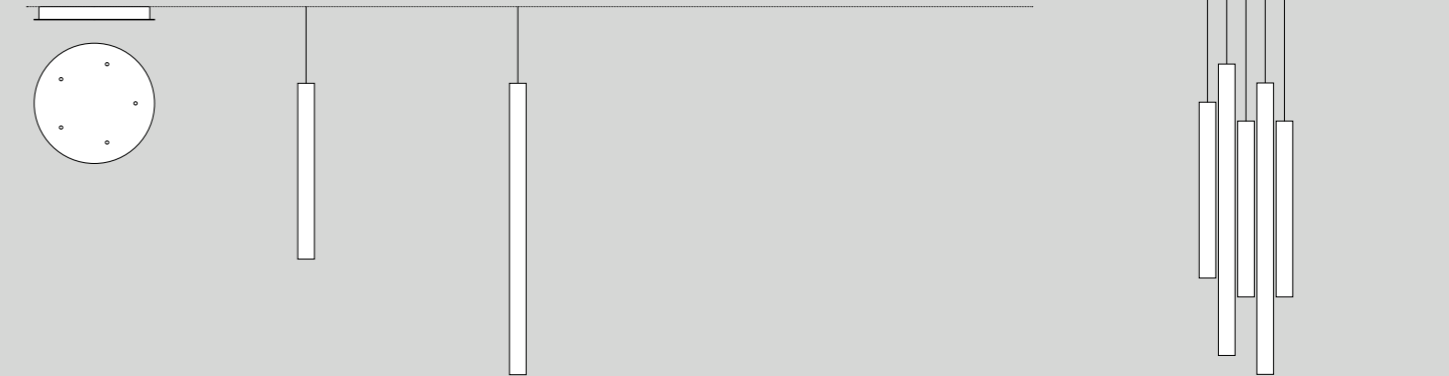

Example of composition

7 Lights Rectangular Cluster

1 × 100062 3 × 096060 2 × 096064 2 × 096061

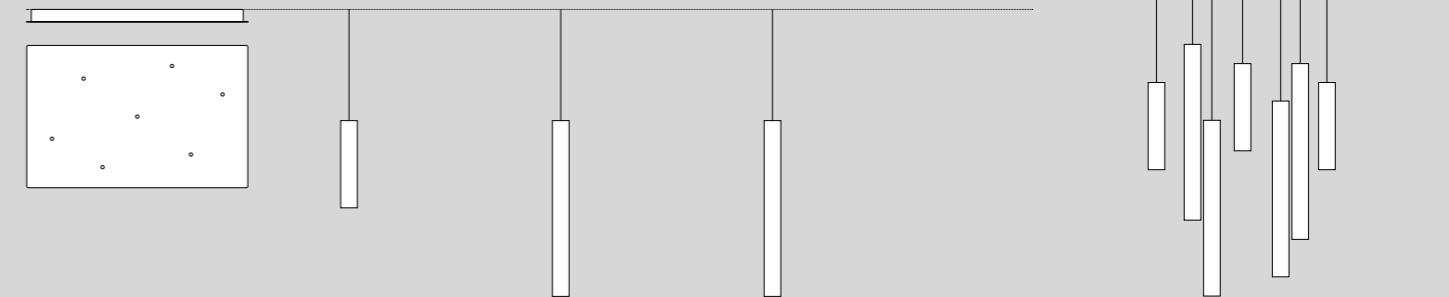

Example of composition

Short Lights Track

1 × 100066 5 × 096064

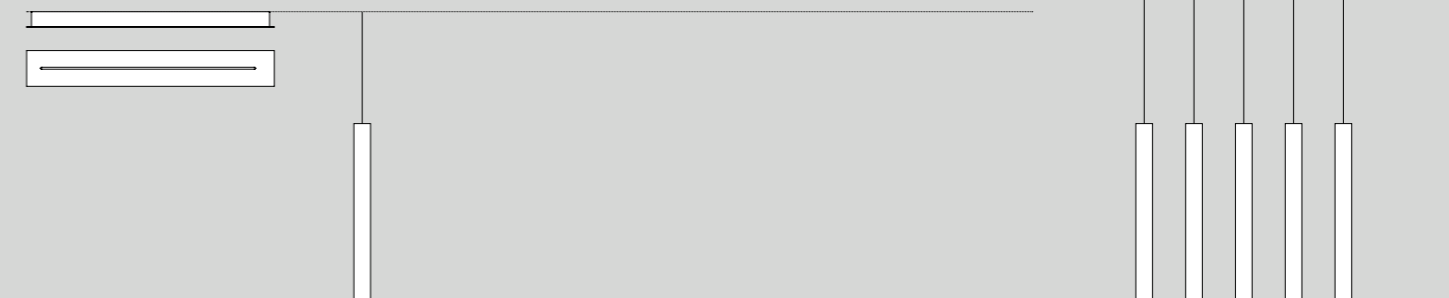

Cima

Inspired by the function of the jam cleats found in sailing boats, Cima – a nautical rope in Italian – is a “suspended” lamp characterised by a ceiling-to-floor rope, a sleek and highly functional design element. A joint that holds the lamp body slides vertically along the rope, while the counterweight allows to manage any excess rope. The simple cylindrical shapes and the black colour of these elements highlight the three brilliant finishes of the rope, vibrant accents to suit any interiors and décor mood.

Ispirata dalla funzione degli strozzascotte delle barche a vela, Cima è una lampada “sospesa” caratterizzata da una fune a tutt’altezza, elemento di design elegante e altamente funzionale. Lungo la fune scorre verticalmente un giunto che regge il corpo lampada, mentre il contrappeso permette di gestire l’eventuale fune in eccesso. Le semplici forme cilindriche e il colore nero di questi elementi risaltano le tre finiture brillanti della fune, accenti vibranti per qualsiasi ambiente e mood d’arredo.

Suspension lamp, Floor lamp

Cima,
FINISHES Yellow, Silver and Gold

Cima, *design by* Marco Dessì, 2021





Cima, FINISH Silver, set the rope at the desired length

Cima, FINISH Gold



Cima, FINISH Silver, counterweight / switch button on the power cord

Cima, FINISH Yellow





Cima, FINISH Silver

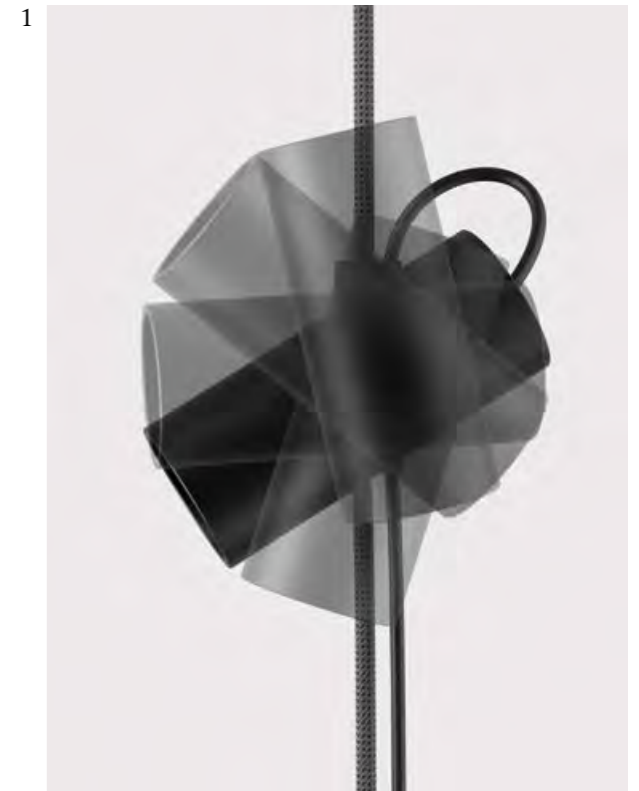

Cima, easy personalisation of light:
1-Change the angle of the lamp body

2-Adjust the height of the joint



Cima, FINISH Silver



Cima, FINISHES Silver, Gold and Yellow

S'inspirant de la fonction des taquets de blocage des voiliers, Cima – une corde nautique en italien – est une lampe « suspendue » caractérisée par une corde plafond-sol, élément de design élégant et fonctionnel. Le raccord qui supporte le corps de la lampe se déplace le long de la corde, tandis que le contrepoids permet d'ajuster l'excès de corde. Les formes cylindriques simples et la couleur noire de ces éléments mettent en valeur les trois finitions brillantes de la corde pour s'adapter à tous les intérieurs et à tous les styles de décoration. ● FR

Inspiriert von der Funktion der Klampen, die in Segelbooten zu finden sind, ist Cima – das bedeutet Schiffsseil auf Italienisch – eine „hängende Leuchte“, die sich durch ein Decken-Boden-Seil auszeichnet, ein elegantes und hoch funktionales Designelement. Entlang des Seils bewegt sich ein Gelenk, das den Lampenkörper stützt, während das Gegengewicht es ermöglicht, einen eventuellen Seilüberschuss zu justieren. Die schlichten Formen und die schwarze Farbe dieser Elemente unterstreichen die drei brillanten Ausführungen des Seils, vibrierende Akzente, die für jedes Interieur und jede Dekor Stimmung geeignet sind. ● DE

Inspirada en la función de las cornamusas que se encuentran en los veleros, Cima – una cuerda náutica en italiano – es una lámpara “suspendida” caracterizada por una cuerda que va del techo al suelo, un elemento de diseño elegante y sumamente funcional. A lo largo de la cuerda se mueve verticalmente una articulación que sujeta el cuerpo de la lámpara, mientras que el contrapeso permite reajustar cualquier exceso de cuerda. Las sencillas formas cilíndricas y el color negro de estos elementos resaltan los tres acabados brillantes de la cuerda, las notas vibrantes de cualquier interior y decoración de ambiente. ● ES

Вдохновленный функцией палубных стопоров, используемых на парусных лодках, светильник Cima – «корабельный канат» на итальянском – представляет собой подвешенную лампу, с тросом в полную высоту, задуманным как изысканный и высоко функциональный элемент дизайна. Вдоль троса вертикально перемещается шарнир, поддерживающий корпус лампы, а противовес позволяет отрегулировать избыток троса. Простые цилиндрические формы и черный цвет этих элементов подчеркивают три яркие отделки троса, вибрирующие тональности, подходящие для любых интерьеров и стилей. ● RU

受帆船中防滑钉的功能之启发,Cima—意大利语意为航海绳—是一款特征显著的“悬浮灯”,一条全高式绳索便是其优雅且功能强大的设计元素。一块用来举持灯体的接头沿绳索垂直延伸,而配重件则可让您调节管理绳索的任何多余之处。这些元素的简约圆柱形状与黑色突出了绳索的三种光鲜饰面,令任何室内环境与装饰风尚活力四射。● ZH

Cima, design by Marco Dessí, 2021

Suspension lamp

Floor lamp

Cima NEW

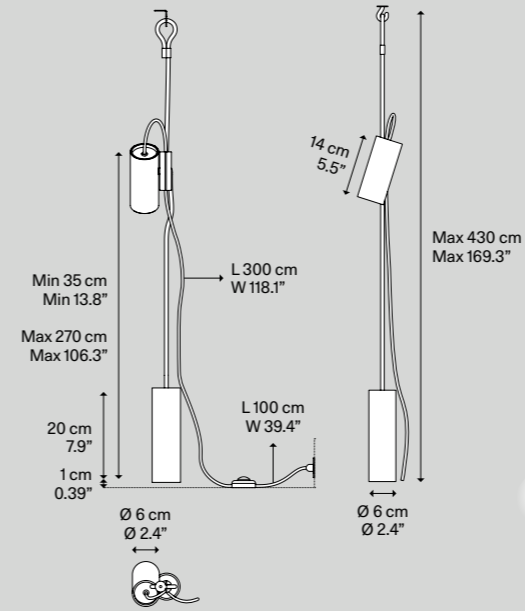

Light source Sorgente luminosa	Metal structure Montatura in metallo	Rope Corda	Code Codice
GU10 Par 16 LED ≈ 1 × 10 W III (W/L max 9 cm)	Matte Black Nero Opaco	Silver Argento	173001
		Gold Oro	173002
		Yellow Giallo	173003

Bulb not included
Lampadina non inclusa

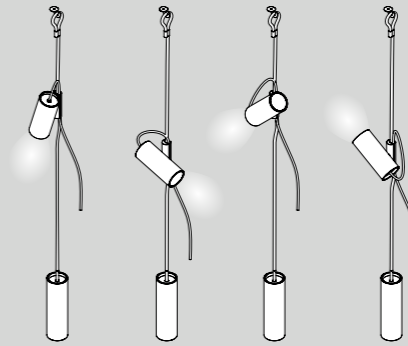

Adjustable light
Luce orientabile

Net weight/ Peso netto: 1.750 kg

Pack/Colli: 1

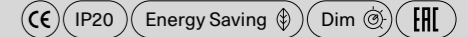

Cima ▾ Suspension lamp, Floor lamp **NEW LAMP**

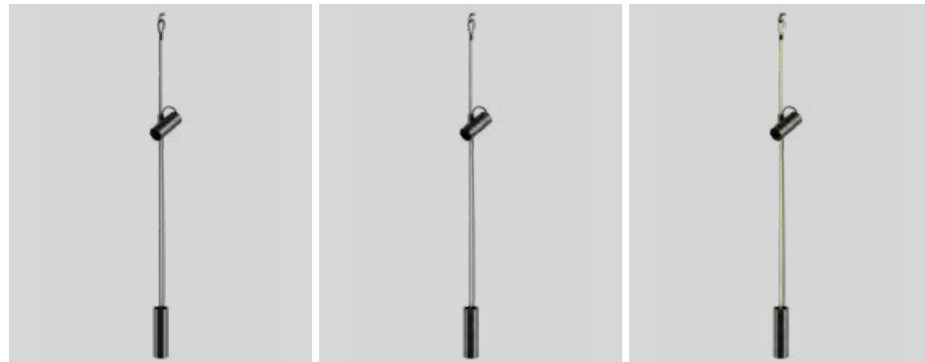

Finishes ▾ Rope

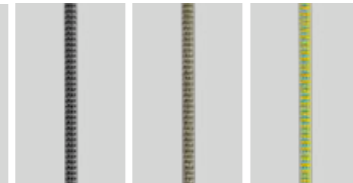

Blow

As light as a breath, Blow is an ethereal and original table lamp. Made from blown glass, it contains a bright light that can be directed inside the diffuser to create ever-different beams. Perfect for reading or furnishing personal and intimate spaces.

Leggera come un respiro, Blow è una lampada da tavolo eterea e ingegnosa. Realizzata in vetro soffiato, contiene una luce vivace che si può orientare all'interno del diffusore per creare fasci luminosi ogni volta diversi. Ideale per leggere e per arredare spazi personali e intimi.

Table lamp

Blow,
FINISH Clear

Blow, *design by* Pio & Tito Toso, 2005



Légère comme un souffle, Blow est une lampe sur table éthérée et ingénieuse. Réalisée en verre soufflé, elle renferme une lumière vivace qui peut être orienté à l'intérieur du diffuseur pour créer des faisceaux de lumière tous différents. Idéale pour la lecture et pour décorer les espaces personnels et intimes. ●FR

So leicht wie der Atem ist Blow eine himmlische und erfinderische Tischlampe. Hergestellt aus mundgeblasenem Glas, enthält die Leuchte ein lebhaftes Licht, das innen im Diffusor ausgerichtet werden kann, um stets neue Lichtstreifen entstehen zu lassen. Ideal zum Lesen und zum Einrichten persönlicher und intimer Räume. ●DE

Ligera como un suspiro, Blow es una etérea e ingeniosa lámpara de sobremesa. Fabricada en vidrio soplado, contiene una luz brillante que puede orientarse dentro del difusor para crear diferentes haces de luz cada vez. Ideal para leer y para decorar espacios personales e íntimos. ●ES

Легкий как дыхание, Blow – это изящный и очень оригинальный настольный светильник. Этот светильник, изготовленный из выдувного стекла, заключает в себе живой и динамичный свет, который можно ориентировать внутри диффузора для создания всякий раз других световых пучков. Идеально подходит для чтения и для оформления личных и интимных пространств. ●RU

轻如呼吸, Blow是一款灵动而巧妙的台灯。由吹制玻璃制成, 含有充满活力的光线, 可以将其定向到灯罩的内部, 每次发出不同的光束。阅读和布置个人和私密空间的理想之选。●ZH

Blow, design by Pio & Tito Toso, 2005

Table lamp

Blow

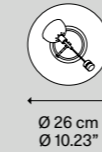
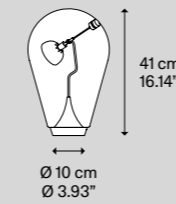

Light source Sorgente luminosa	Metal structure Montatura in metallo	Blown glass diffuser Diffusore in vetro soffiato	Code Codice
LED ↘ 2700 K ↘ 4.5 W / 500 lm ↘ 500 mA ↘ CRI 90 ↘ MacAdam 3-Step	Chrome Cromo	Clear Trasparente	008004

LED and driver included
LED e driver inclusi

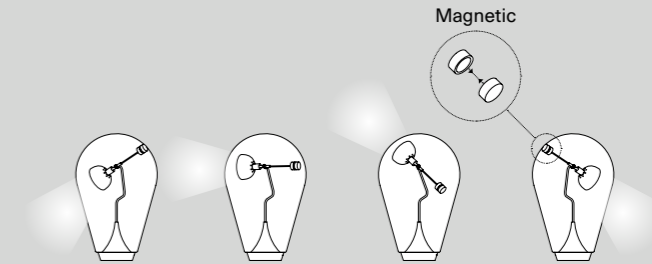

Adjustable light
Luce orientabile

Net weight / Peso netto: 4.00 kg

Pack / Colli: 1

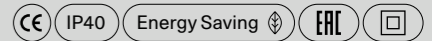

Blow ↘ Table lamp



Random Solo

Five perfect spheres floating in the air like gentle glass bubbles. Random Solo revisits the concept of the Random suspension lamp by parting the original three-piece cluster and adding two new blown glass spheres. The five sizes and six different finishes available offer ample styling freedom, both as individually suspended light points and in lightweight and lively combinations on clusters. The new fingerprint resistant frosted white finish magically changes the perception of the sphere and its volume, opening new opportunities for interior decoration.

Cinque sfere perfette che fluttuano nell'aria come leggere bolle di vetro. Random Solo rivisita il concetto della lampada a sospensione Random separando l'originale cluster a tre elementi e aggiungendo due nuove sfere in vetro soffiato. Le cinque dimensioni e le sei diverse finiture disponibili offrono ampia libertà di arredamento, sia come punti luce sospesi singolarmente che in leggere e vivaci composizioni multiple su cluster. La nuova finitura bianca satinata resistente alle impronte digitali cambia magicamente la percezione della sfera e del suo volume, aprendo nuove opportunità per la decorazione d'interni.

Cluster suspension lamp

Random Solo 28, 23 and 18,
FINISHES Frosted White, Glossy Smoke
and Clear

Random Solo, *design by Chia-Ying Lee, 2020*





Random Solo 12, 14, 18, 23 and 28, *Recessed Micro Canopies*, FINISHES Frosted White, Gold and Clear



Random Solo, FINISH Frosted White



Random Solo, FINISHES Glossy Smoke and Clear

Random Solo 23,
Track System, composition of 4 lights,
FINISH Frosted White





Random Solo 12, 14, 18, 23 and 28, FINISHES Clear and Glossy Smoke

Random Solo 23 and 28,
Round Cluster System, composition of 14 lights,
FINISHES Clear and Glossy Smoke



Random Solo 12, 14, 18, 23 and 28,
FINISHES Chrome and Clear



Random Solo 28 and 23, FINISHES Clear and Rose Gold

Random Solo 23 and 28,
Round Cluster System, composition of 5 lights,
FINISHES Clear and Rose Gold

Cinq sphères parfaites flottant dans l'air comme de légères bulles de verre. Random Solo revisite le concept de la lampe à suspension Random en séparant le cluster original à trois éléments et en ajoutant deux nouvelles sphères en verre soufflé. Les cinq tailles et les différentes finitions disponibles offrent une grande liberté d'aménagement, aussi bien sous forme de points lumineux suspendus individuellement que dans des compositions multiples légères et vivaces sur cluster. La nouvelle finition blanc satiné résistante aux empreintes digitales modifie comme par magie la perception de la sphère et de son volume, ouvrant de nouvelles possibilités pour la décoration d'intérieur. ● FR

Fünf perfekte Kugeln, die wie leichte Glasblasen in der Luft schweben. Random Solo ist das überarbeitete Konzept der Hängeleuchte Random, für die das originelle Cluster mit drei Elementen aufgeteilt wurde, um zwei neue Kugeln aus mundgeblasenem Glas hinzuzufügen. Die fünf Größen und sechs unterschiedlichen Ausführungen sorgen sowohl als einzeln hängende Lichtquellen wie auch als lebhaft Mehrfach-Kombinationen in Clustern für viel Freiheit beim Einrichten. Die neue, gegen Fingerabdrücke resistente Satin-Weiß Ausführung verändert auf magische Weise das Aussehen der Kugel und ihr Volumen und eröffnet neue Möglichkeiten für Innendekoration. ● DE

Cinco esferas perfectas que flucúan en el aire como ligeras bolas de vidrio. Random Solo reinterpreta el concepto de la lámpara colgante Random separando el original grupo de lámparas colgantes en tres elementos y añadiendo dos nuevas esferas en vidrio soplado. Las cinco dimensiones y los diversos acabados disponibles ofrecen amplia libertad de decoración, tanto como puntos de luz colgantes individualmente como en ligeras y vivaces composiciones múltiple en grupo de lámparas colgantes. El nuevo acabado blanco satinado resistente a las huellas dactilares cambia mágicamente la percepción de la esfera y su volumen, abriendo nuevas oportunidades para la decoración de interiores. ● ES

Пять шаров совершенной формы, плавающих в воздухе как легкие стеклянные пузыри. Random Solo переосмысливает концепцию подвесного светильника Random, разделяя оригинальный кластер из трех элементов и добавляя два новых шара из выдувного стекла. Предлагаемые пять размеров с различными вариантами отделки обеспечивают широкую свободу оформления интерьера, как в виде отдельно подвешенных световых точек, так и в виде ярких и живых кластерных композиций. Новая устойчивая к отпечаткам пальцев белая сатирированная отделка волшебным образом меняет восприятие сферы и ее объем, открывая новые возможности декорирования интерьера. ● RU

五个完美的球体漂浮在空中，如同轻盈的玻璃泡。Random Solo 是Random吊灯的改进设计，将原来的三单元组合吊分离，增加了两个新的吹制玻璃球。五种尺寸和不同的颜色提供了室内装饰的自由选择，即可作为单独的照明点位，也可以应用在轻盈活泼的组合吊不同搭配中。● ZH

Random Solo 12 Cluster suspension lamp **NEW LAMP**



Random Solo 14 Cluster suspension lamp **NEW LAMP**



Random Solo 18 Cluster suspension lamp **NEW LAMP**

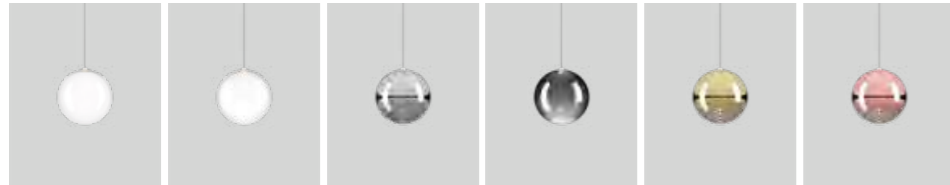

Random Solo 23 Cluster suspension lamp **NEW LAMP**

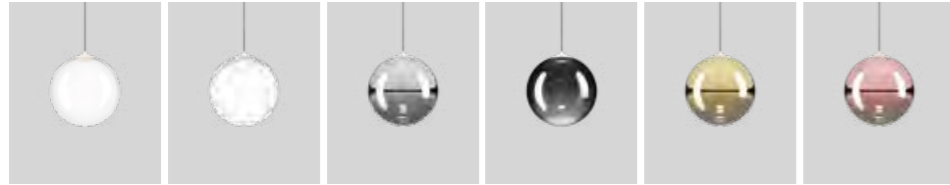

Random Solo 28 Cluster suspension lamp **NEW LAMP**



Finishes Gradient effect

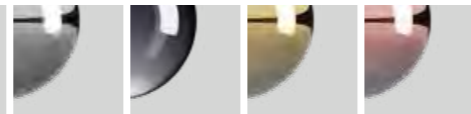

Random Solo, design by Chia-Ying Lee, 2020

Cluster suspension lamp

Random Solo 12 **NEW**

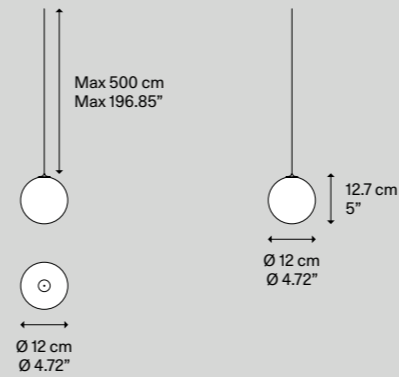

Light source
Sorgente luminosa

LED
↘ 2700 K
↘ 1 W/150 lm
↘ 350 mA
↘ CRI 90
↘ MacAdam 3-Step

LED and driver included
LED e driver inclusi

or

LED
↘ 3000 K
↘ 1 W/160 lm
↘ 350 mA
↘ CRI 90
↘ MacAdam 3-Step

LED and driver included
LED e driver inclusi

Blown glass diffuser
Diffusore in vetro soffiato

- Clear
Trasparente **171001**
- Frosted White
Bianco Satinato **171002**
- Chrome
Cromo **171003**
- Glossy Smoke
Fumo Lucido **171004**
- Gold
Oro **171005**
- Rose Gold
Oro Rosa **171006**
- Clear
Trasparente **171007**
- Frosted White
Bianco Satinato **171008**
- Chrome
Cromo **171009**
- Glossy Smoke
Fumo Lucido **171010**
- Gold
Oro **171011**
- Rose Gold
Oro Rosa **171012**

Net weight/Peso netto: 0.25 kg

Pack/Colli: 2

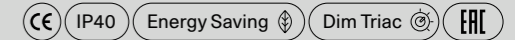

Random Solo 14 **NEW**

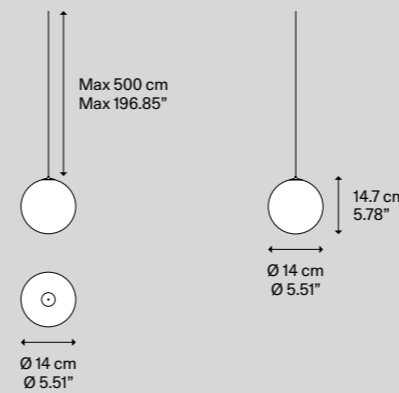

LED
↘ 2700 K
↘ 1 W/150 lm
↘ 350 mA
↘ CRI 90
↘ MacAdam 3-Step

LED and driver included
LED e driver inclusi

or

LED
↘ 3000 K
↘ 1 W/160 lm
↘ 350 mA
↘ CRI 90
↘ MacAdam 3-Step

LED and driver included
LED e driver inclusi

- Clear
Trasparente **171013**
- Frosted White
Bianco Satinato **171014**
- Chrome
Cromo **171015**
- Glossy Smoke
Fumo Lucido **171016**
- Gold
Oro **171017**
- Rose Gold
Oro Rosa **171018**
- Clear
Trasparente **171019**
- Frosted White
Bianco Satinato **171020**
- Chrome
Cromo **171021**
- Glossy Smoke
Fumo Lucido **171022**
- Gold
Oro **171023**
- Rose Gold
Oro Rosa **171024**

Net weight/Peso netto: 0.32 kg

Pack/Colli: 2

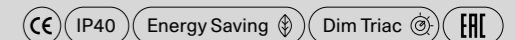

Random Solo, design by Chia-Ying Lee, 2020

Cluster suspension lamp

Random Solo 18 **NEW**

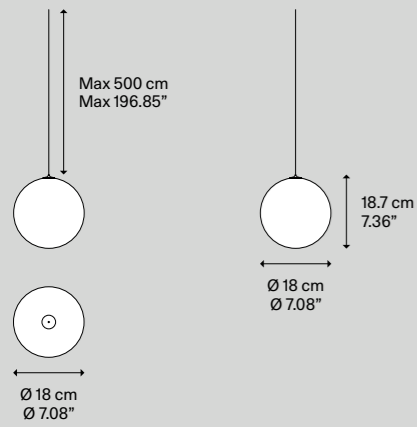

Light source Sorgente luminosa	Blown glass diffuser Diffusore in vetro soffiato	Code Codice
LED ↘ 2700 K ↘ 1 W / 150 lm ↘ 350 mA ↘ CRI 90 ↘ MacAdam 3-Step LED and driver included LED e driver inclusi	Clear Trasparente	171025
	Frosted White Bianco Satinato	171026
	Chrome Cromo	171027
	Glossy Smoke Fumo Lucido	171028
	Gold Oro	171029
	Rose Gold Oro Rosa	171030
	or	
	Clear Trasparente	171031
	Frosted White Bianco Satinato	171032
	Chrome Cromo	171033
LED ↘ 3000 K ↘ 1 W / 160 lm ↘ 350 mA ↘ CRI 90 ↘ MacAdam 3-Step LED and driver included LED e driver inclusi	Glossy Smoke Fumo Lucido	171034
	Gold Oro	171035
	Rose Gold Oro Rosa	171036

Net weight/Peso netto: 0.8 kg Pack/Colli: 2

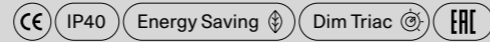

Random Solo 23 **NEW**

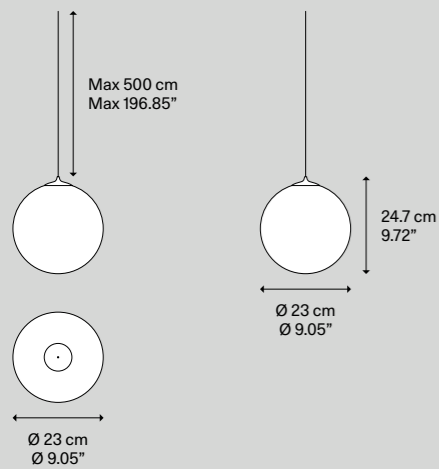

Light source Sorgente luminosa	Blown glass diffuser Diffusore in vetro soffiato	Code Codice
LED ↘ 2700 K ↘ 3 W / 450 lm ↘ 350 mA ↘ CRI 90 ↘ MacAdam 3-Step LED and driver included LED e driver inclusi	Clear Trasparente	171037
	Frosted White Bianco Satinato	171038
	Chrome Cromo	171039
	Glossy Smoke Fumo Lucido	171040
	Gold Oro	171041
	Rose Gold Oro Rosa	171042
	or	
	Clear Trasparente	171043
	Frosted White Bianco Satinato	171044
	Chrome Cromo	171045
LED ↘ 3000 K ↘ 3 W / 480 lm ↘ 350 mA ↘ CRI 90 ↘ MacAdam 3-Step LED and driver included LED e driver inclusi	Glossy Smoke Fumo Lucido	171046
	Gold Oro	171047
	Rose Gold Oro Rosa	171048

Net weight/Peso netto: 1.1 kg Pack/Colli: 2

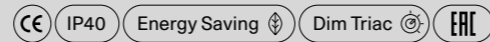

Random Solo, design by Chia-Ying Lee, 2020

Cluster suspension lamp

Random Solo 28 **NEW**

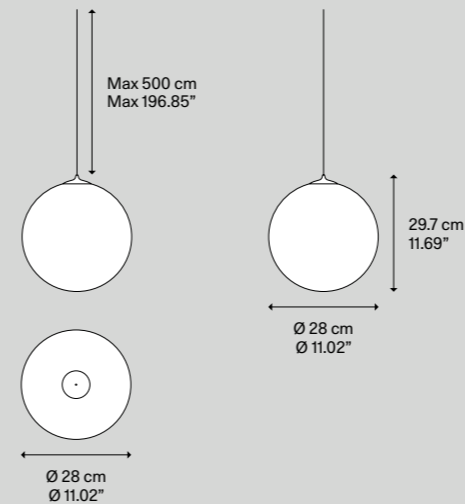

Light source Sorgente luminosa	Blown glass diffuser Diffusore in vetro soffiato	Code Codice
LED ↘ 2700 K ↘ 3 W / 450 lm ↘ 350 mA ↘ CRI 90 ↘ MacAdam 3-Step LED and driver included LED e driver inclusi	Clear Trasparente	171049
	Frosted White Bianco Satinato	171050
	Chrome Cromo	171051
	Glossy Smoke Fumo Lucido	171052
	Gold Oro	171053
	Rose Gold Oro Rosa	171054
	or	
	Clear Trasparente	171055
	Frosted White Bianco Satinato	171056
	Chrome Cromo	171057
LED ↘ 3000 K ↘ 3 W / 480 lm ↘ 350 mA ↘ CRI 90 ↘ MacAdam 3-Step LED and driver included LED e driver inclusi	Glossy Smoke Fumo Lucido	171058
	Gold Oro	171059
	Rose Gold Oro Rosa	171060

Net weight/Peso netto: 1.8 kg Pack/Colli: 2

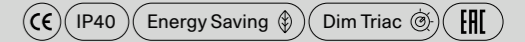

Suspension lamps must be installed on a canopy ▶ pag. 352-363
Le lampade a sospensione devono essere installate su rosone ▶ pag. 352-363

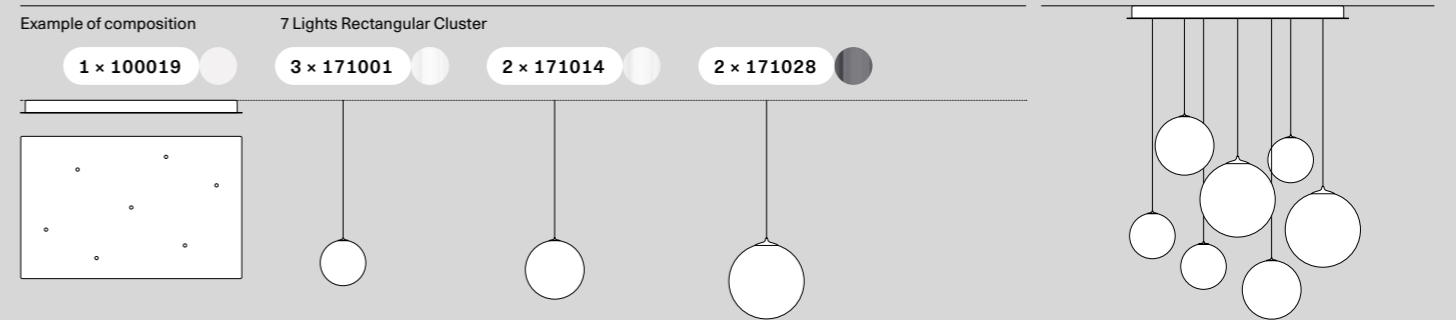

Random

A lightweight, blown glass suspension light, Random is made up of three round diffusers of different sizes which form one simple, eye-catching whole. Each diffuser has an LED light source which emits warm white light. When grouped together on a cluster, Random light fixtures form a poetic composition like soap bubbles, enhanced by the glossy coloured finishes which add a touch of character and originality.

Leggerissima lampada a sospensione in vetro soffiato, Random è composta da tre diffusori sferici di dimensioni diverse che formano un'entità semplice e vivace. Ogni diffusore è dotato di una sorgente luminosa a LED che fornisce una calda luce bianca. Raggruppate su cluster le lampade Random danno vita a composizioni poetiche come giochi di bolle di sapone, che le finiture lucide sfumate arricchiscono di carattere e originalità.

Cluster suspension lamp

Random,
FINISH Frosted White

Random, *design by Chia-Ying Lee, 2017*





Random,
Track System, composition of 7 lights,
FINISHES Glossy Smoke and Clear

Random,
FINISH Clear



Random, *Round Cluster System*,
composition of 5 lights, FINISH Clear



Random, *Recessed Micro Canopies*, FINISHES Clear, Gold and Frosted White



Random, *Rectangular Cluster System*,
composition of 14 lights, FINISH Rose Gold

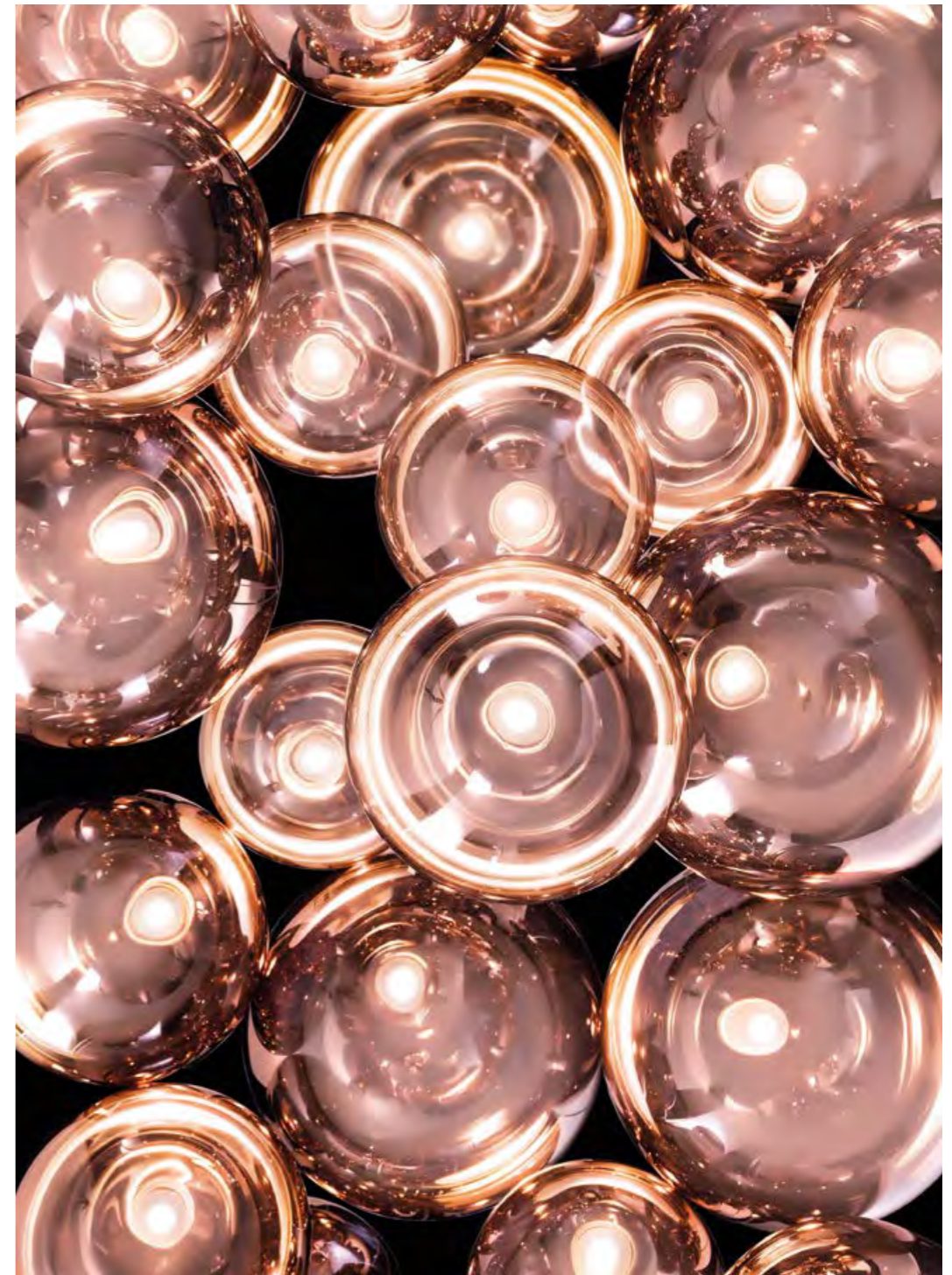

Random, FINISH Rose Gold



Random, *Round Cluster System*, composition of 36 lights, FINISH Clear



Random, *Round Cluster System*, composition of 36 lights, FINISHES Gold, Rose Gold and Chrome

Suspension très légère en verre soufflé, Random est composée de trois diffuseurs sphériques de différentes tailles formant une entité simple et vivante. Chaque diffuseur est équipé d'une source lumineuse LED qui fournit une lumière blanche chaude. Regroupées en cluster, les lampes Random donnent vie à des compositions poétiques telles que des jeux de bulles de savon, dont les finitions douces et ombragées enrichissent le caractère et l'originalité. ●FR

Random ist eine ultraleichte Hängeleuchte aus geblasenem Glas und besteht aus drei kugelförmigen Diffusoren in unterschiedlicher Größe, die eine einfache und lebhaft Einheit bilden. Jeder Diffusor verfügt über eine LED-Lichtquelle, die warmweißes Licht abstrahlt. In Clustern angeordnet, lassen die Leuchten Random poetische Kombinationen entstehen, die einem Spiel aus Seifenblasen ähneln und denen die glänzenden, nuancierten Ausführungen Charakter und Originalität verleihen. ●DE

Lámpara muy ligera colgante de vidrio soplado, Random está compuesta de tres difusores esféricos de diferentes dimensiones que forman una entidad simple y dinámica. Cada difusor está equipado con una fuente luminosa de LED que proporciona una luz blanca cálida. Reagrupadas en grupos de lámparas colgantes Random dan vida a composiciones poéticas como juegos de pompas de jabón, que los acabados brillantes matizados enriquecen con carácter y originalidad. ●ES

Random – это легкий подвесной светильник из выдувного стекла, состоящий из трех сферических диффузоров разных размеров, которые образуют простую и живую композицию. Каждый диффузор оснащен светодиодным источником теплого белого света. Объединенные в кластеры лампы Random дают жизнь восхитительным композициям, таким как игра мыльных пузырей, а гляцевая отделка придает им своеобразный характер и оригинальность. ●RU

Random是一款非常轻盈的吹制玻璃吊灯，由三个不同尺寸的球形灯罩组成，形成简单活泼的整体。每一个灯罩都配有一个LED光源，提供白色的温暖灯光。集中在组合吊上，Random灯可形成诗意的组合，如同肥皂泡的嬉戏，光亮的色泽丰富了个性与原创性。●ZH

Random » Cluster suspension lamp



Finishes » Gradient effect

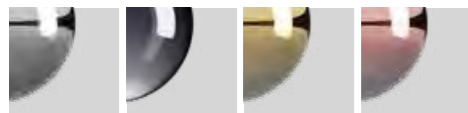

Random, design by Chia-Ying Lee, 2017

Cluster suspension lamp

Random

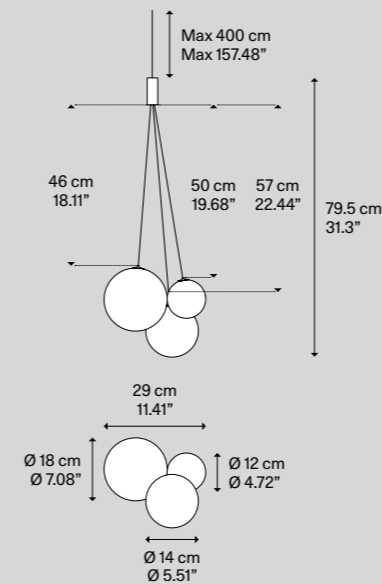

Light source Sorgente luminosa

LED
» 2700 K
» 3 × 1 W / 450 lm
» 350 mA
» CRI 90
» MacAdam 3-Step

LED and driver included
LED e driver inclusi

or

LED
» 3000 K
» 3 × 1 W / 480 lm
» 350 mA
» CRI 90
» MacAdam 3-Step

LED and driver included
LED e driver inclusi

Metal structure Montatura in metallo

Chrome
Cromo

Chrome
Cromo

Blown glass diffuser Diffusore in vetro soffiato

Clear
Trasparente

Chrome
Cromo

Gold
Oro

Rose Gold
Oro Rosa

Glossy Smoke
Fumo Lucido

Frosted White ^{NEW}
Bianco Satinato

Clear
Trasparente

Chrome
Cromo

Gold
Oro

Rose Gold
Oro Rosa

Glossy Smoke
Fumo Lucido

Frosted White ^{NEW}
Bianco Satinato

Code Codice

164001

164002

164003

164004

164005

164006

164007

164008

164010

164011

164009

164012

Net weight/Peso netto: 1.0 kg

Pack/Colli: 2

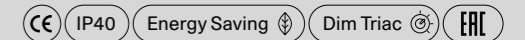

Suspension lamps must be installed on a canopy » pag. 352–363
Le lampade a sospensione devono essere installate su rosone » pag. 352–363

Example of composition

3 Lights Round Cluster

1 × 100014 1 × 164006 1 × 164002 1 × 164004

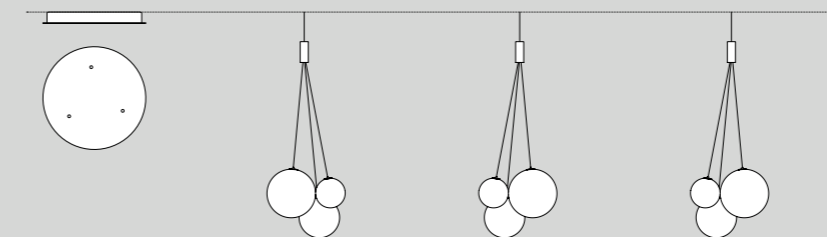

Example of composition

4 Lights Radial Cluster and Swag Kit for Radial Canopy

1 × 100041 4 × 130109 2 × 164003 2 × 164004

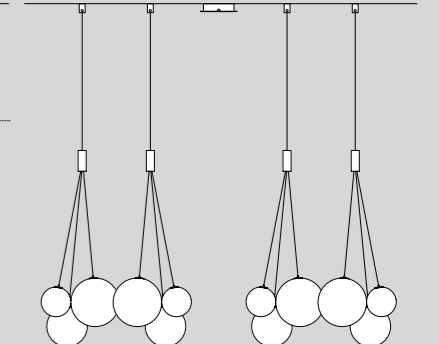
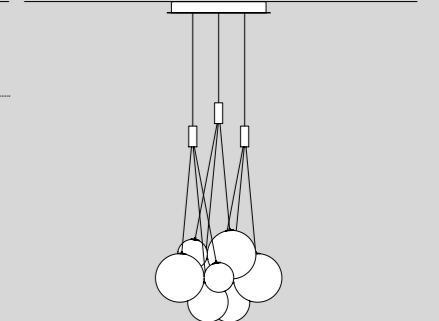
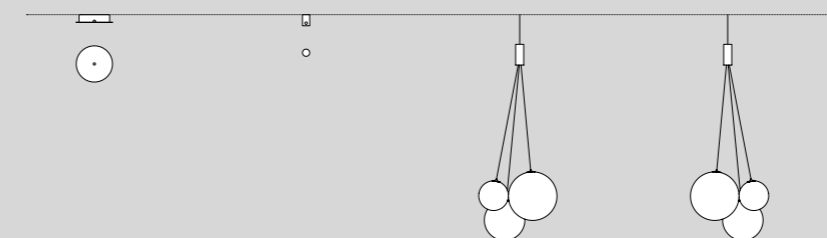

Nostalgia

With its retro flair, Nostalgia elegantly tells of ancient glass blowing practices in three sinuous forms that can be combined at will. The perfection of the glass, the innovative LED technology and six elegant finishes make Nostalgia an extremely modern and versatile lamp that lends itself to the creation of captivating atmospheres, whether on or off.

Con il suo sapore retrò, Nostalgia racconta con eleganza antiche storie di vetro soffiato in tre forme sinuose che possono essere combinate a piacere. La perfezione del vetro, l'innovativa tecnologia LED e le sei raffinate finiture fanno di Nostalgia una lampada estremamente contemporanea e versatile che permette di creare atmosfere affascinanti sia da accesa che da spenta.

Cluster suspension lamp

Nostalgia medium, large and small,
FINISH Glossy Bronze

Nostalgia, *design by* Dima Loginoff, 2015





Nostalgia small, medium and large, *Rectangular Cluster System*, composition of 14 lights

FINISHES Clear, Glossy Bronze and Glossy Smoke



Nostalgia medium, small and large,
FINISH Clear



Nostalgia medium,
FINISHES Clear, Chrome, Gold and Rose Gold



Nostalgia small, medium and large, special composition of 82 lights, FINISHES Clear, Chrome and Gold



Nostalgia large, FINISH Clear

Nostalgia small, medium and large,
Track System, composition of 5 lights,
FINISH Clear





Nostalgia large, *Round Cluster System*, composition of 7 lights, FINISH Rose Gold



Nostalgia small, medium and large, *Round Cluster System*, composition of 36 lights, FINISH Rose Gold



Nostalgia small, FINISH Clear

Avec son charme rétro, Nostalgia raconte avec élégance d'anciennes histoires de verre soufflé en trois formes sinueuses qui peuvent être combinées à souhait. La perfection du verre, l'innovante technologie LED et ses finitions raffinées font de Nostalgia une lampe très contemporaine et polyvalente qui permet de créer une atmosphère fascinante qu'elle soit éclairée ou éteinte. ● FR

Mit ihrem Retro-Stil erzählt Nostalgia mit Eleganz alte Geschichten von mundgeblasenem Glas in drei geschwungenen Formen, die nach Belieben kombiniert werden können. Die Perfektion des Glases, die innovative LED-Technologie und die sechs raffinierten Ausführungen machen aus Nostalgia eine besonders moderne und vielseitige Lampe, die sowohl ein- wie auch ausgeschaltet faszinierende Atmosphären schafft. ● DE

Con su sabor retro, Nostalgia cuenta con elegancia antiguas historias de vidrio soplado en tres formas sinuosas que pueden combinarse a voluntad. La perfección del vidrio, la innovadora tecnología LED y los seis refinados acabados hacen de Nostalgia una lámpara extremadamente contemporánea y versátil que permite crear fascinantes atmósferas tanto encendida como apagada. ● ES

Выполненный в стиле ретро, светильник Nostalgia изящно повествует о древней истории выдувного стекла, представая в трех изогнутых объемных формах, которые можно комбинировать по собственному вкусу. Совершенство стекла, инновационная технология LED и шесть вариантов изысканной отделки делают светильник Nostalgia необыкновенно современным и универсальным, позволяющим создавать чарующую атмосферу как во включенном, так и в выключенном виде. ● RU

Nostalgia具有复古气息，优雅地讲述了吹制玻璃的三种古老形状，可以任意组合。玻璃的完美表现，创新的LED技术和六种精致的颜色，使Nostalgia成为一款极为现代且用途广泛的灯具，可让您在开与关之间营造出迷人的氛围。● ZH

Nostalgia small ▾ Cluster suspension lamp



Nostalgia medium ▾ Cluster suspension lamp



Nostalgia large ▾ Cluster suspension lamp



Nostalgia, design by Dima Loginoff, 2015

Cluster suspension lamp

Nostalgia small

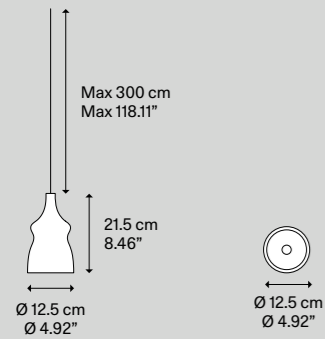

Light source
Sorgente luminosa

LED
↘ 2700 K
↘ 9 W / 920 lm
↘ 220-240 V
↘ CRI 92
↘ MacAdam 3-Step

LED included
LED incluso

Metal structure
Montatura in metallo

Chrome
Cromo

Blown glass diffuser
Diffusore in vetro soffiato

Clear
Trasparente

Chrome
Cromo

Gold
Oro

Rose Gold
Oro Rosa

Glossy Smoke
Fumo Lucido

Glossy Bronze
Bronzo Lucido

Code
Codice

154001

154002

154003

154004

154051

154050

Net weight / Peso netto: 0.66 kg

Pack / Colli: 2

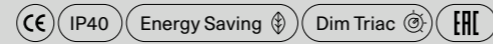

Nostalgia medium

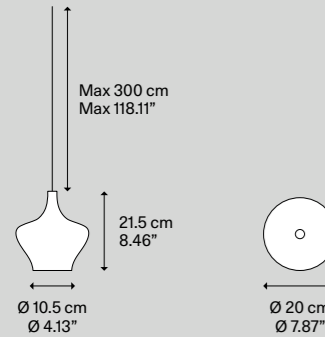

LED
↘ 2700 K
↘ 9 W / 920 lm
↘ 220-240 V
↘ CRI 92
↘ MacAdam 3-Step

LED included
LED incluso

Chrome
Cromo

Clear
Trasparente

Chrome
Cromo

Gold
Oro

Rose Gold
Oro Rosa

Glossy Smoke
Fumo Lucido

Glossy Bronze
Bronzo Lucido

154005

154006

154007

154008

154053

154052

Net weight / Peso netto: 0.75 kg

Pack / Colli: 2

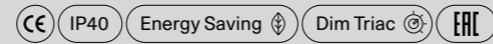

Nostalgia large

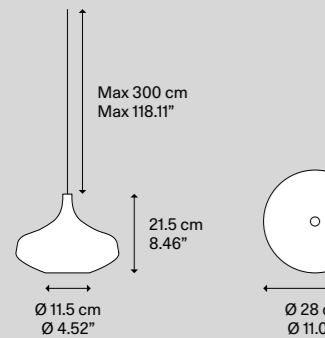

LED
↘ 2700 K
↘ 9 W / 920 lm
↘ 220-240 V
↘ CRI 92
↘ MacAdam 3-Step

LED included
LED incluso

Chrome
Cromo

Clear
Trasparente

Chrome
Cromo

Gold
Oro

Rose Gold
Oro Rosa

Glossy Smoke
Fumo Lucido

Glossy Bronze
Bronzo Lucido

154009

154010

154011

154012

154055

154054

Net weight / Peso netto: 1.02 kg

Pack / Colli: 2

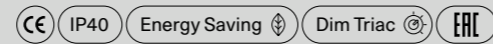

Suspension lamps must be installed on a canopy ▶ pag. 352-363
Le lampade a sospensione devono essere installate su rosone ▶ pag. 352-363

Nostalgia, design by Dima Loginoff, 2015

Example of composition

7 Lights Rectangular Cluster

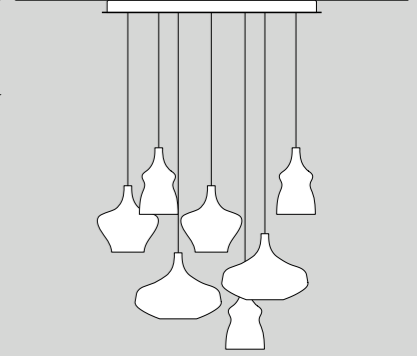
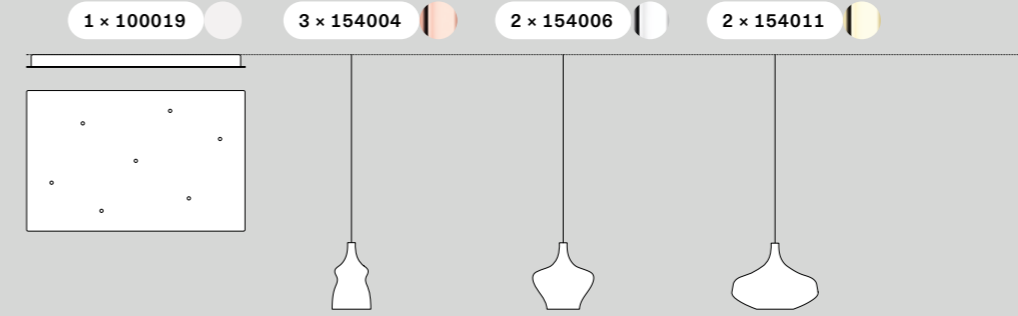

Example of composition

14 Lights Round Cluster

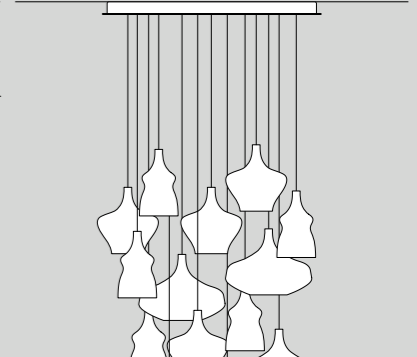
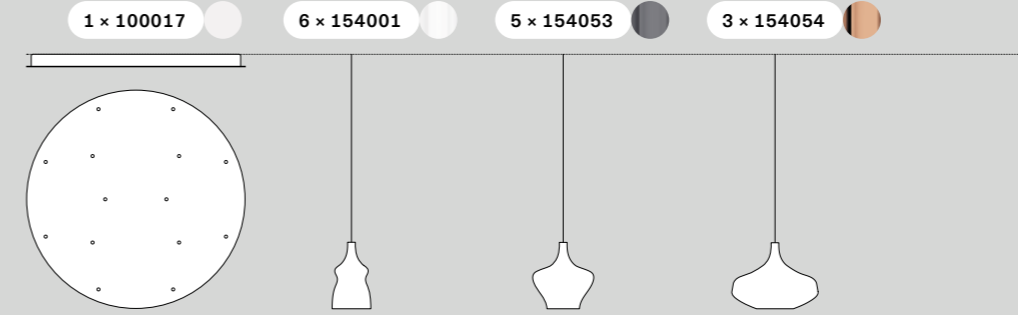

Example of composition

Short Lights Track

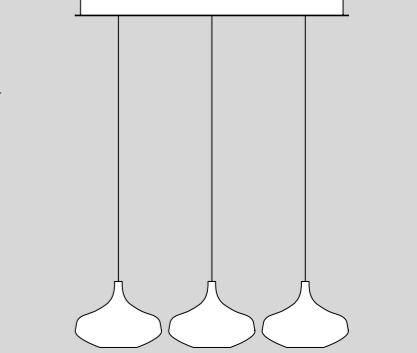
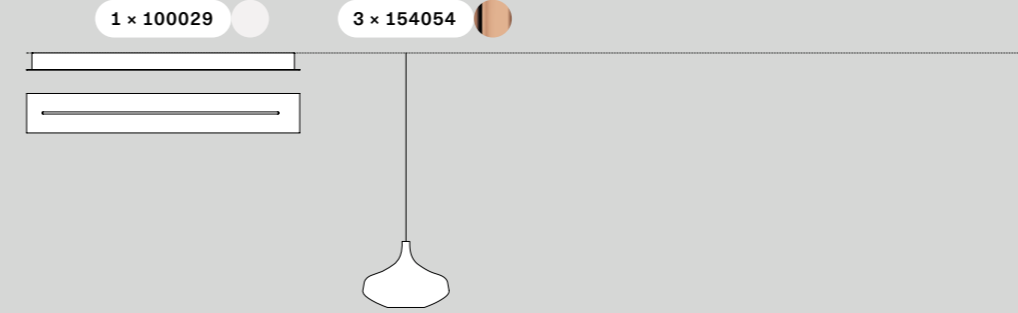

LED module with direct power supply to the AC line voltage - driver not required. Dimmable with phase cut dimmer.

LED con alimentazione diretta a tensione di rete - non necessita di driver. Dimmerabile con varialuce a taglio di fase.

Jefferson

The Jefferson suspension lamp designed by Luca Nichetto is reminiscent of music and iconic images in psychedelic works of art from the 1960s. The vortex motif decorating the diffuser is embellished by the timeless classicism of Bohemian crystal, which diffuses evocative atmospheres of light. Dynamic in its many sizes and multiple compositions, Jefferson's elegance keeps up with the excellent performance of LED interior lighting.

La lampada a sospensione Jefferson disegnata da Luca Nichetto rimanda alla musica e alle immagini iconiche in opere d'arte psichedeliche degli anni Sessanta. Il motivo a vortice che decora il diffusore è impreziosito dalla classicità senza tempo del cristallo di Boemia, che diffonde suggestive atmosfere di luce. Dinamica nelle diverse dimensioni e in composizioni multiple, l'eleganza di Jefferson non rinuncia alle eccellenti prestazioni della luce interna a LED.

Cluster suspension lamp

Jefferson small, medium and mini,
FINISH Clear + Gold

Jefferson, *design by* Luca Nichetto, 2019





Jefferson mini, small and medium,
FINISH Clear + Gold

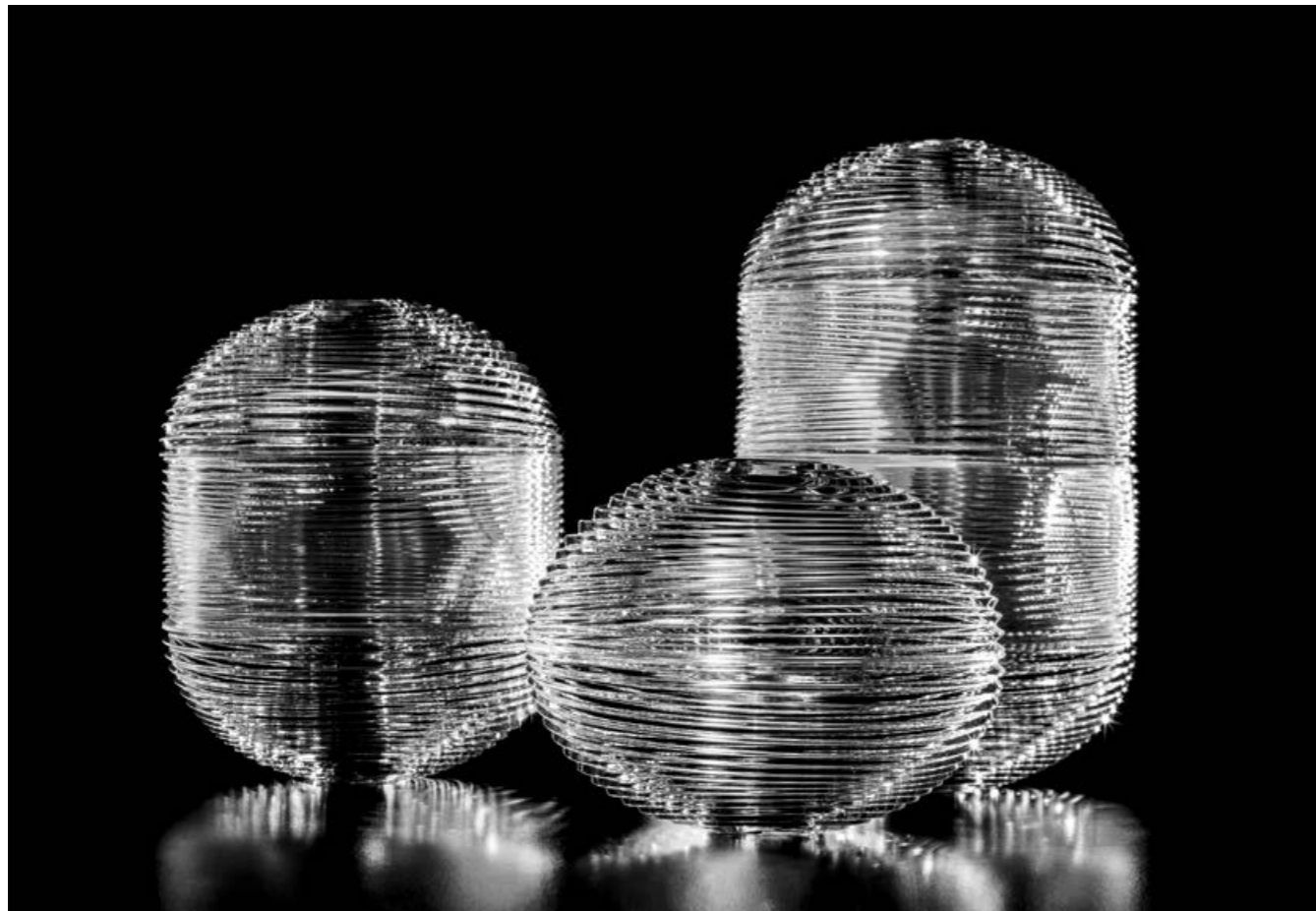

Jefferson small, mini and medium

Jefferson mini, small and medium,
Round Cluster System, composition of 5 lights,
FINISH Clear + Gold



Jefferson mini, small and medium,
Rectangular Cluster System, composition of 28 lights,
FINISH Clear + Black Chrome



Jefferson mini, small and medium,
Round Cluster System, composition of 36 lights,
FINISH Clear + Black Chrome

Jefferson mini, *Round Cluster System*, composition of 36 lights,
FINISH Clear + Black Chrome

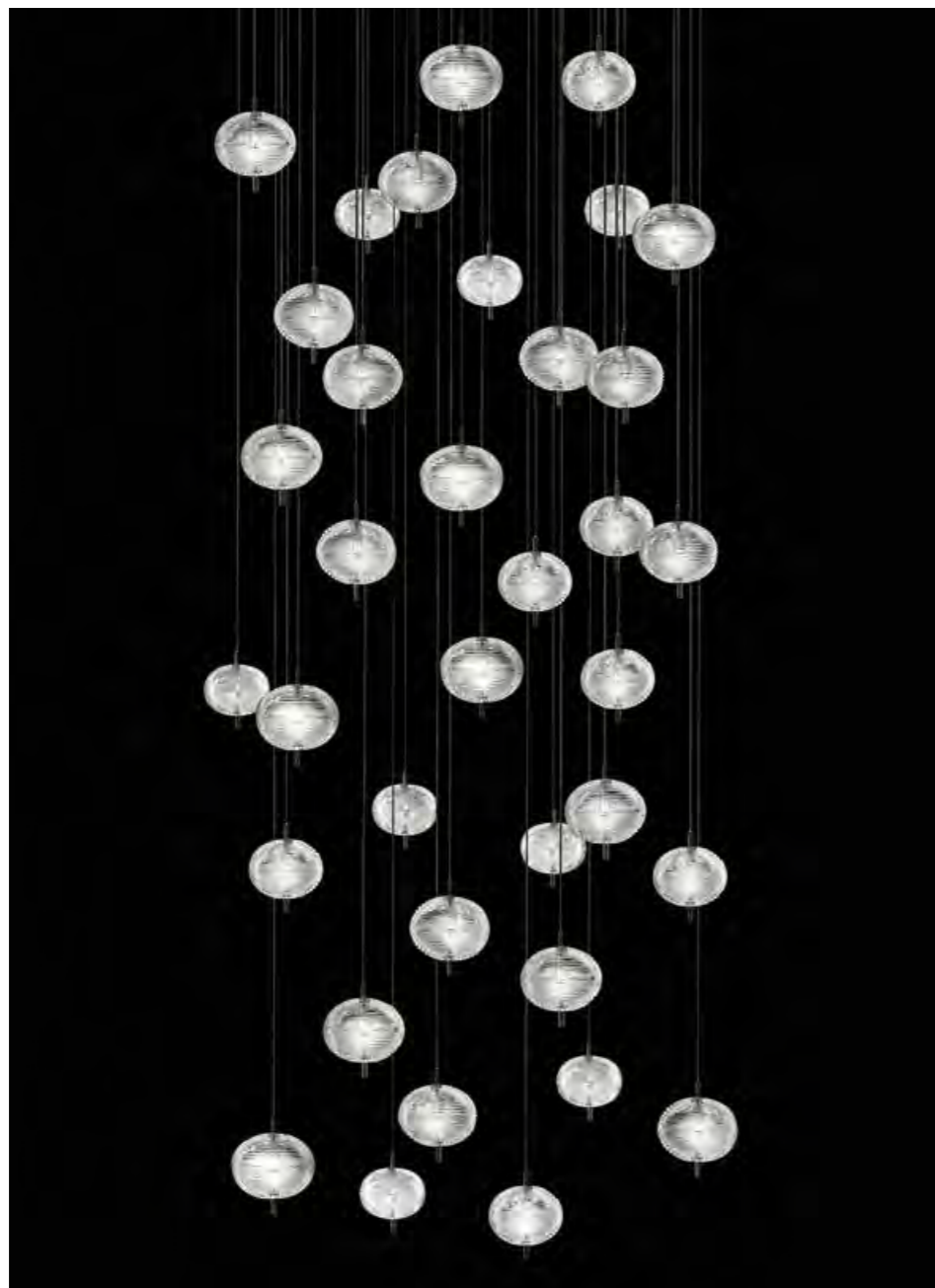

La lampe à suspension Jefferson dessinée par Luca Nichetto fait référence à la musique et aux images emblématiques des œuvres d'art psychédélics des années soixante. Le motif vortex qui orne le diffuseur est rehaussé par le classicisme intemporel du cristal de Bohême, qui diffuse des atmosphères de lumière suggestives. Dynamique dans différentes tailles et dans de multiples compositions, l'élégance de Jefferson ne renonce pas aux excellentes performances de l'éclairage intérieur LED. ● FR

Die von Luca Nichetto entworfene Hängeleuchte „Jefferson“ erinnert an die Musik und die ikonischen Darstellungen in psychedelischen Kunstwerken der sechziger Jahre. Die Wirbel-Optik des Diffusors wird aufgewertet durch den klassisch-zeitlosen Stil des böhmischen Kristalls, das suggestive Lichtstimmungen erzeugt. Erhältlich in verschiedenen Größen und vielfältigen Kompositionen, verzichtet die Eleganz von Jefferson nicht auf die hervorragende Leistung der LED-Innenbeleuchtung. ● DE

La lámpara colgante Jefferson diseñada por Luca Nichetto hace referencia a la música y a las imágenes icónicas en obras de arte psicodélicas de los años sesenta. El motivo en espiral que decora el difusor está embellecido por el estilo clásico sin tiempo del cristal de Bohemia, que difunde atmósferas sugestivas de luz. Dinámica en los diferentes tamaños y en composiciones múltiples, la elegancia de Jefferson no renuncia a las excelentes prestaciones de la luz interna de LED. ● ES

Подвесной светильник Jefferson, дизайн Лука Никетто, вызывает в памяти музыку и культовые изображения на психоделических произведениях шестидесятых годов. Ценность вихревому украшению диффузора придает вечная классика богемского хрустала, благодаря которому создается необыкновенная световая атмосфера. Элегантная и динамичная за счет различных размеров и множественных комбинаций модель Jefferson не отказывается от превосходных характеристик внутреннего светодиодного освещения. ● RU

Luca Nichetto受上世纪六十年代迷幻视觉艺术的音乐和图案的启发设计了吊灯Jefferson。灯罩上装饰的漩涡图案因波西米亚水晶的永恒古典主义更显精美珍贵，将迷人的光线散发开来。Jefferson吊灯具有不同尺寸和多种组成的动态变化，精美雅致的同时更良好利用了内置LED灯的出色性能。● ZH

Jefferson mini » Cluster suspension lamp



Jefferson small » Cluster suspension lamp

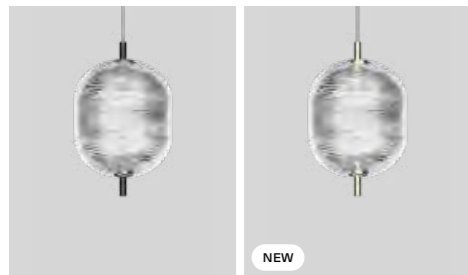

Jefferson medium » Cluster suspension lamp



Jefferson, design by Luca Nichetto, 2019

Cluster suspension lamp

Jefferson mini

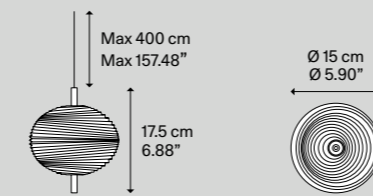

Net weight/Peso netto: 1.40 kg

Pack/Colli: 1

Light source
Sorgente luminosa

LED
 » 2700 K
 » 3 W/450 lm
 » 350 mA
 » CRI 90
 » MacAdam 3-Step

LED and driver included
 LED e driver inclusi

Metal structure
Montatura in metallo

● Black Chrome
Cromo Nero

● Gold NEW
Oro

Bohemian crystal diffuser
Diffusore in cristallo di Boemia

● Clear
Trasparente

● Clear
Trasparente

Code
Codice

168101

168104

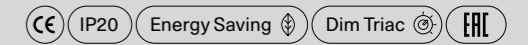

Jefferson small

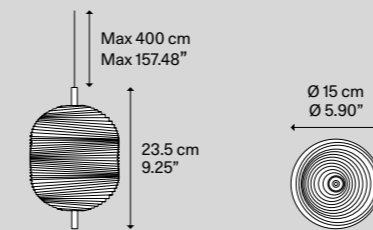

Net weight/Peso netto: 2.10 kg

Pack/Colli: 1

Light source
Sorgente luminosa

LED
 » 2700 K
 » 3 W/450 lm
 » 350 mA
 » CRI 90
 » MacAdam 3-Step

LED and driver included
 LED e driver inclusi

● Black Chrome
Cromo Nero

● Gold NEW
Oro

● Clear
Trasparente

● Clear
Trasparente

168102

168105

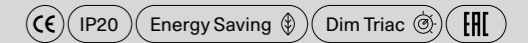

Jefferson medium

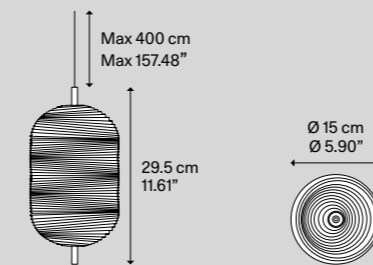

Net weight/Peso netto: 2.80 kg

Pack/Colli: 1

Light source
Sorgente luminosa

LED
 » 2700 K
 » 3 W/450 lm
 » 350 mA
 » CRI 90
 » MacAdam 3-Step

LED and driver included
 LED e driver inclusi

● Black Chrome
Cromo Nero

● Gold NEW
Oro

● Clear
Trasparente

● Clear
Trasparente

168103

168106

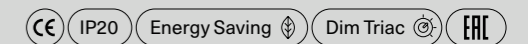

Suspension lamps must be installed on a canopy » pag. 352-363
 Le lampade a sospensione devono essere installate su rosone » pag. 352-363

Example of composition

3 Lights Round Cluster

1 x 100014 1 x 168104 1 x 168105 1 x 168106

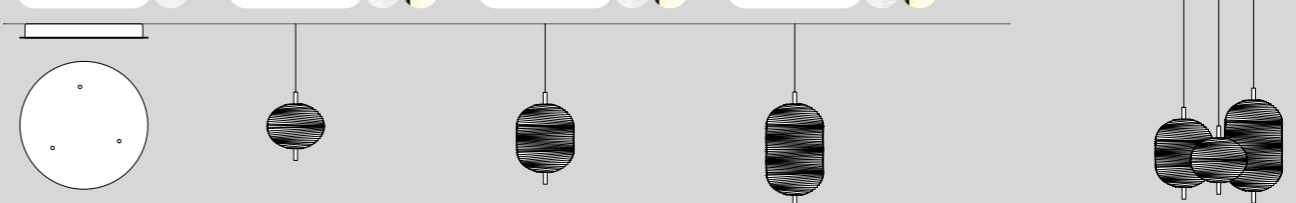

JIM

Immediate function, uncomplicated style, durable materials, modular at will. Inspired by the abat-jours of the ateliers of the early 1900s, JIM is a system of suspension lamps with distinctive shapes and a versatile composition that suits any interiors and living environment. JIM's versatility is further enhanced by the colour range: the four different finishes for the shades can be combined with the three different suspension hook hues as desired.

Immediatezza di funzione, semplicità delle linee, materiali durevoli, componibilità a piacere. Ispirato ai paralumi degli atelier di artisti dell'inizio del 1900, JIM è un sistema di lampade a sospensione dalle forme distintive e dalla composizione versatile che si adatta a qualsiasi interno e ambiente abitativo. La versatilità di JIM è ulteriormente valorizzata dalla gamma cromatica: le quattro diverse finiture disponibili per i paralumi possono essere combinate a piacere con le tre diverse tonalità del gancio a cui è sospesa la lampada.

Cluster suspension lamp, Suspension lamp

JIM cylinder, cone and bell,
FINISH Coppery Bronze

JIM, *design by* Patrick Norguet, 2021





JIM bell, FINISH Matte Champagne

JIM cylinder, cone and bell, *Rectangular Cluster System*,
composition of 14 lights, FINISH Matte Black



JIM bell, cylinder and cone, FINISHES Matte White, Matte Champagne and Matte Black

JIM cylinder, cone and bell, *Round Cluster System*, composition of 36 lights, FINISHES Matte Black and Matte Champagne





JIM cylinder, cone and bell,
Single Mini Canopies, FINISH Matte White



JIM dome, FINISH Matte White



JIM dome, FINISH Matte Black



JIM dome,
FINISH Coppery Bronze



JIM dome,
FINISH Matte Champagne

Immédiateté de fonction, simplicité des lignes, matériaux durables, modularité en fonction des goûts personnels. S'inspirant des abat-jours des ateliers d'artistes du début du XXe siècle, JIM est un système de lampes à suspension arborant des formes distinctives et une composition polyvalente qui s'adapte à tous les styles d'habitation. La gamme chromatique souligne encore plus la polyvalence de JIM : les quatre différentes finitions disponibles pour les diffuseurs peuvent s'assortir, au choix, aux trois différentes tonalités du crochet de soutien. ● FR

Unmittelbarkeit der Funktion, Einfachheit der Linien, haltbare Materialien, Modularität nach Belieben. Inspiriert an den Lampenschirmen der Künstlerateliers der frühen 1900er Jahre, ist JIM ein Hängeleuchtsystem mit unverwechselbaren Formen und vielseitiger Gestaltungsmöglichkeit, das sich an jedes Interieur und jede Wohnumgebung anpasst. Die Vielseitigkeit von JIM wird durch die Farbpalette noch verstärkt: Die vier verschiedenen erhältlichen Ausführungen der Lampenschirme können beliebig mit den drei verschiedenen Farbtönen des Hakens, an dem die Leuchte aufgehängt wird, kombiniert werden. ● DE

Inmediatez de función, líneas sencillas, materiales duraderos y modularidad sin límites. Inspirado en las pantallas de los ateliers de artistas de principios del siglo XX, JIM es un sistema de lámparas colgantes con formas características y composición versátil que se adapta a cualquier interior y ambiente. La versatilidad de JIM la valoriza aún más la gama cromática: los cuatro acabados distintos disponibles para las pantallas se pueden combinar sin límites con los tres tonos del gancho en el que se cuelga la lámpara. ● ES

Улучшенная функциональность, простота линий, прочные материалы, модульная композиция. JIM представляет собой систему подвесных светильников, созданную в стиле абажуров ателье художников начала 1900-х годов, отличающуюся характерными формами и универсальной композицией, легко адаптирующуюся к любому интерьеру и жилищу. Универсальность применения системы JIM дополнительно повышена за счет хроматического диапазона: четыре варианта отделки абажуров комбинируются по желанию с тремя разными тональностями крюка, на котором подвешена лампа. ● RU

组拼随意的模块化与功能及时、线条简约和材料坚实之特性相邂逅。灵感源于二十世纪初期艺术家工坊中的灯罩，JIM是一种形状独特且组合多样的悬吊灯系统，适用于任何室内装饰与家居环境。色调范围之广，使JIM的通用性越发增值：灯罩的四种不同饰面可按喜好与悬灯钩的三种不同色调相搭配。● ZH

Grey hook
Gancio Grigio

Honey hook
Gancio Miele

Turquoise hook
Gancio Turchese

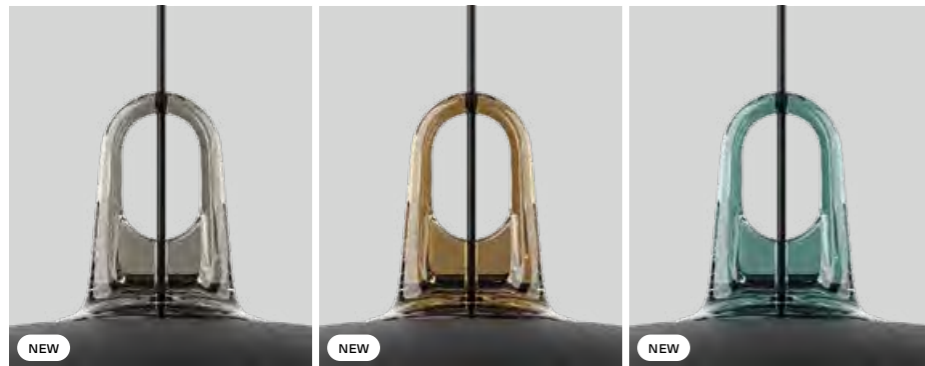

JIM dome ↘ Suspension lamp **NEW LAMP**

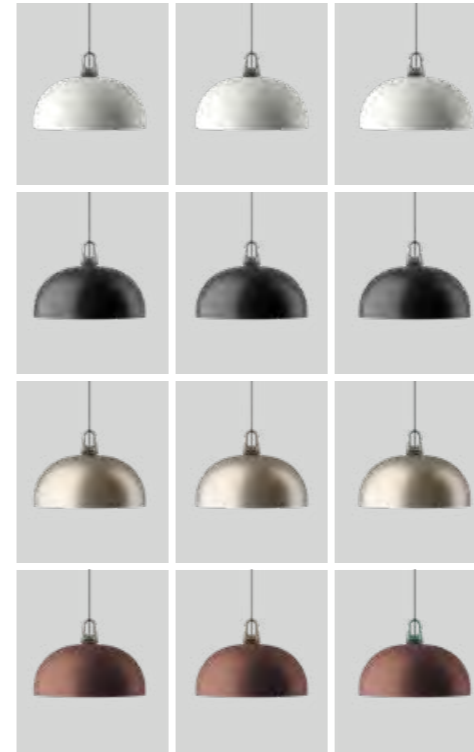

JIM cone ↘ Cluster suspension lamp **NEW LAMP**

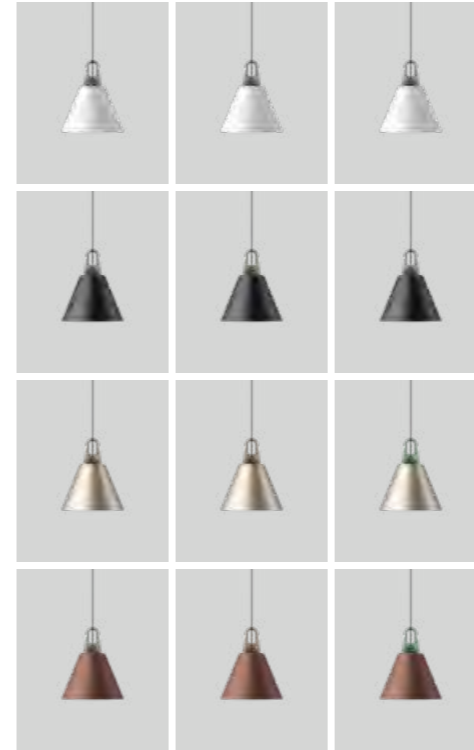

JIM cylinder ↘ Cluster suspension lamp **NEW LAMP**



JIM bell ↘ Cluster suspension lamp **NEW LAMP**

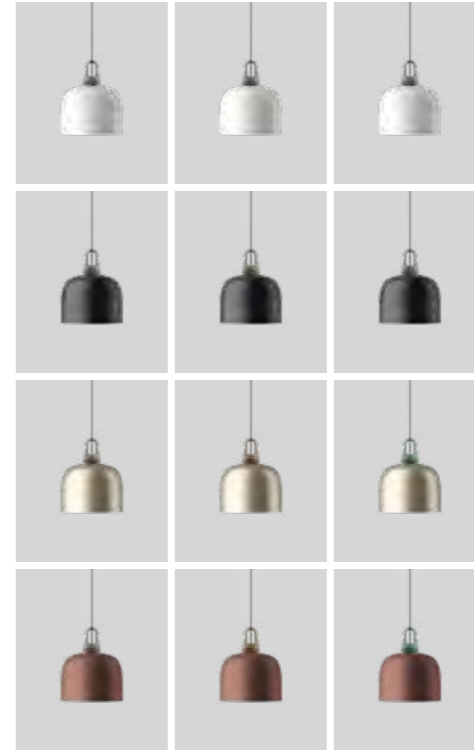

JIM, design by Patrick Norguet, 2021

Suspension lamp

JIM dome NEW

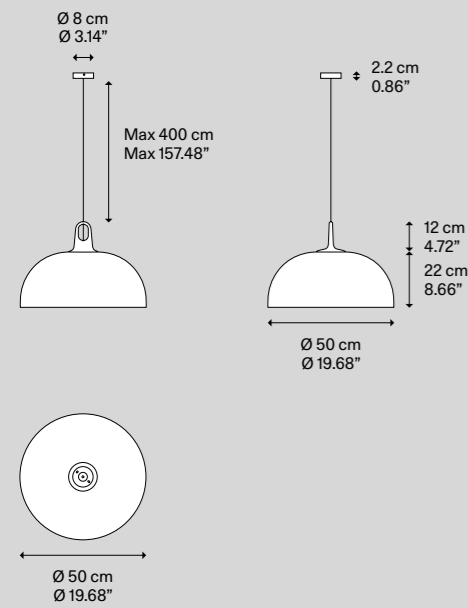

E27 A60 LED
1 x 25 W

Bulb not included
Lampadina non inclusa

Light source Sorgente luminosa	Outside metal diffuser Diff. esterno in metallo	Inside metal diffuser Diff. interno in metallo	Hook methacrylate Gancio in metacrilato	Code Codice
	Matte White-9010 Bianco Opaco-9010	Matte White-9010 Bianco Opaco-9010	Grey NEW Grigio	169052
			Honey NEW Miele	169047
			Turquoise NEW Turchese	169057
			Grey NEW Grigio	169054
	Matte Black-9005 Nero Opaco-9005	Matte White-9010 Bianco Opaco-9010	Honey NEW Miele	169049
			Turquoise NEW Turchese	169059
			Grey NEW Grigio	169053
	Matte Champagne Champagne Opaco	Matte White-9010 Bianco Opaco-9010	Honey NEW Miele	169048
			Turquoise NEW Turchese	169058
			Grey NEW Grigio	169051
	Coppery Bronze Bronzo Ramato	Matte White-9010 Bianco Opaco-9010	Honey NEW Miele	169046
			Turquoise NEW Turchese	169056

Net weight/Peso netto: 2.2 kg

Pack/Colli: 2

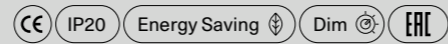

JIM, design by Patrick Norguet, 2021

Cluster suspension lamp

JIM cylinder NEW

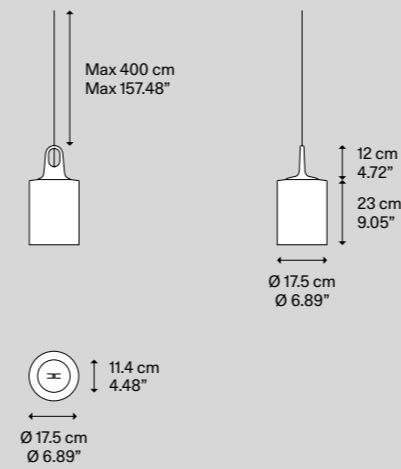

E27 A60 LED
1 x 25 W

Bulb not included
Lampadina non inclusa

Light source Sorgente luminosa	Outside metal diffuser Diff. esterno in metallo	Inside metal diffuser Diff. interno in metallo	Hook methacrylate Gancio in metacrilato	Code Codice
	Matte White-9010 Bianco Opaco-9010	Matte White-9010 Bianco Opaco-9010	Grey NEW Grigio	169022
			Honey NEW Miele	169017
			Turquoise NEW Turchese	169027
			Grey NEW Grigio	169024
	Matte Black-9005 Nero Opaco-9005	Matte White-9010 Bianco Opaco-9010	Honey NEW Miele	169019
			Turquoise NEW Turchese	169029
			Grey NEW Grigio	169023
	Matte Champagne Champagne Opaco	Matte White-9010 Bianco Opaco-9010	Honey NEW Miele	169018
			Turquoise NEW Turchese	169028
			Grey NEW Grigio	169021
	Coppery Bronze Bronzo Ramato	Matte White-9010 Bianco Opaco-9010	Honey NEW Miele	169016
			Turquoise NEW Turchese	169026

Net weight/Peso netto: 1.4 kg

Pack/Colli: 2

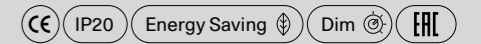

Suspension lamps must be installed on a canopy ► pag. 352-363
Le lampade a sospensione devono essere installate su rosone ► pag. 352-363

Cluster suspension lamp

JIM cone NEW

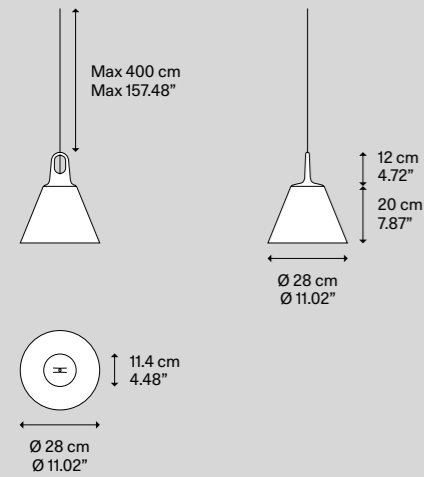

Light source Sorgente luminosa	Outside metal diffuser Diff. esterno in metallo	Inside metal diffuser Diff. interno in metallo	Hook methacrylate Gancio in metacrilato	Code Codice
E27 A60 LED 1 x 25 W	Matte White-9010 Bianco Opaco-9010	Matte White-9010 Bianco Opaco-9010	Grey NEW Grigio	169007
			Honey NEW Miele	169002
			Turquoise NEW Turchese	169012
			Grey NEW Grigio	169009
			Honey NEW Miele	169004
			Turquoise NEW Turchese	169014
	Matte Black-9005 Nero Opaco-9005	Matte White-9010 Bianco Opaco-9010	Grey NEW Grigio	169008
			Honey NEW Miele	169003
			Turquoise NEW Turchese	169013
			Grey NEW Grigio	169006
			Honey NEW Miele	169001
			Turquoise NEW Turchese	169011

Bulb not included
Lampadina non inclusa

Net weight/Peso netto: 1 kg Pack/Colli: 2

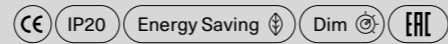

Suspension lamps must be installed on a canopy ▶ pag. 352-363
Le lampade a sospensione devono essere installate su rosone ▶ pag. 352-363

Cluster suspension lamp

JIM bell NEW

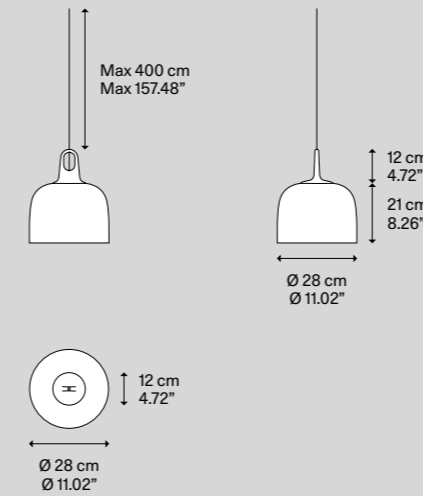

Light source Sorgente luminosa	Outside metal diffuser Diff. esterno in metallo	Inside metal diffuser Diff. interno in metallo	Hook methacrylate Gancio in metacrilato	Code Codice
E27 A60 LED 1 x 25 W	Matte White-9010 Bianco Opaco-9010	Matte White-9010 Bianco Opaco-9010	Grey NEW Grigio	169037
			Honey NEW Miele	169032
			Turquoise NEW Turchese	169042
			Grey NEW Grigio	169039
			Honey NEW Miele	169034
			Turquoise NEW Turchese	169044
	Matte Black-9005 Nero Opaco-9005	Matte White-9010 Bianco Opaco-9010	Grey NEW Grigio	169038
			Honey NEW Miele	169033
			Turquoise NEW Turchese	169043
			Grey NEW Grigio	169036
			Honey NEW Miele	169031
			Turquoise NEW Turchese	169041

Bulb not included
Lampadina non inclusa

Net weight/Peso netto: 1.9 kg Pack/Colli: 2

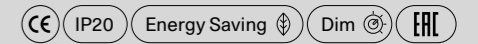

Suspension lamps must be installed on a canopy ▶ pag. 352-363
Le lampade a sospensione devono essere installate su rosone ▶ pag. 352-363

Example of composition

14 Lights Round Cluster

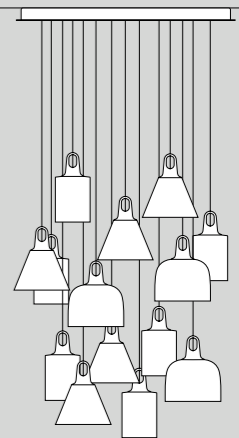
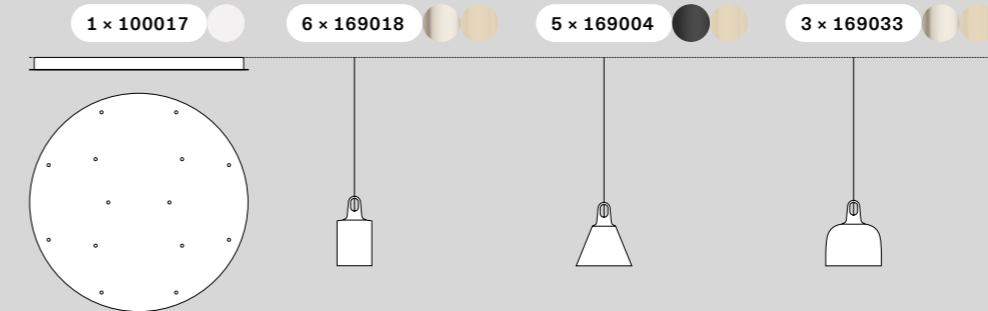

Kelly Cluster

Kelly Cluster spectacularly reinterprets the creative intuition of the family of Kelly lights in a sculptural and extremely compact sphere, mounted on a canopy and allowing multiple different compositions at will. A suspension lamp in metal, characterised by its lightness and vibrancy thanks to the unique laser cuts that create captivating plays of light and shadow, it is available in four different finishes bringing any space to life.

Kelly Cluster riformula brillantemente l'intuizione creativa della famiglia di lampade Kelly in una sfera sculturale ed estremamente compatta che, montata su rosone, permette di realizzare composizioni multiple a piacere. Lampada a sospensione in metallo, leggera e vivace grazie ai particolari tagli a laser che creano affascinanti giochi di luci e ombre, è disponibile in quattro diverse finiture in grado di far risaltare qualsiasi ambiente.

Cluster suspension lamp

Kelly Cluster, FINISHES Coppery Bronze,
Matte Black and Matte Champagne

Kelly Cluster, *design by* Andrea Toso, 2015





Kelly Cluster,
Round Cluster System, composition of 14 lights,
FINISHES Matte Black and Matte Champagne

Kelly Cluster, *Round Cluster System*,
composition of 36 lights, FINISH Matte White





Kelly Cluster, Special composition,
FINISH Coppery Bronze

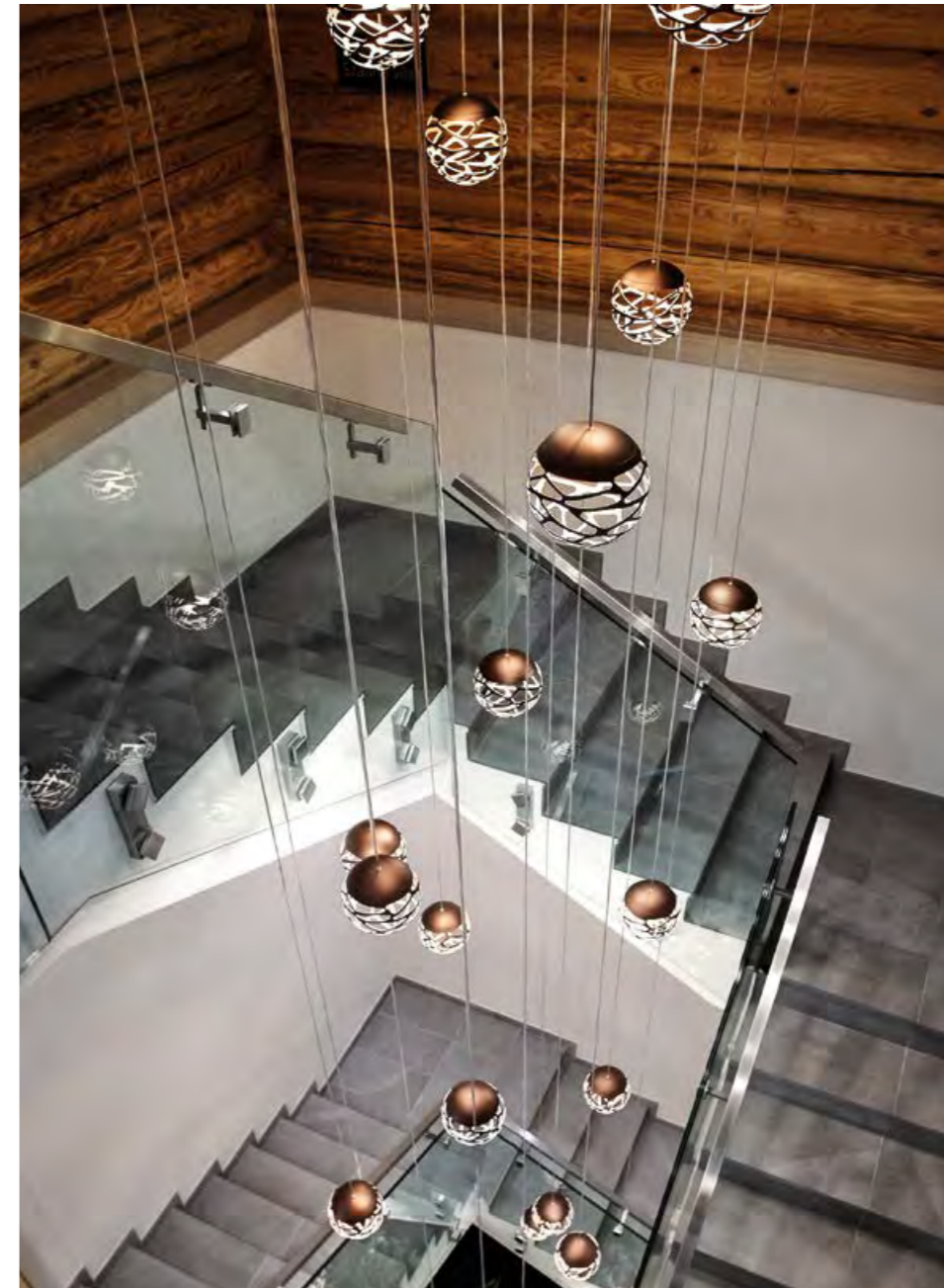

Kelly Cluster reformule brillamment l'intuition créative de la famille de lampes Kelly dans une sphère sculpturale et extrêmement compacte qui, montée sur une patère, permet de réaliser d'innombrables compositions. Lampe à suspension en métal, légère et animée grâce aux originales découpes laser qui créent de fascinants jeux de lumière et d'ombres ; plusieurs finitions disponibles pour valoriser tous les espaces. ● FR

Kelly Cluster formuliert die kreative Intuition der Leuchtenfamilie Kelly auf brillante Weise in einer skulpturellen und besonders kompakten Kugel wieder, die auf einem Baldachin montiert die Umsetzung verschiedener Kombinationen nach Wahl ermöglicht. Hängeleuchte aus Metall, die dank besonderer Laserschnitte leicht und lebhaft ist. Sie sorgen außerdem für faszinierende Spiele aus Licht und Schatten. Die Leuchte ist in vier verschiedenen Ausführungen erhältlich, um jeden Raum aufzuwerten. ● DE

Kelly Cluster reformula brillantemente la intuición creativa de la familia de lámparas Kelly en una esfera escultural y extremadamente compacta que, montada en un florón, permite crear múltiples composiciones a voluntad. Lámpara colgante de metal, ligera y alegre gracias a los cortes especiales de láser que crean fascinantes juegos de luz y sombra, está disponible en cuatro acabados diferentes capaces de resaltar cualquier ambiente. ● ES

Kelly Cluster блестяще обыгрывает в новом ключе творческую интуицию, воплощенную в семействе светильников Kelly, выполненных в скульптурной и необыкновенно компактной форме шара, монтируя который на потолочное крепление можно создавать множественные композиции на свой вкус. Металлический подвесной светильник с изящным и динамичным дизайном благодаря особым прорезям, выполненным методом лазерной резки и создающим чарующую игру света и тени, доступен в четырёх разных вариантах отделки, которые украсят любой интерьер. ● RU

Kelly Cluster在一个雕塑般紧凑的球体中巧妙地重新构造了Kelly灯家族系列的创意直觉,该球体安装在底盘上,可让您根据需要创建多种组合。金属制成的吊灯,光线明亮、活泼,这要归功于其特殊的激光切割工艺,可以产生引人入胜的光影效果,并提供四种不同的颜色,可以烘托任何环境。● ZH

Kelly Cluster ▸ Cluster suspension lamp

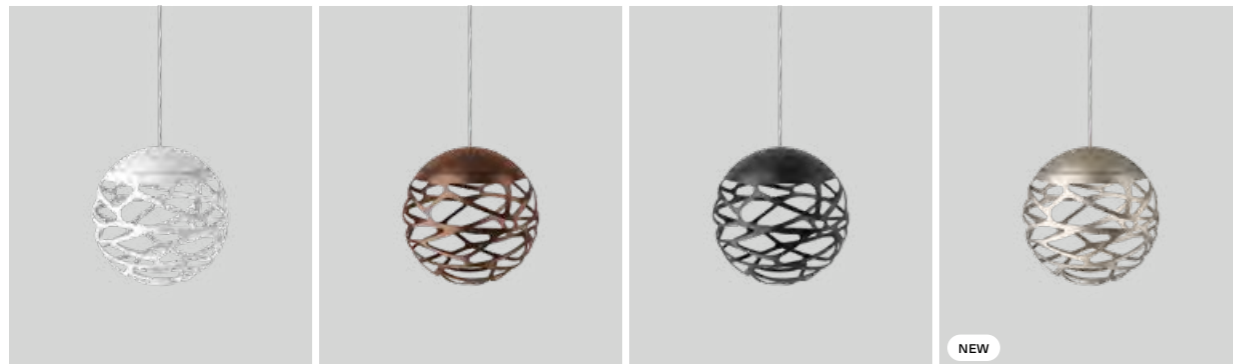

Kelly Cluster, design by Andrea Tosetto, 2015

Cluster suspension lamp

Kelly Cluster

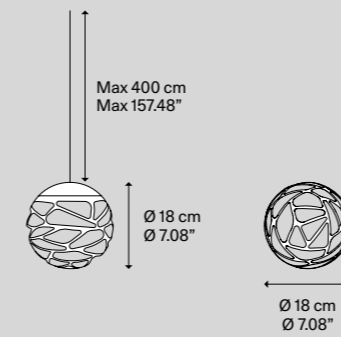

Light source
Sorgente luminosa

LED
 ▸ 2700 K
 ▸ 9 W/920 lm
 ▸ 220-240 V
 ▸ CRI 92
 ▸ MacAdam 3-Step

LED included
LED incluso

Metal structure
Montatura in metallo

- Matte White - 9010
Bianco Opaco - 9010
- Coppery Bronze
Bronzo Ramato
- Matte Black - 9005
Nero Opaco - 9005
- Matte Champagne ^{NEW}
Champagne Opaco

Glass diffuser
Diffusore in vetro

- Glossy White
Bianco Lucido

Code
Codice

- 147113
- 147114
- 147115
- 147116

Net weight/Peso netto: 1 kg

Pack/Colli: 1

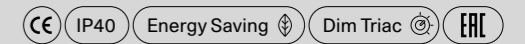

Suspension lamps must be installed on a canopy ▶ pag. 352-363
Le lampade a sospensione devono essere installate su rosone ▶ pag. 352-363

Example of composition

3 Lights Round Cluster

1 × 100014 1 × 147114 1 × 147115 1 × 147116

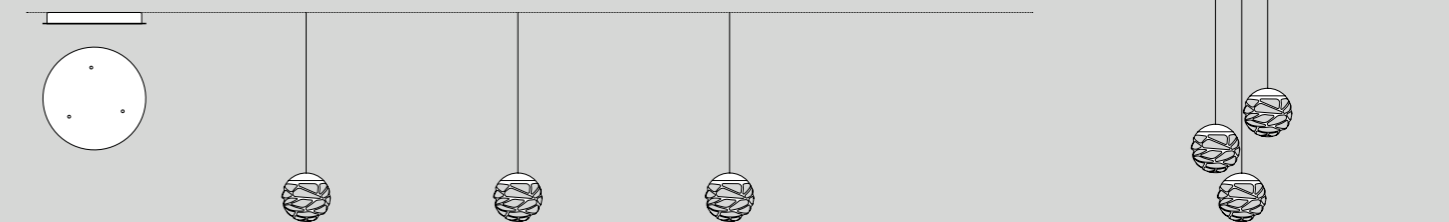

Example of composition

Short Lights Track

1 × 100029 5 × 147116

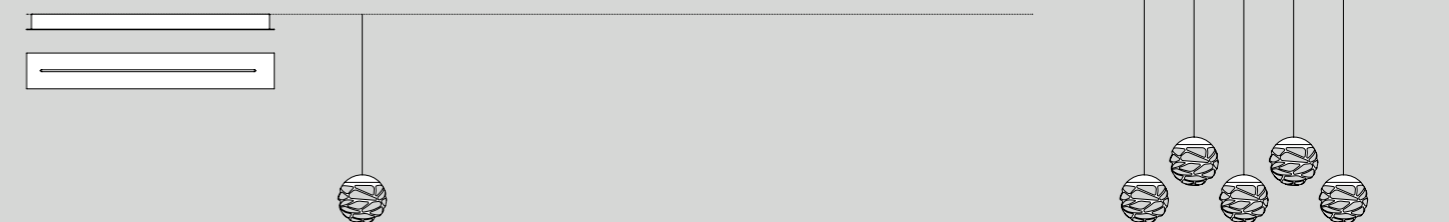

LED sources with direct power supply to the AC line voltage - driver not required. Dimmable with phase cut dimmer.

LED con alimentazione diretta a tensione di rete - non necessita di driver. Dimmerabile con varialuce a taglio di fase.

Kelly

Seductive beauty with a bold personality thanks to the strong and precise laser cuts, which lighten the metal of the lampshade and create an intriguing play of light and shadow. Kelly is a multifaceted family of suspension and wall lamps that stand out with elegance in any living space thanks to the variety of available forms and finishes.

Una bellezza seducente dalla personalità audace grazie a tagli laser forti e precisi che alleggeriscono il metallo del paralume e creano un intrigante gioco di luci e ombre. Kelly è una famiglia poliedrica di lampade a sospensione e a parete che si distingue con eleganza in ogni ambiente abitativo grazie alla varietà di forme e finiture disponibili.

Suspension lamp, Wall lamp

Kelly small dome 50, Kelly medium dome 60
and Kelly large dome 80, FINISH Matte White

Kelly, design by Andrea Toso, 2015

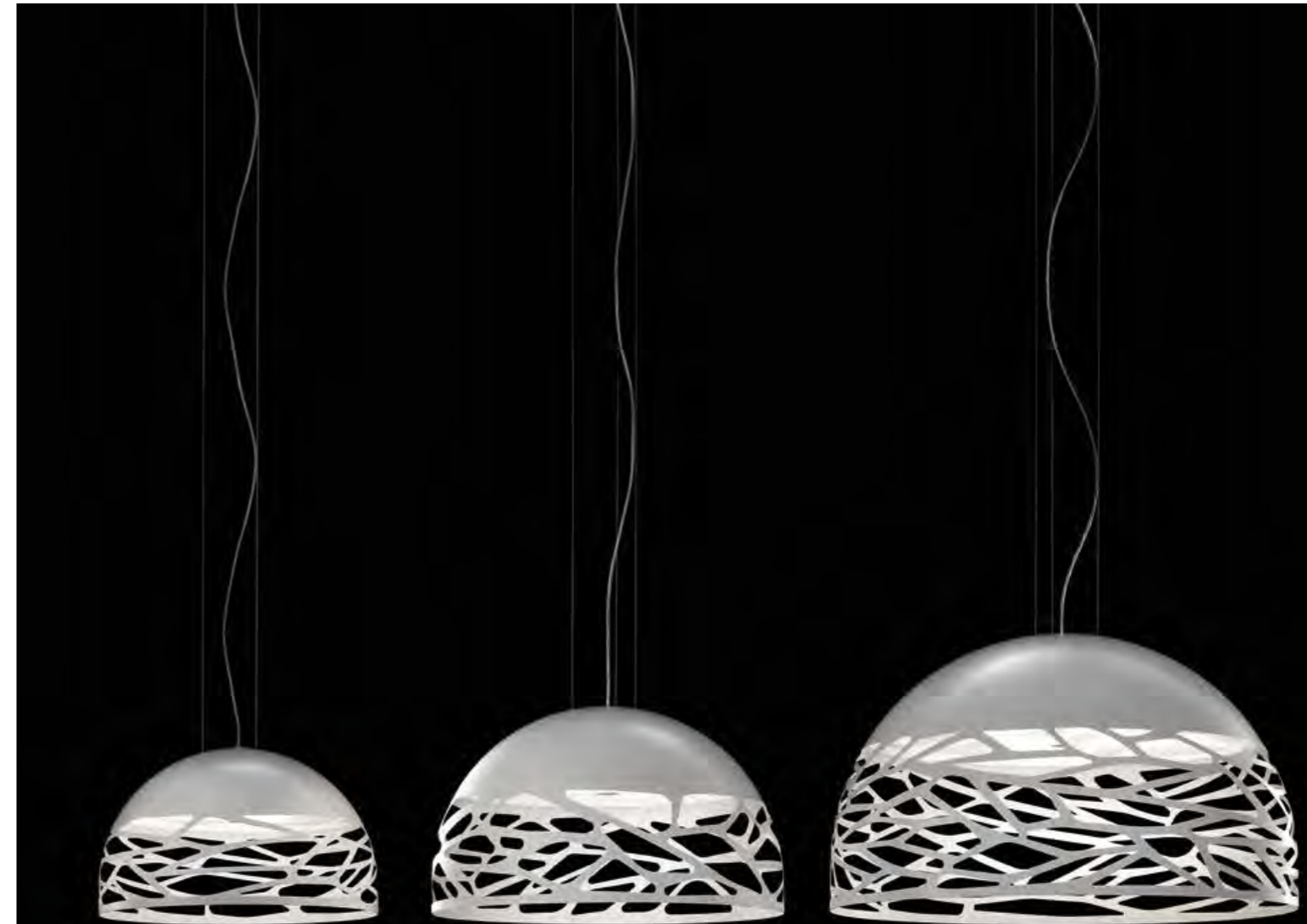



Kelly small dome 50, FINISH Matte Black

Kelly small dome 50,
FINISH Matte Black



Kelly medium dome 60, FINISH Matte White

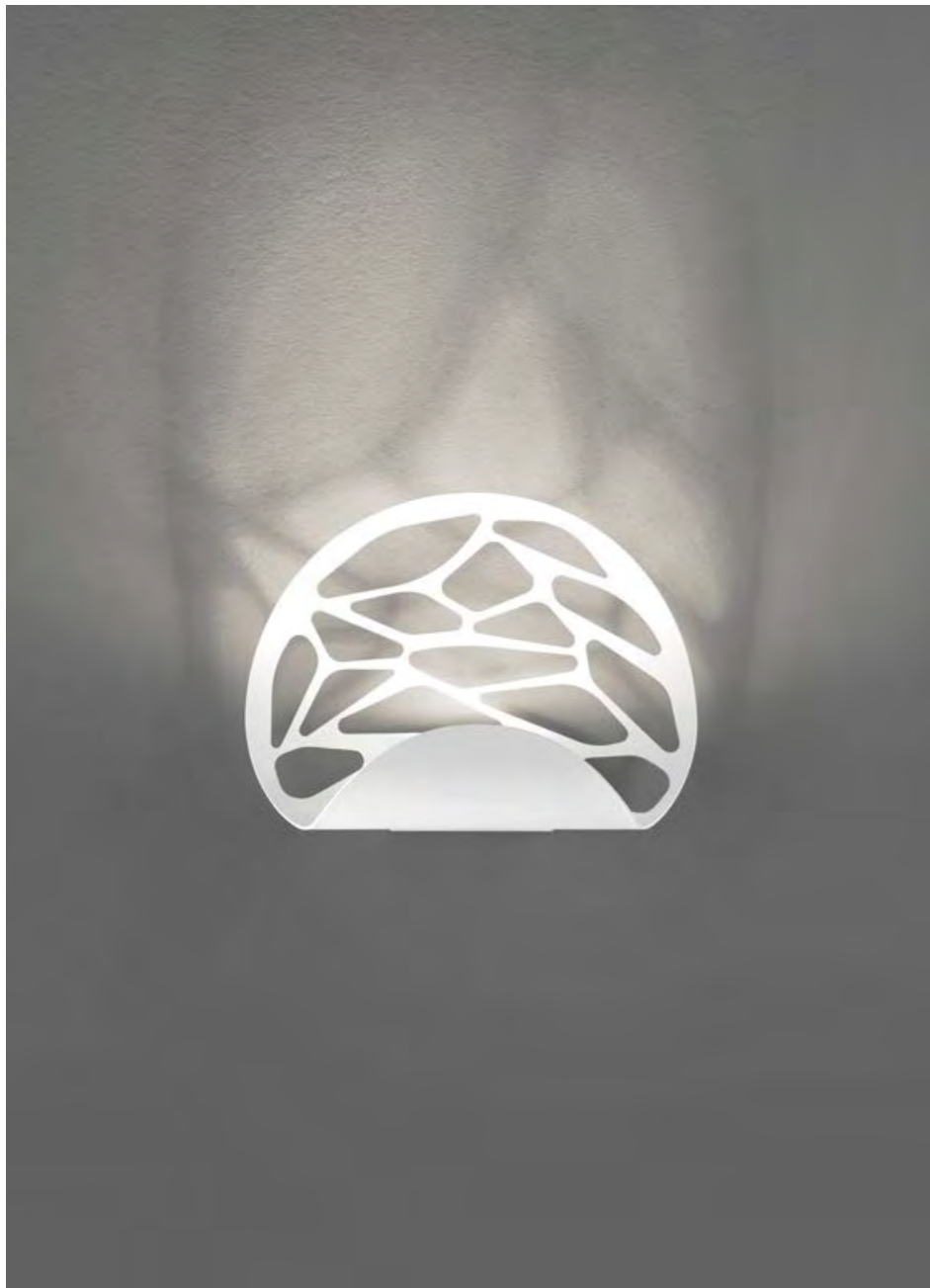

Kelly, FINISH Matte White

Kelly large dome 80,
FINISH Matte Champagne



Kelly small dome 50,
FINISH Coppery Bronze



Kelly small dome 50, FINISH Coppery Bronze

Kelly small sphere 40, Kelly medium sphere 50 and Kelly large sphere 80, FINISH Matte White



Kelly small sphere 40, Kelly medium sphere 50 and Kelly large sphere 80, FINISH Coppery Bronze

Une beauté séduisante d'une personnalité audacieuse grâce aux découpes laser puissantes et précises qui allègent le métal de l'abat-jour et créent un intrigant jeu de lumière et d'ombres. Kelly est une famille polyédrique de lampes à suspension et d'appliques qui se distingue avec élégance dans toutes les pièces de vie grâce à la variété de formes et de finitions disponibles. ● FR

Verführerische Schönheit mit gewagter Persönlichkeit, die durch starke und genaue Laserschnitte zum Ausdruck gebracht wird, die das Metall des Lampenschirms leicht erscheinen lassen und ein betrügerisches Spiel aus Licht und Schatten schaffen. Kelly ist eine vielseitige Familie aus Hänge- und Wandleuchten, die sich durch Eleganz in jedem Wohnraum auszeichnet, die den verschiedenen verfügbaren Formen und Ausführungen zu verdanken ist. ● DE

Una belleza seductora con una personalidad atrevida gracias a fuertes y precisos cortes de láser que iluminan el metal de la pantalla de la lámpara y crean un intrigante juego de luces y sombras. Kelly es una versátil familia de lámparas colgantes y de pared que destaca con elegancia en todos los entornos gracias a la variedad de formas y acabados disponibles. ● ES

Соблазнительная красота с решительным характером создана благодаря четким и выразительным прорезям, выполненным методом лазерной резки, которые облегчают металлический абажур и создают интригующую игру света и тени. Kelly – это семейство универсальных подвесных и настенных светильников, которые элегантно украшают любой жилой интерьер благодаря разнообразию доступных форм и отделки. ● RU

强劲而精确的激光切割使灯罩的金属发亮，并创造出有趣的光影效果，具有诱人的美感和大胆的个性。Kelly是一个悬吊式和壁灯系列的产品，其多种多样的外形和颜色使其在任何生活环境中均格外高雅。● ZH

Kelly small dome 50 ↘ Suspension lamp



Kelly medium dome 60 ↘ Suspension lamp

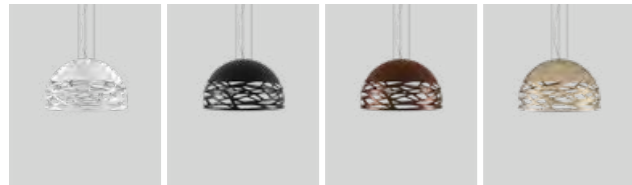

Kelly large dome 80 ↘ Suspension lamp



Kelly ↘ Wall lamp



Kelly, design by Andrea Tosetto, 2015

Suspension lamp

Kelly small dome 50

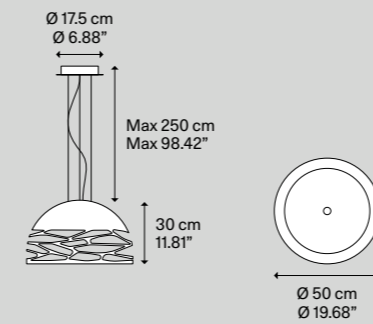

Net weight/Peso netto: 6 kg

Pack/Colli: 1

Light source Sorgente luminosa

E27 Classic A60
↘ 3 × max 46 W Eco



or

E27 LED
↘ 3 × 25 W
(W/L max 12 cm)



Bulbs not included
Lampadine non include

Metal structure Montatura in metallo

● Matte White – 9010
Bianco Opaco – 9010

● Matte Black – 9005
Nero Opaco – 9005

● Coppery Bronze
Bronzo Ramato

● Matte Champagne
Champagne Opaco

Glass diffuser Diffusore in vetro

● Glossy White
Bianco Lucido

● Glossy White
Bianco Lucido

● Glossy White
Bianco Lucido

● Glossy White
Bianco Lucido

Code Codice

141002

141016

141009

141019

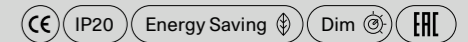

Kelly medium dome 60

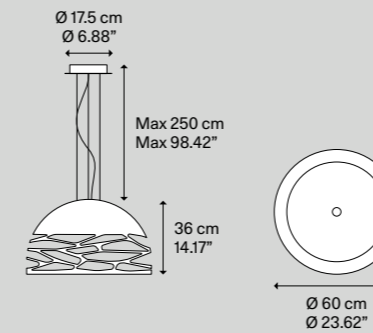

Net weight/Peso netto: 7.15 kg

Pack/Colli: 1

E27 Classic A60
↘ 3 × max 46 W Eco



or

E27 LED
↘ 3 × 25 W
(W/L max 12 cm)



Bulbs not included
Lampadine non include

● Matte White – 9010
Bianco Opaco – 9010

● Matte Black – 9005
Nero Opaco – 9005

● Coppery Bronze
Bronzo Ramato

● Matte Champagne
Champagne Opaco

● Glossy White
Bianco Lucido

● Glossy White
Bianco Lucido

● Glossy White
Bianco Lucido

● Glossy White
Bianco Lucido

141013

141018

141014

141020

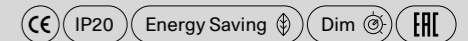

Kelly large dome 80

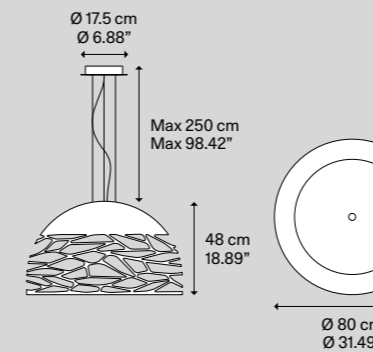

Net weight/Peso netto: 11 kg

Pack/Colli: 1

E27 Classic A60
↘ 4 × max 46 W Eco



or

E27 LED
↘ 4 × 25 W
(W/L max 12 cm)



Bulbs not included
Lampadine non include

● Matte White – 9010
Bianco Opaco – 9010

● Matte Black – 9005
Nero Opaco – 9005

● Coppery Bronze
Bronzo Ramato

● Matte Champagne
Champagne Opaco

● Glossy White
Bianco Lucido

● Glossy White
Bianco Lucido

● Glossy White
Bianco Lucido

● Glossy White
Bianco Lucido

141001

141017

141010

141021

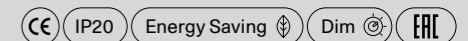

Kelly, design by Andrea Tosetto, 2015

Suspension lamp

Kelly small sphere 40

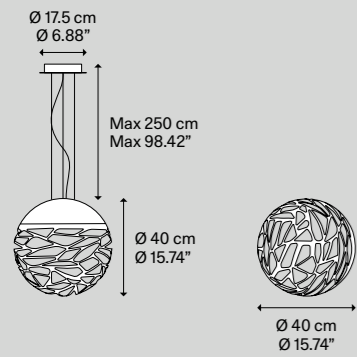

Light source Sorgente luminosa	Metal structure Montatura in metallo	Glass diffuser Diffusore in vetro	Code Codice
E27 Classic A60 ↘ 3 × max 46 W Eco 	Matte White – 9010 Bianco Opaco – 9010	Glossy White Bianco Lucido	141003
E27 LED ↘ 3 × 25 W (W/L max 12 cm) 	Coppery Bronze Bronzo Ramato		141250
Bulbs not included Lampadine non incluse			

Net weight/Peso netto: 5.5 kg Pack/Colli: 2

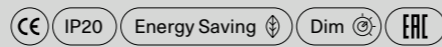

Kelly medium sphere 50

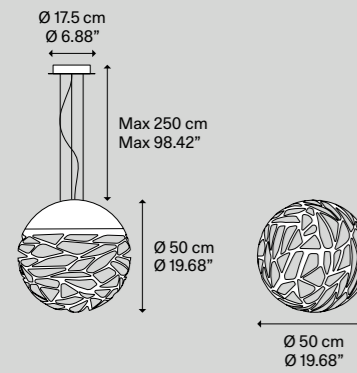

Light source Sorgente luminosa	Metal structure Montatura in metallo	Glass diffuser Diffusore in vetro	Code Codice
E27 Classic A60 ↘ 3 × max 46 W Eco 	Matte White – 9010 Bianco Opaco – 9010	Glossy White Bianco Lucido	141004
E27 LED ↘ 3 × 25 W (W/L max 12 cm) 	Coppery Bronze Bronzo Ramato		141269
Bulbs not included Lampadine non incluse			

Net weight/Peso netto: 9 kg Pack/Colli: 2

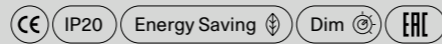

Kelly large sphere 80

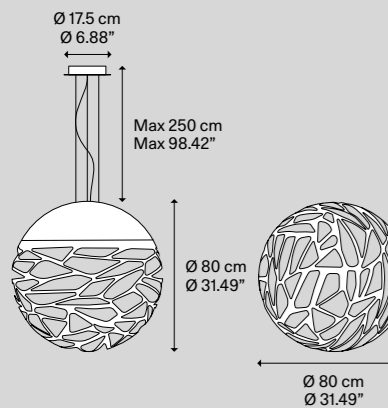

Light source Sorgente luminosa	Metal structure Montatura in metallo	Glass diffuser Diffusore in vetro	Code Codice
E27 Classic A60 ↘ 4 × max 46 W Eco 	Matte White – 9010 Bianco Opaco – 9010	Glossy White Bianco Lucido	141005
E27 LED ↘ 4 × 25 W (W/L max 12 cm) 	Coppery Bronze Bronzo Ramato		141270
Bulbs not included Lampadine non incluse			

Net weight/Peso netto: 15 kg Pack/Colli: 2

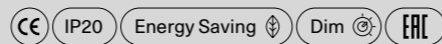

Kelly, design by Andrea Tosetto, 2015

Wall lamp

Kelly



Light source Sorgente luminosa	Metal structure Montatura in metallo	Code Codice
LED ↘ 2700 K ↘ 16 W/1700 lm ↘ 220-220 V ↘ CRI 92 ↘ MacAdam 3-Step	Matte White – 9010 Bianco Opaco – 9010	141011
LED included LED incluso	Coppery Bronze Bronzo Ramato	141012

Net weight/Peso netto: 0.8 kg Pack/Colli: 1

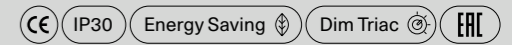

Laser

Laser is a compact, versatile light fixture in the shape of a box with an attractive architectural look. From its painted steel structure, available in two sizes and three different finishes, the LED light source diffuses a functional and evocative two-way light that creates plays of light and shadow on the wall.

Laser è una lampada compatta a forma di parallelepipedo dal carattere versatile e architettonico. Dalla sua struttura in acciaio verniciato, disponibile in due dimensioni e in tre diverse finiture, la sorgente a LED diffonde una luce bidirezionale funzionale e d'effetto che crea giochi di luce ed ombra sulla parete.

Wall lamp

Laser 10 × 6,
FINISH Coppery Bronze

Laser, *design by* Studio Italia Design, 2005/2015



Laser est une lampe compacte en forme de parallélépipède au caractère polyvalent et architectural. De sa structure en acier peint, disponible en deux tailles et en trois finitions différentes, la source LED diffuse une lumière bidirectionnelle fonctionnelle et efficace qui crée des jeux d'ombre et de lumière sur le mur. ●FR

Laser ist eine kompakte Lampe in Form eines Parallelepipedes mit vielseitigem und architektonischem Charakter. Durch seine Armatur aus lackiertem Stahl, die in zwei Größen und drei unterschiedlichen Ausführungen verfügbar ist, verbreitet die LED-Lichtquelle bidirektionales, funktionelles sowie effektvolles Licht, wodurch ein Spiel aus Licht und Schatten an der Wand entsteht. ●DE

Laser es una lámpara compacta con forma de paralelepípedo con carácter versátil y arquitectónico. De su estructura de acero pintado, disponible en dos dimensiones y en tres diferentes acabados, la fuente de LED difunde una luz bidireccional funcional y con efecto que crea juegos de luz y sombra en la pared. ●ES

Laser – компактный светильник в форме параллелепипеда с многогранным архитектурным характером. Конструкция светильника выполнена из окрашенной стали, доступной в двух размерах и трех различных вариантах отделки. Светодиодный источник эффективно рассеивает двунаправленный свет, создающий на стене игру света и тени. ●RU

Laser是一款四边形的紧凑灯具，具有建筑美感，广泛适用。喷漆钢材的结构，提供两种尺寸，三种不同的颜色，LED光源散发着双向的功能灯光，在墙壁上形成光影效果。●ZH

Laser 10 × 6 ↘ Wall lamp

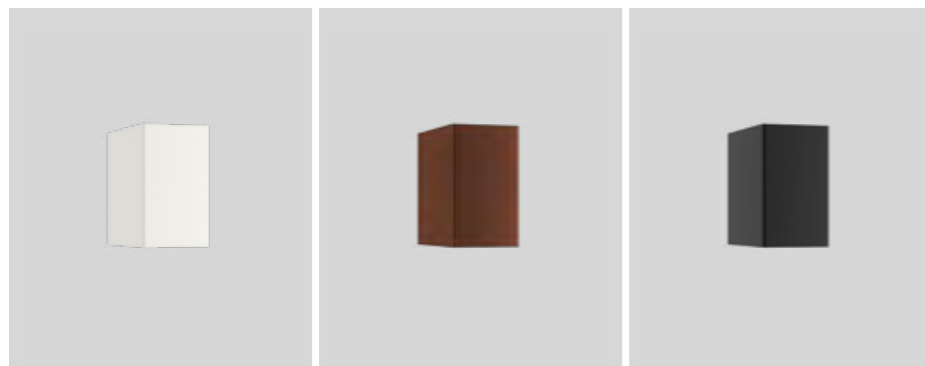

Laser 10 × 10 ↘ Wall lamp

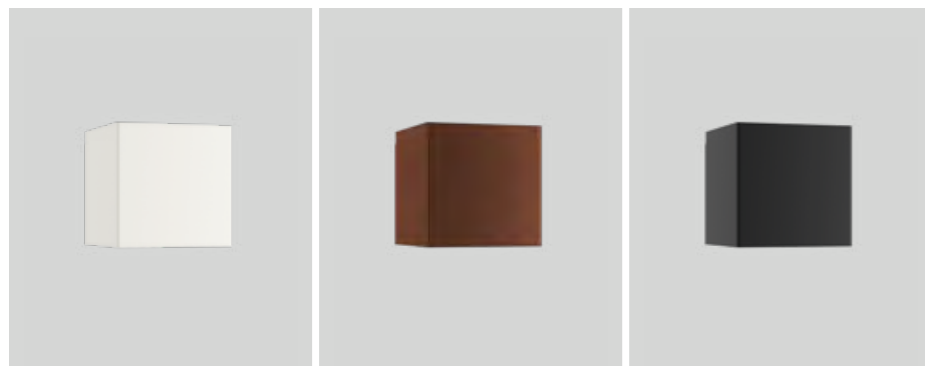

Laser, design by Studio Italia Design, 2005/2015

Wall lamp

Laser 10 × 6 LED

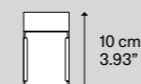
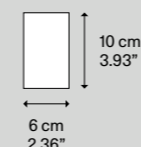

Light source
Sorgente luminosa

LED
↘ 2700 K
↘ 9 W/920 lm
↘ 220-240 V
↘ CRI 92
↘ MacAdam 3-Step

or

LED
↘ 3000 K
↘ 9 W/980 lm
↘ 220-240 V
↘ CRI 92
↘ MacAdam 3-Step

LED included
LED incluso

Metal structure
Montatura in metallo

● Matte White - 9010
Bianco Opaco - 9010

● Coppery Bronze
Bronzo Ramato

● Matte Black - 9005
Nero Opaco - 9005

● Matte White - 9010
Bianco Opaco - 9010

● Coppery Bronze
Bronzo Ramato

● Matte Black - 9005
Nero Opaco - 9005

Code
Codice

036027

036028

036032

036023

036024

036031

Net weight/Peso netto: 0.5 kg

Pack/Colli: 1

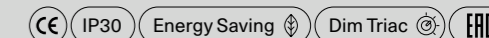

Laser 10 × 10 LED

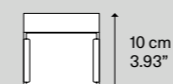
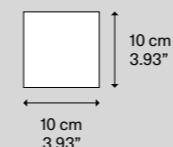

LED
↘ 2700 K
↘ 16 W/1700 lm
↘ 220-240 V
↘ CRI 92
↘ MacAdam 3-Step

or

LED
↘ 3000 K
↘ 16 W/1800 lm
↘ 220-240 V
↘ CRI 92
↘ MacAdam 3-Step

LED included
LED incluso

● Matte White - 9010
Bianco Opaco - 9010

● Coppery Bronze
Bronzo Ramato

● Matte Black - 9005
Nero Opaco - 9005

● Matte White - 9010
Bianco Opaco - 9010

● Coppery Bronze
Bronzo Ramato

● Matte Black - 9005
Nero Opaco - 9005

036029

036030

036034

036025

036026

036033

Net weight/Peso netto: 0.6 kg

Pack/Colli: 1

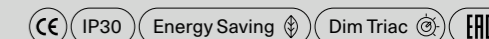

Aile

The new Aile aluminium wall lamp features a simple and dynamic design reminiscing the aileron of sport cars, after which it has been named. Aile's compact size, sleek design, powerful light output with respect to its dimensions and four rich finishes offer a complete lighting solution even for more intimate settings.

Aile, nuova lampada da parete in alluminio, presenta un design semplice e dinamico, proprio come l'alettone delle auto sportive, *aileron* in inglese, da cui prende il nome. La compattezza, il design elegante, la forte capacità di emissione di luce rispetto alle dimensioni e le quattro ricche finiture rendono Aile una soluzione perfetta anche per illuminare ambienti raccolti.

Wall lamp

Aile, *design by* Luca Nichetto, 2021



Aile,
FINISH Lacquer Red

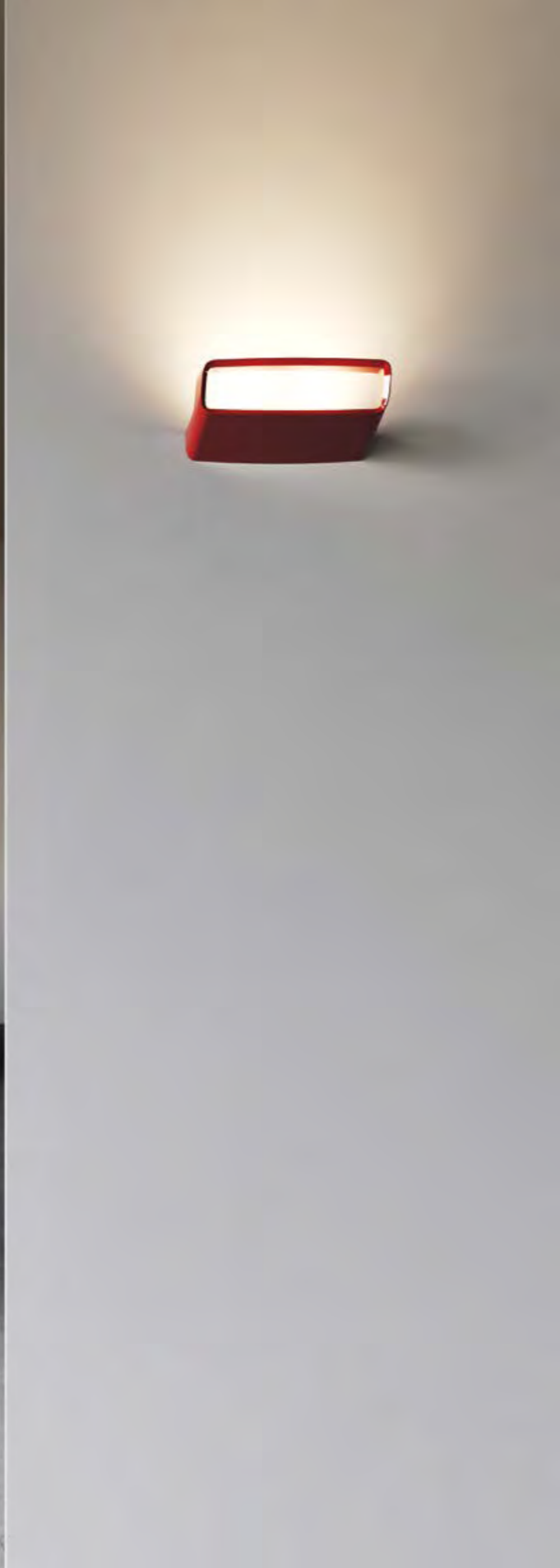

Aile, FINISH Lacquer Red





Aile, FINISH Champagne



1



2

1–Aile, FINISH Matte White

2–Aile, FINISH Matte Black



Aile, FINISH Matte White

275

Aile

Wall lamp

Légère applique en aluminium, la nouvelle Aile présente un design simple et dynamique rappelant l'aileron d'une voiture de sport dont le nom s'inspire. La taille compacte d'Aile, son design élégant, son rayonnement lumineux puissant par rapport aux dimensions et ses quatre riches finitions offrent une solution d'éclairage complète, même pour des espaces plus intimes. ●FR

Die neue Aile Aluminium-Wandleuchte zeichnet sich durch ein schlichtes Design mit einer dynamischen Form aus, die an das Querruder eines Sportwagens erinnert –aileron auf Englisch, nach dem sie benannt wurde. Ailes kompakte Größe, das schlanke Design und die starke Lichtleistung im Vergleich zur Fläche bieten eine komplette Beleuchtungslösung sogar für intimere Umgebungen. ●DE

Ligera lámpara de pared en aluminio, la nueva Aile presenta un diseño sencillo y dinámico que recuerda el alerón de un automóvil deportivo, aileron en inglés, que a su vez le da nombre. El tamaño compacto, el diseño elegante, la potente salida de luz con respecto a sus dimensiones y los cuatro ricos acabados hacen que Aile sea una solución de iluminación completa incluso para entornos más íntimos. ●ES

Новая настенная алюминиевая лампа Aile отличается простым дизайном и динамичной формой, напоминающей элероны спортивных автомобилей, «aileron» на английском, в честь которых она и получила свое название. Компактный размер, элегантный дизайн, мощная светоотдача, по сравнению с ее размерами, а также четыре варианта богатой отделки делают из Aile идеальное решение также для освещения более интимных уголков. ●RU

全新Aile铝制壁灯拥有简约大方且与动感十足的设计,令人联想至跑车的副翼,从而以此得名。Aile紧凑的尺寸、时尚的设计、相对其尺寸的强大光线输出以及四款丰富的饰面,为更多甚为私密的环境设置提供了一项完整的照明解决方案。●ZH

Aile, design by Luca Nichetto, 2021

Wall lamp

Aile NEW

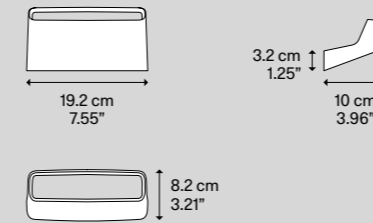

Light source Sorgente luminosa

LED
↘ 2700 K
↘ 2 × 9 W / 1840 lm
↘ 220-240 V
↘ CRI 92
↘ MacAdam 3-Step

or

LED
↘ 3000 K
↘ 2 × 9 W / 1960 lm
↘ 220-240 V
↘ CRI 92
↘ MacAdam 3-Step

LED included
LED incluso

Metal structure Montatura in metallo

● Matte White - 9010
Bianco Opaco - 9010

● Matte Black - 9005
Nero Opaco - 9005

● Champagne
Champagne

● Lacquer Red
Rosso Lacca

● Matte White - 9010
Bianco Opaco - 9010

● Matte Black - 9005
Nero Opaco - 9005

● Champagne
Champagne

● Lacquer Red
Rosso Lacca

Code Codice

175001

175002

175007

175003

175004

175005

175008

175006

Net weight/Peso netto: 0.55 kg

Pack/Colli: 1

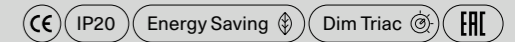

Aile ▾ Wall lamp NEW LAMP

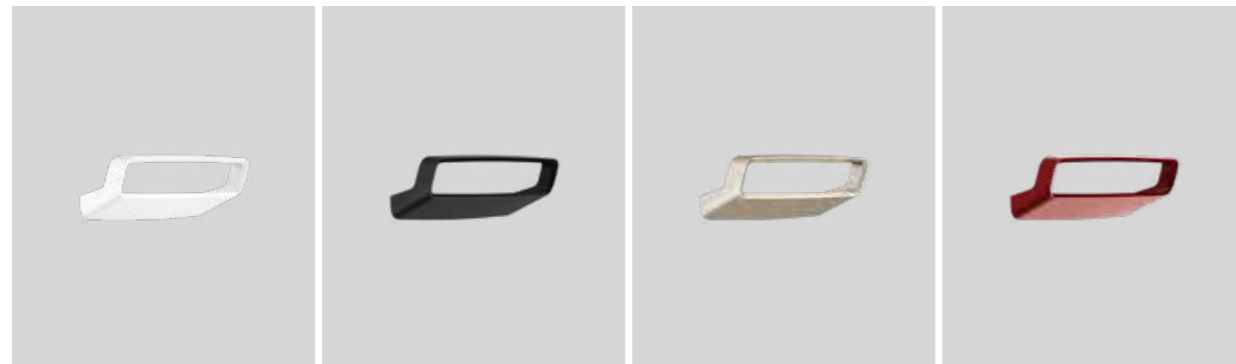

Puzzle Mega

Large geometric figures characterised by essential forms, which almost merge with the interior architecture when off, only to be surprisingly revealed as harmonies of light and shadow when lit. Puzzle Mega lamps decorate walls and ceiling with light.

Grandi figure geometriche dalle forme essenziali che quasi si fondono con l'architettura interna quando sono spente, per rivelare inaspettate armonie di luci e ombre una volta accese. Le lampade Puzzle Mega consentono di decorare con la luce pareti e soffitti.

Wall lamp, Ceiling lamp

Puzzle Mega round small,
FINISHES Matte White and Renoir by Infinity™

Puzzle Mega, *design by* Studio Italia Design, 2019



Puzzle Mega square large,
FINISHES Matte White and Renoir by Infinity™



Puzzle Mega composition, FINISH Renoir by Infinity™





Puzzle Mega compositions, FINISHES Matte White and Renoir by Infinity™



Puzzle Mega round small and large, FINISH Matte White

Puzzle Mega round small,
FINISH Matte White



Puzzle Mega round small,
standard version and extension optional version,
FINISH Matte White

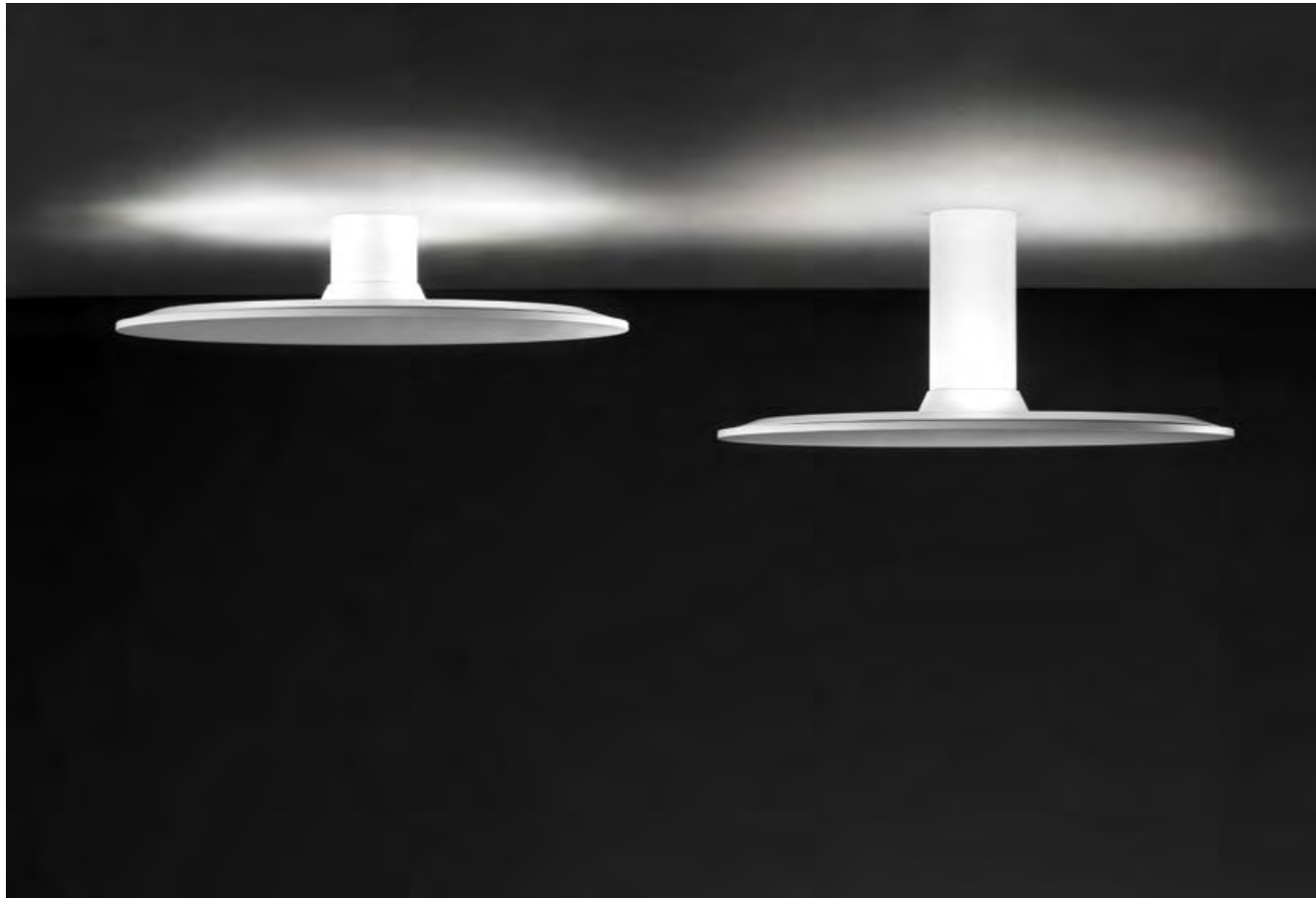

Grandes figures géométriques aux formes essentielles qui se fondent presque dans l'architecture interne lorsqu'elles sont éteintes, pour révéler d'inattendues harmonies de lumière et d'ombres une fois éclairées. Les lampes Puzzle Mega permettent de décorer avec la lumière les murs et les plafonds. ● FR

Große geometrische Figuren in einfacher Form, die ausgeschaltet mit der Innenarchitektur verschmelzen, um eingeschaltet eine unerwartete Harmonie aus Licht und Schatten entstehen zu lassen. Die Leuchten Puzzle Mega ermöglichen mit ihrem Licht Wände und Decken zu dekorieren. ● DE

Grandes figuras geométricas con formas esenciales que casi se mezclan con la arquitectura interior cuando se apagan, para revelar inesperadas armonías de luz y sombras una vez encendidas. Las lámparas Puzzle Mega permiten decorar las paredes y los techos con la luz. ● ES

该灯具具有大型几何图形的基本形状，关闭时，几乎与内部架构融为一体，一旦打开，会发现意想不到的光影和谐。Puzzle Mega灯具可让您用灯光装饰墙壁和天花板。● ZH

Крупные геометрические фигуры с простыми строгими формами, которые почти полностью сливаются с архитектурой интерьера, когда они выключены. Но стоит их включить, как вы увидите неожиданную и гармоничную игру света и тени. Светильники Puzzle Mega позволяют декорировать светом стены и потолки. ● RU

Puzzle Mega round small › Wall lamp

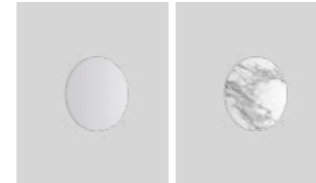

Puzzle Mega round large › Wall lamp

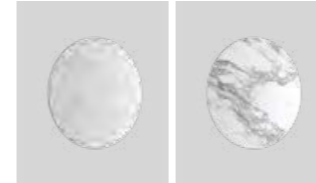

Puzzle Mega square small › Wall lamp



Puzzle Mega square large › Wall lamp



Puzzle Mega rectangular › Wall lamp



Puzzle Mega round small › Ceiling lamp

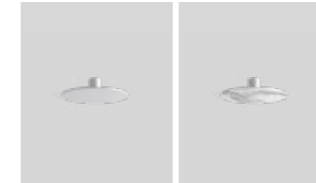

Puzzle Mega round large › Ceiling lamp



Puzzle Mega square small › Ceiling lamp

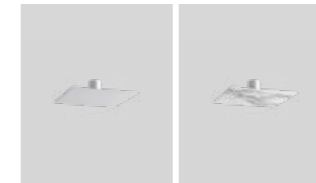

Puzzle Mega square large › Ceiling lamp

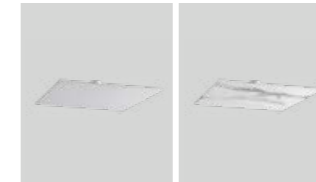

Puzzle Mega rectangular › Ceiling lamp

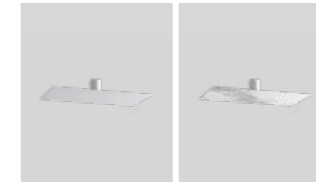

Puzzle Mega, design by Studio Italia Design, 2019

Wall lamp Ceiling lamp

Puzzle Mega round small

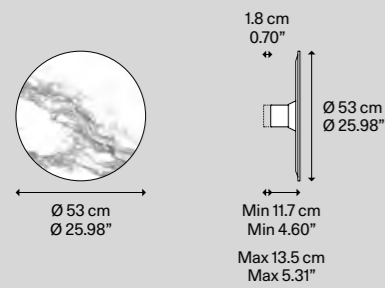

Light source Sorgente luminosa	Metal structure Montatura in metallo	Fine Porcelain Stoneware diffuser Diffusore in Gres Porcellanato	Code Codice
LED ↘ 2700 K ↘ 3 × 16 W/5100 lm ↘ 220-240 V ↘ CRI 92 ↘ MacAdam 3-Step	Matte White – 9016 Bianco Opaco – 9016	Renoir by Infinity™	167001
LED ↘ 3000 K ↘ 3 × 16 W/5400 lm ↘ 220-240 V ↘ CRI 92 ↘ MacAdam 3-Step	Matte White – 9016 Bianco Opaco – 9016	Renoir by Infinity™	167002

LED included
LED incluso

Net weight/Peso netto: 5.6 kg Pack/Colli: 2

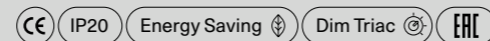

Puzzle Mega round small

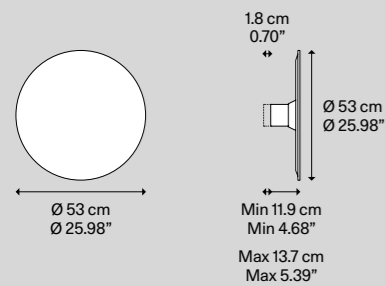

Light source Sorgente luminosa	Metal structure Montatura in metallo	MDF diffuser Diffusore in MDF	Code Codice
LED ↘ 2700 K ↘ 3 × 16 W/5100 lm ↘ 220-240 V ↘ CRI 92 ↘ MacAdam 3-Step	Matte White – 9016 Bianco Opaco – 9016	Matte White – 9016 Bianco Opaco – 9016	167011
LED ↘ 3000 K ↘ 3 × 16 W/5400 lm ↘ 220-240 V ↘ CRI 92 ↘ MacAdam 3-Step	Matte White – 9016 Bianco Opaco – 9016	Matte White – 9016 Bianco Opaco – 9016	167012

LED included
LED incluso

Net weight/Peso netto: 3.8 kg Pack/Colli: 2

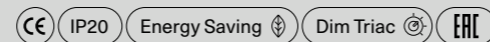

► LED sources with direct power supply to the AC line voltage – driver not required. Dimmable with phase cut dimmer.
► You can connect up to 4 Puzzle Mega to each fixture directly connected to the power supply. You can also connect up to 3 additional fixtures to each of those for maximum total of 36 fixtures on a single power outlet.

► LED con alimentazione diretta a tensione di rete – non necessita di driver. Dimmerabile con varialuce a taglio di fase.
► Ad ogni Puzzle Mega connessa al punto di alimentazione elettrica possono esserne collegate altre 4. Ad ognuna di queste possono esserne collegate fino ad altre 3 e così via. Le lampade totali collegabili su un singolo punto di alimentazione sono 36.

Puzzle Mega, design by Studio Italia Design, 2019

Wall lamp Ceiling lamp

Puzzle Mega round large

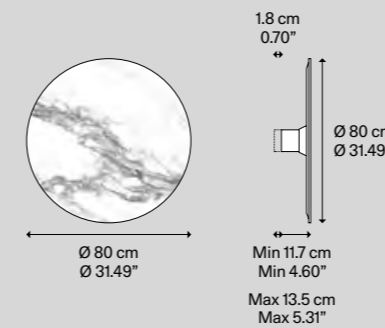

Light source Sorgente luminosa	Metal structure Montatura in metallo	Fine Porcelain Stoneware diffuser Diffusore in Gres Porcellanato	Code Codice
LED ↘ 2700 K ↘ 4 × 16 W/6800 lm ↘ 220-240 V ↘ CRI 92 ↘ MacAdam 3-Step	Matte White – 9016 Bianco Opaco – 9016	Renoir by Infinity™	167003
LED ↘ 3000 K ↘ 4 × 16 W/7200 lm ↘ 220-240 V ↘ CRI 92 ↘ MacAdam 3-Step	Matte White – 9016 Bianco Opaco – 9016	Renoir by Infinity™	167004

LED included
LED incluso

Net weight/Peso netto: 11 kg Pack/Colli: 2

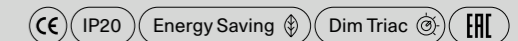

Puzzle Mega round large

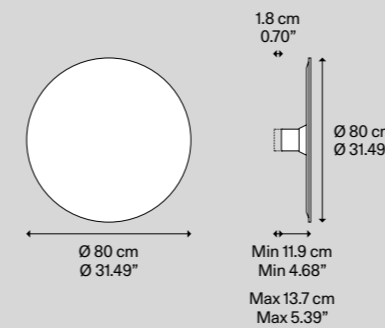

Light source Sorgente luminosa	Metal structure Montatura in metallo	MDF diffuser Diffusore in MDF	Code Codice
LED ↘ 2700 K ↘ 4 × 16 W/6800 lm ↘ 220-240 V ↘ CRI 92 ↘ MacAdam 3-Step	Matte White – 9016 Bianco Opaco – 9016	Matte White – 9016 Bianco Opaco – 9016	167013
LED ↘ 3000 K ↘ 4 × 16 W/7200 lm ↘ 220-240 V ↘ CRI 92 ↘ MacAdam 3-Step	Matte White – 9016 Bianco Opaco – 9016	Matte White – 9016 Bianco Opaco – 9016	167014

LED included
LED incluso

Net weight/Peso netto: 7.2 kg Pack/Colli: 2

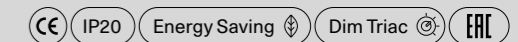

► LED sources with direct power supply to the AC line voltage – driver not required. Dimmable with phase cut dimmer.
► You can connect up to 4 Puzzle Mega to each fixture directly connected to the power supply. You can also connect up to 3 additional fixtures to each of those for maximum total of 36 fixtures on a single power outlet.

► LED con alimentazione diretta a tensione di rete – non necessita di driver. Dimmerabile con varialuce a taglio di fase.
► Ad ogni Puzzle Mega connessa al punto di alimentazione elettrica possono esserne collegate altre 4. Ad ognuna di queste possono esserne collegate fino ad altre 3 e così via. Le lampade totali collegabili su un singolo punto di alimentazione sono 36.

Puzzle Mega, design by Studio Italia Design, 2019

Wall lamp Ceiling lamp

Puzzle Mega square small

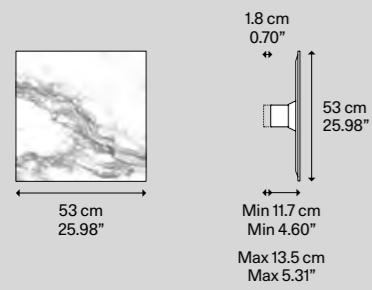

Light source Sorgente luminosa	Metal structure Montatura in metallo	Fine Porcelain Stoneware diffuser Diffusore in Gres Porcellanato	Code Codice
LED ↘ 2700 K ↘ 3 × 16 W/5100 lm ↘ 220-240 V ↘ CRI 92 ↘ MacAdam 3-Step	Matte White – 9016 Bianco Opaco – 9016	Renoir by Infinity™	167005
LED ↘ 3000 K ↘ 3 × 16 W/5400 lm ↘ 220-240 V ↘ CRI 92 ↘ MacAdam 3-Step	Matte White – 9016 Bianco Opaco – 9016	Renoir by Infinity™	167006

LED included
LED incluso

Net weight/Peso netto: 6.4 kg Pack/Colli: 2

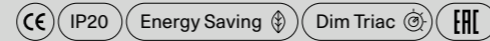

Puzzle Mega square small

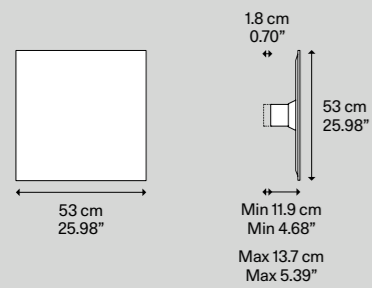

Light source Sorgente luminosa	Metal structure Montatura in metallo	MDF diffuser Diffusore in MDF	Code Codice
LED ↘ 2700 K ↘ 3 × 16 W/5100 lm ↘ 220-240 V ↘ CRI 92 ↘ MacAdam 3-Step	Matte White – 9016 Bianco Opaco – 9016	Matte White – 9016 Bianco Opaco – 9016	167015
LED ↘ 3000 K ↘ 3 × 16 W/5400 lm ↘ 220-240 V ↘ CRI 92 ↘ MacAdam 3-Step	Matte White – 9016 Bianco Opaco – 9016	Matte White – 9016 Bianco Opaco – 9016	167016

LED included
LED incluso

Net weight/Peso netto: 4.1 kg Pack/Colli: 2

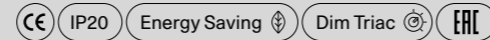

► LED sources with direct power supply to the AC line voltage – driver not required. Dimmable with phase cut dimmer.
► You can connect up to 4 Puzzle Mega to each fixture directly connected to the power supply. You can also connect up to 3 additional fixtures to each of those for maximum total of 36 fixtures on a single power outlet.

► LED con alimentazione diretta a tensione di rete – non necessita di driver. Dimmerabile con varialuce a taglio di fase.
► Ad ogni Puzzle Mega connessa al punto di alimentazione elettrica possono esserne collegate altre 4. Ad ognuna di queste possono esserne collegate fino ad altre 3 e così via. Le lampade totali collegabili su un singolo punto di alimentazione sono 36.

Puzzle Mega, design by Studio Italia Design, 2019

Wall lamp Ceiling lamp

Puzzle Mega square large

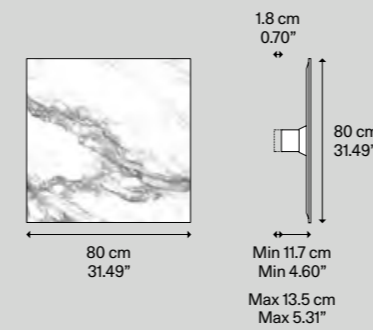

Light source Sorgente luminosa	Metal structure Montatura in metallo	Fine Porcelain Stoneware diffuser Diffusore in Gres Porcellanato	Code Codice
LED ↘ 2700 K ↘ 4 × 16 W/6800 lm ↘ 220-240 V ↘ CRI 92 ↘ MacAdam 3-Step	Matte White – 9016 Bianco Opaco – 9016	Renoir by Infinity™	167007
LED ↘ 3000 K ↘ 4 × 16 W/7200 lm ↘ 220-240 V ↘ CRI 92 ↘ MacAdam 3-Step	Matte White – 9016 Bianco Opaco – 9016	Renoir by Infinity™	167008

LED included
LED incluso

Net weight/Peso netto: 13.4 kg Pack/Colli: 2

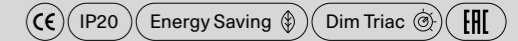

Puzzle Mega square large

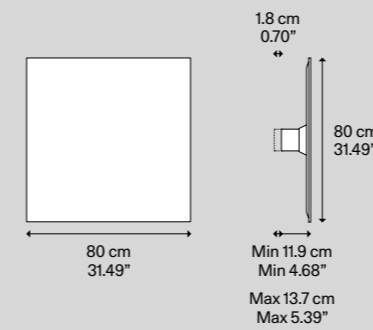

Light source Sorgente luminosa	Metal structure Montatura in metallo	MDF diffuser Diffusore in MDF	Code Codice
LED ↘ 2700 K ↘ 4 × 16 W/6800 lm ↘ 220-240 V ↘ CRI 92 ↘ MacAdam 3-Step	Matte White – 9016 Bianco Opaco – 9016	Matte White – 9016 Bianco Opaco – 9016	167017
LED ↘ 3000 K ↘ 4 × 16 W/7200 lm ↘ 220-240 V ↘ CRI 92 ↘ MacAdam 3-Step	Matte White – 9016 Bianco Opaco – 9016	Matte White – 9016 Bianco Opaco – 9016	167018

LED included
LED incluso

Net weight/Peso netto: 8.8 kg Pack/Colli: 2

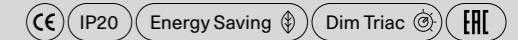

► LED sources with direct power supply to the AC line voltage – driver not required. Dimmable with phase cut dimmer.
► You can connect up to 4 Puzzle Mega to each fixture directly connected to the power supply. You can also connect up to 3 additional fixtures to each of those for maximum total of 36 fixtures on a single power outlet.

► LED con alimentazione diretta a tensione di rete – non necessita di driver. Dimmerabile con varialuce a taglio di fase.
► Ad ogni Puzzle Mega connessa al punto di alimentazione elettrica possono esserne collegate altre 4. Ad ognuna di queste possono esserne collegate fino ad altre 3 e così via. Le lampade totali collegabili su un singolo punto di alimentazione sono 36.

Puzzle Mega, design by Studio Italia Design, 2019

Wall lamp Ceiling lamp

Puzzle Mega rectangular

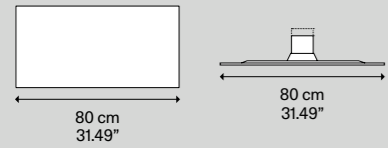
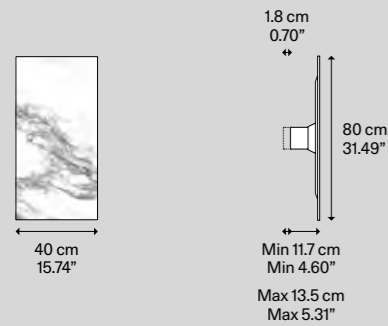

Light source
Sorgente luminosa

LED
↘ 2700 K
↘ 4 x 16 W/6800 lm
↘ 220-240 V
↘ CRI 92
↘ MacAdam 3-Step

or

LED
↘ 3000 K
↘ 4 x 16 W/7200 lm
↘ 220-240 V
↘ CRI 92
↘ MacAdam 3-Step

LED included
LED incluso

Metal structure
Montatura in metallo

Matte White - 9016
Bianco Opaco - 9016

Matte White - 9016
Bianco Opaco - 9016

Fine Porcelain Stoneware diffuser
Diffusore in Gres Porcellanato

Renoir
by Infinity™

Renoir
by Infinity™

Code
Codice

167009

167010

Net weight/Peso netto: 7.9 kg Pack/Colli: 2

CE IP20 Energy Saving Dim Triac EAC

Puzzle Mega rectangular

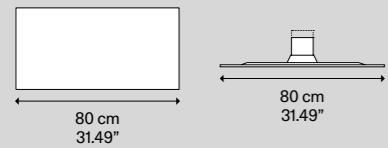
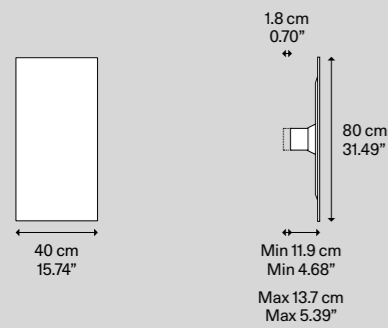

Light source
Sorgente luminosa

LED
↘ 2700 K
↘ 4 x 16 W/6800 lm
↘ 220-240 V
↘ CRI 92
↘ MacAdam 3-Step

or

LED
↘ 3000 K
↘ 4 x 16 W/7200 lm
↘ 220-240 V
↘ CRI 92
↘ MacAdam 3-Step

LED included
LED incluso

Metal structure
Montatura in metallo

Matte White - 9016
Bianco Opaco - 9016

Matte White - 9016
Bianco Opaco - 9016

MDF diffuser
Diffusore in MDF

Matte White - 9016
Bianco Opaco - 9016

Matte White - 9016
Bianco Opaco - 9016

Code
Codice

167019

167020

Net weight/Peso netto: 5 kg Pack/Colli: 2

CE IP20 Energy Saving Dim Triac EAC

► LED sources with direct power supply to the AC line voltage - driver not required. Dimmable with phase cut dimmer.
► You can connect up to 4 Puzzle Mega to each fixture directly connected to the power supply. You can also connect up to 3 additional fixtures to each of those for maximum total of 36 fixtures on a single power outlet.

► LED con alimentazione diretta a tensione di rete - non necessita di driver. Dimmerabile con varialuce a taglio di fase.
► Ad ogni Puzzle Mega connessa al punto di alimentazione elettrica possono esserne collegate altre 4. Ad ognuna di queste possono esserne collegate fino ad altre 3 e così via. Le lampade totali collegabili su un singolo punto di alimentazione sono 36.

Puzzle Mega, design by Studio Italia Design, 2019

Accessory

Puzzle Mega extension

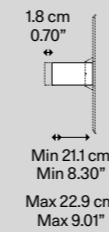

Net weight/Peso netto: 0.86 kg Pack/Colli: 1

Description
Descrizione

Extension optional
Estensione opzionale

To be used to widen the light beam in case of ceiling installation

Da utilizzare per ampliare il fascio luminoso in caso di installazione a soffitto

Metal structure
Montatura in metallo

Matte White - 9016
Bianco Opaco - 9016

Code
Codice

167099

CE IP40

Accessory connector



Description
Descrizione

Connection
Collegamento

To be used to connect the fixtures together in the compositions

Da utilizzare per collegare le lampade tra loro nelle composizioni

Code
Codice

167100

Net weight/Peso netto: 0.10 kg Pack/Colli: 1

CE IP40

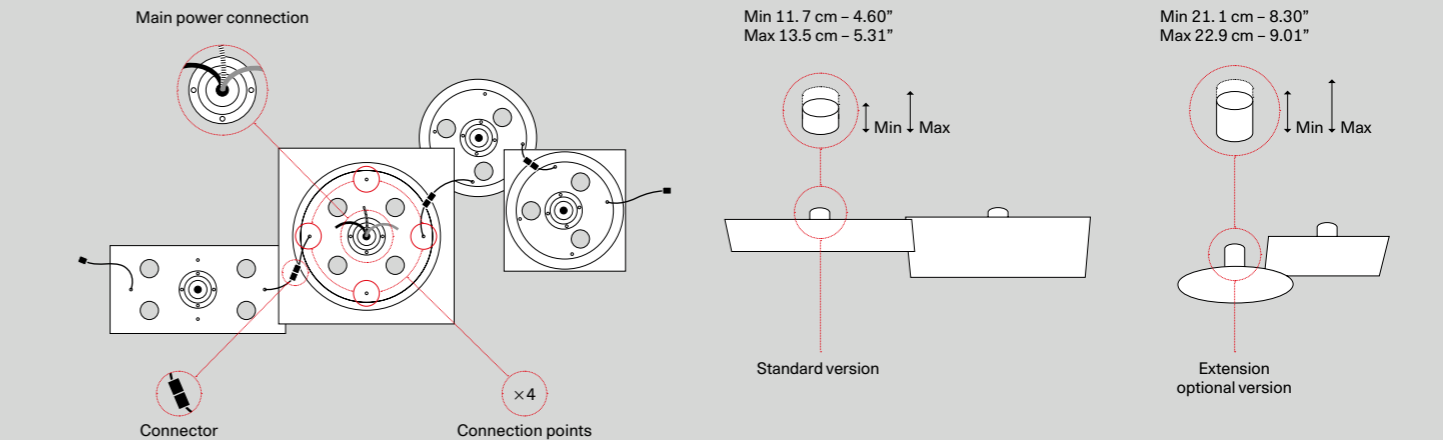

► LED sources with direct power supply to the AC line voltage - driver not required. Dimmable with phase cut dimmer.
► You can connect up to 4 Puzzle Mega to each fixture directly connected to the power supply. You can also connect up to 3 additional fixtures to each of those for maximum total of 36 fixtures on a single power outlet.

► LED con alimentazione diretta a tensione di rete - non necessita di driver. Dimmerabile con varialuce a taglio di fase.
► Ad ogni Puzzle Mega connessa al punto di alimentazione elettrica possono esserne collegate altre 4. Ad ognuna di queste possono esserne collegate fino ad altre 3 e così via. Le lampade totali collegabili su un singolo punto di alimentazione sono 36.

Puzzle, Puzzle Twist

Essential forms in metal, square and rectangular, which seem to disappear in the ceiling or wall. A clear-cut geometry that plays on the effect of overlapping square shapes: thanks to its two swivel joints, Puzzle Twist can be adjusted at will to create suggestive plays of light on the walls and ceilings, making for a truly personalised atmosphere. With Puzzle lamps, light becomes the feature element of living spaces, creating soft, geometric effects.

Forme essenziali in metallo, quadrati e rettangoli che sembrano scomparire nel soffitto o nella parete. Una geometria rigorosa che gioca con un effetto di sovrapposizioni di forme quadrate: con i giunti flessibili di cui è dotata, Puzzle Twist può essere regolata a piacimento per creare suggestivi giochi di luce su pareti e soffitti rendendo l'atmosfera del tutto personale. Le lampade Puzzle rendono la luce il vero ornamento degli ambienti abitativi creando effetti di morbide geometrie.

Wall lamp, Ceiling lamp

Puzzle single square,
FINISH Matte Black

Puzzle, *design by* Studio Italia Design, 2014

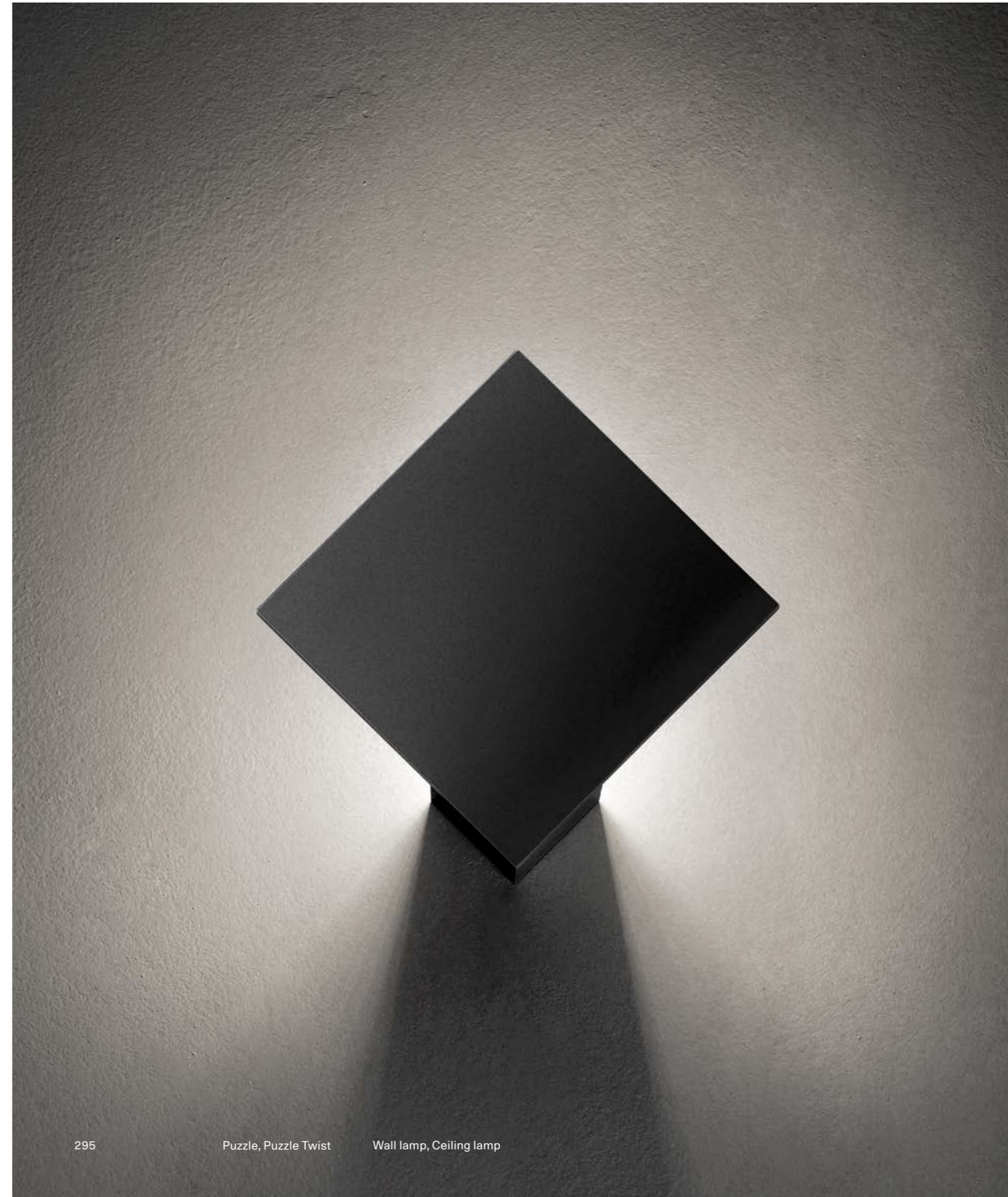



Puzzle double square,
FINISH Matte Black

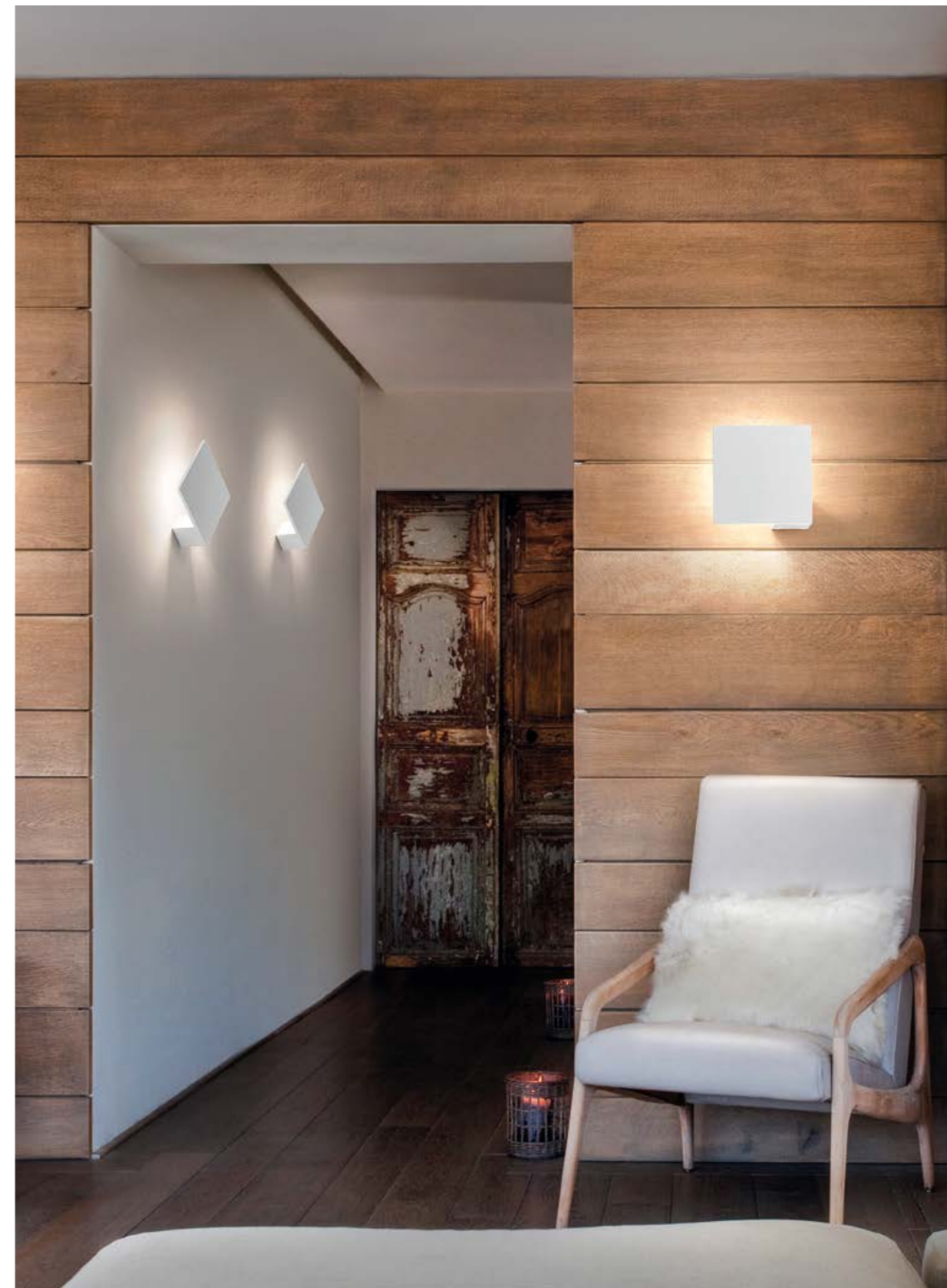

Puzzle single square, FINISH Matte White



Puzzle square & rectangle, FINISH Matte White



Puzzle double square, FINISH Matte White

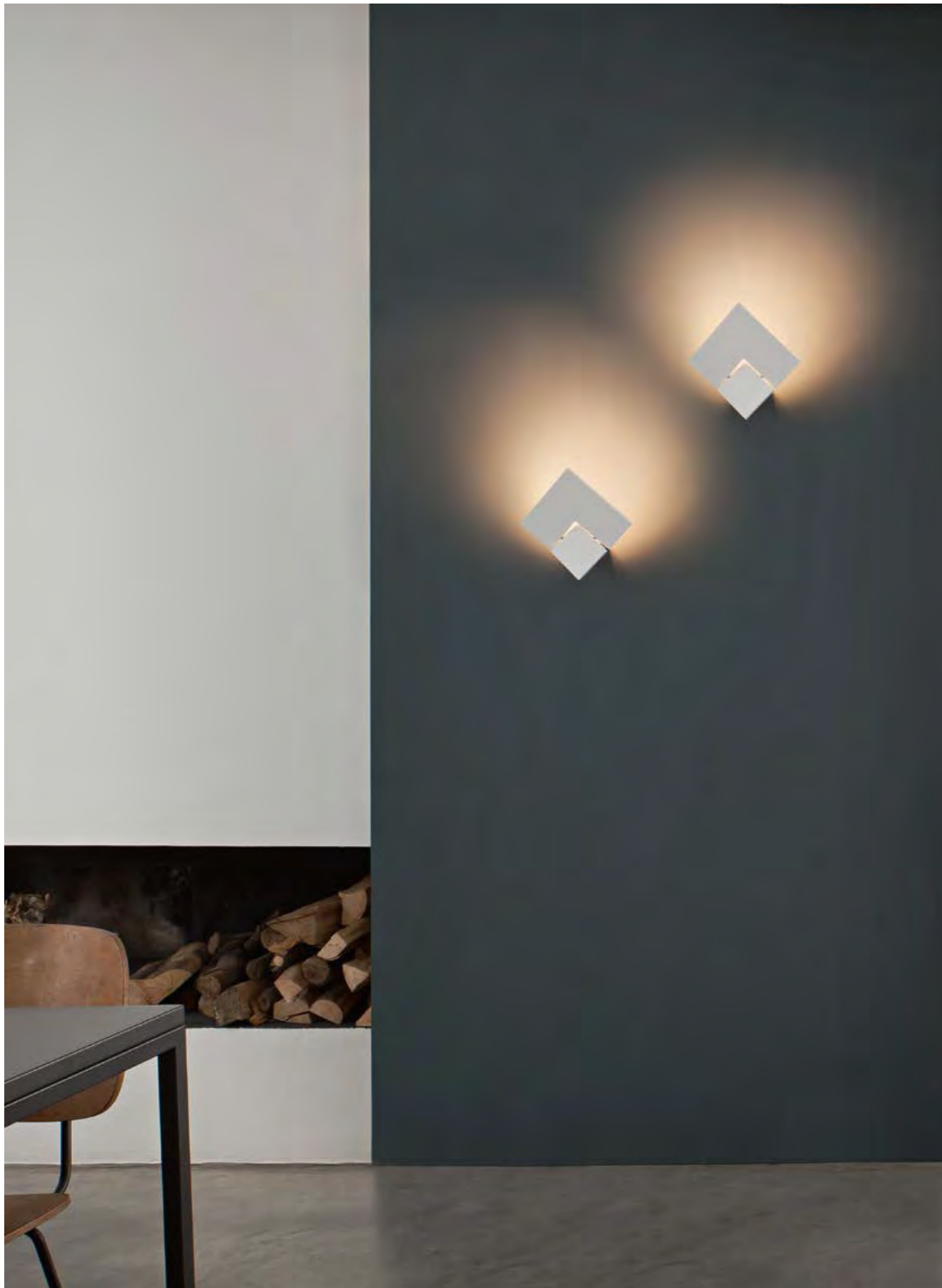

Puzzle Twist, FINISH Matte White

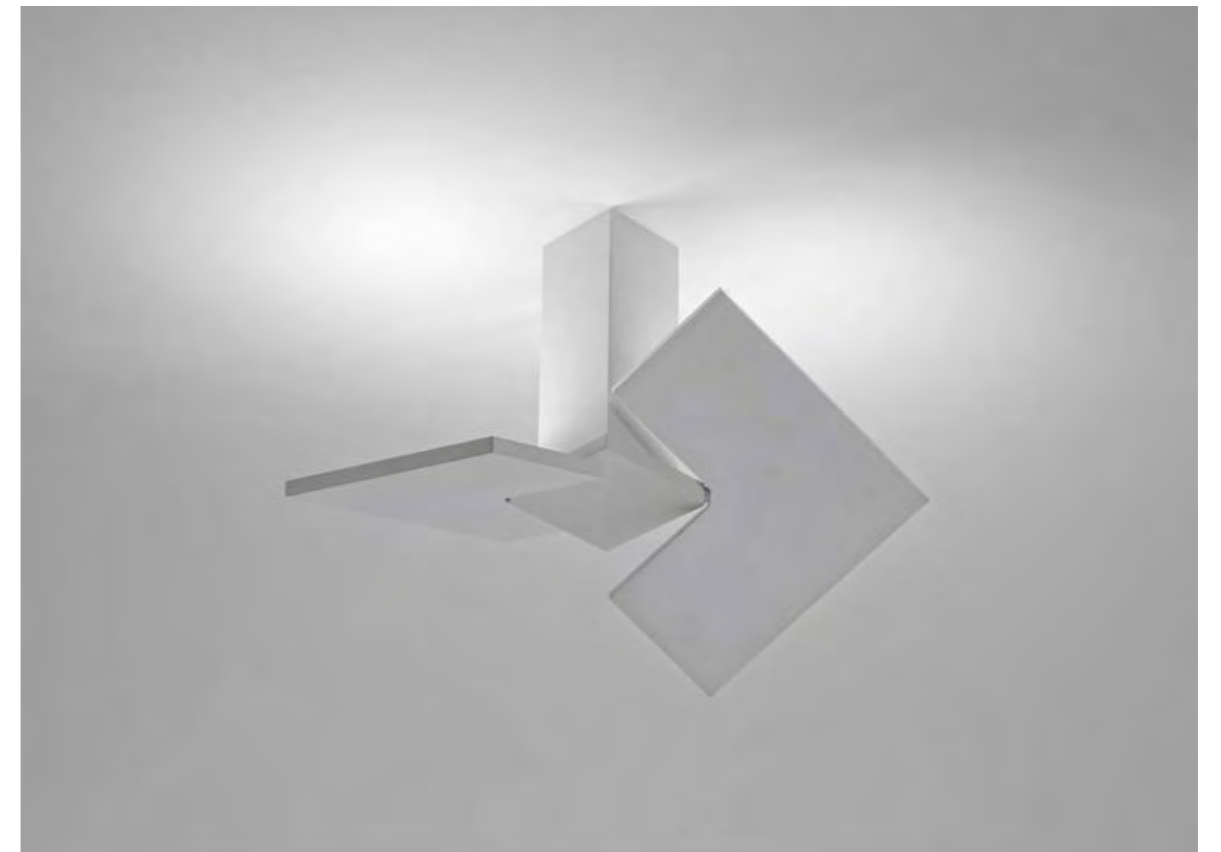

Puzzle Twist, FINISH Matte White

Formes essentielles en métal, carrées et rectangulaires qui semblent disparaître dans le plafond ou le mur. Une géométrie rigoureuse qui joue avec un effet de superposition de forme carrée : avec ses joints flexibles, Puzzle Twist peut être réglé à volonté pour créer des jeux de lumières suggestifs sur les murs et plafonds pour créer une atmosphère personnelle. Les lampes Puzzle font de la lumière une décoration des espaces de vie et créent des effets géométriques harmonieux. ● FR

Einfache Formen aus Metall, quadratisch und rechteckig, die in der Decke oder in der Wand zu verschwinden scheinen. Eine strenge geometrische Form, die mit einem Effekt aus Überlagerungen in quadratischer Form spielt: dank der flexiblen Gelenke, mit der die Leuchte ausgestattet ist, kann Puzzle Twist nach Belieben eingestellt werden, um wunderbare Lichtspiele an Wänden und Decken entstehen zu lassen, um die Atmosphäre vollkommen persönlich zu gestalten. Die Leuchten Puzzle machen das Licht zum wahren Ornament von Wohnräumen und lassen Effekte mit weicher geometrischer Form entstehen. ● DE

Formas esenciales de metal, cuadrados y rectángulos que parecen desaparecer en el techo o la pared. Una rigurosa geometría que juega con un efecto de superposición de formas cuadradas: con sus articulaciones flexibles, Puzzle Twist puede ajustarse a voluntad para crear sugestivos efectos de luz en paredes y techos haciendo que la atmósfera sea completamente personal. Las lámparas Puzzle hacen que la luz sea el verdadero ornamento de los espacios habitables, creando efectos de geometrías suaves. ● ES

Простые формы из металла, квадраты и прямоугольники, которые как бы исчезают в потолке или стене. Строгая геометрия, обыгрывающая эффект перекрывающихся квадратных форм: благодаря гибким соединительным элементам, которыми оснащен светильник Puzzle Twist, его можно отрегулировать по своему вкусу, создавая живописную игру света на стенах и потолках и полностью персонализируя атмосферу. Светильники Puzzle превращают свет в истинный декоративный элемент жилых интерьеров, создавая мягкие геометрические эффекты. ● RU

基本的金属形状，是似乎在吸顶灯和壁灯中消失的正方形和矩形。严格的几何形状，具有重叠的方形效果：借助其灵活的接头，Puzzle Twist可以随意调节，在墙壁和天花板上营造出暗示性的光线，使氛围完全个性化。Puzzle灯通过创造柔和的几何效果，使照明成为生活空间的真正装饰品。● ZH

Puzzle single square ↘ Wall lamp

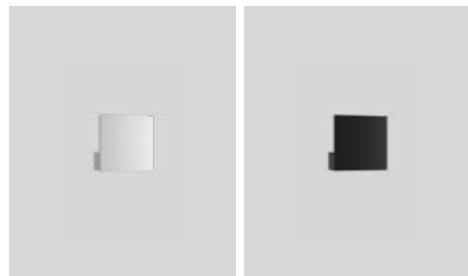

Puzzle single square ↘ Ceiling lamp

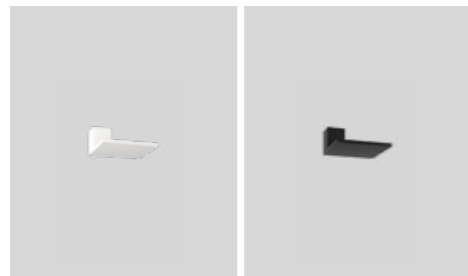

Puzzle Twist ↘ Wall lamp



Puzzle double square ↘ Wall lamp

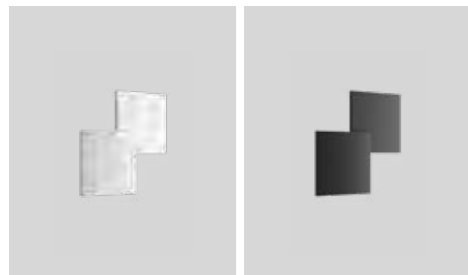

Puzzle double square ↘ Ceiling lamp

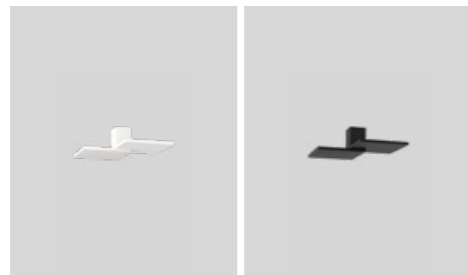

Puzzle Twist ↘ Ceiling lamp



Puzzle square & rectangle ↘ Wall lamp

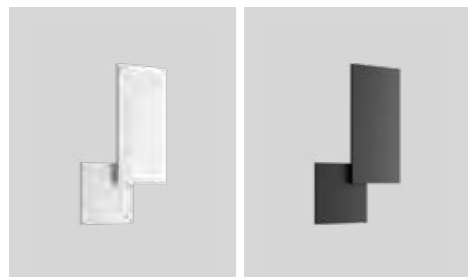

Puzzle square & rectangle ↘ Ceiling lamp

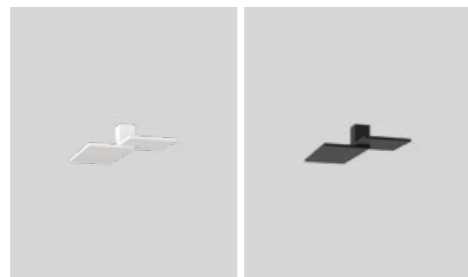

Puzzle double rectangle ↘ Wall lamp

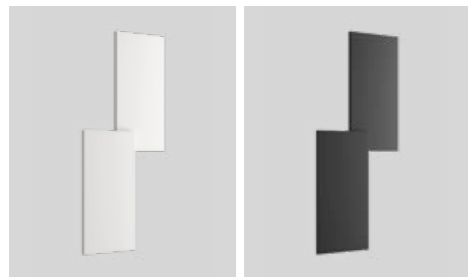

Puzzle double rectangle ↘ Ceiling lamp

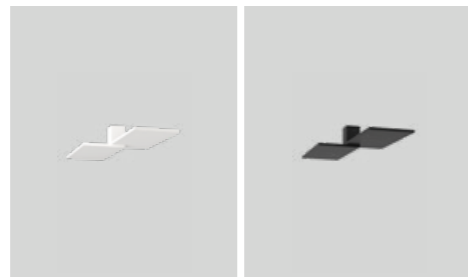

Puzzle, design by Studio Italia Design, 2014

Wall lamp

Ceiling lamp

Puzzle single square

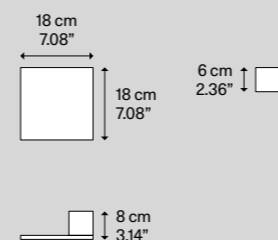

Light source
Sorgente luminosa

LED
↘ 2700 K
↘ 16 W / 1700 lm
↘ 220-240 V
↘ CRI 92
↘ MacAdam 3-Step

Metal structure
Montatura in metallo

Matte White – 9016
Bianco Opaco – 9016

Code
Codice

146008

Matte Black – 9005
Nero Opaco – 9005

146030

Matte White – 9016
Bianco Opaco – 9016

146004

Matte Black – 9005
Nero Opaco – 9005

146031

LED included
LED incluso

Net weight / Peso netto: 1.16 kg

Pack / Colli: 1

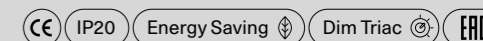

Puzzle double square

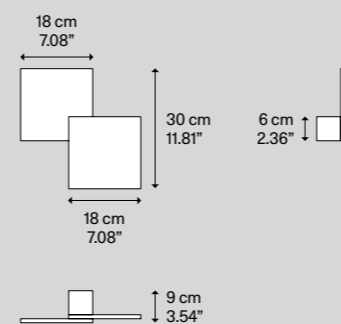

LED
↘ 2700 K
↘ 2 × 16 W / 3400 lm
↘ 220-240 V
↘ CRI 92
↘ MacAdam 3-Step

Matte White – 9016
Bianco Opaco – 9016

146007

Matte Black – 9005
Nero Opaco – 9005

146032

Matte White – 9016
Bianco Opaco – 9016

146003

Matte Black – 9005
Nero Opaco – 9005

146033

LED included
LED incluso

Net weight / Peso netto: 2 kg

Pack / Colli: 1

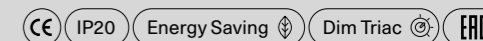

► LED sources with direct power supply to the AC line voltage – driver not required.
Dimmable with phase cut dimmer.
► Optional backplate available.

► LED con alimentazione diretta a tensione di rete – non necessita di driver.
Dimmerabile con varialuce a taglio di fase.
► Disponibile piastra a muro opzionale.

Puzzle, design by Studio Italia Design, 2014

Wall lamp Ceiling lamp

Puzzle square & rectangle

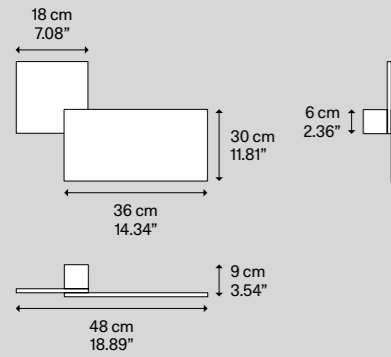

Light source Sorgente luminosa

LED
 ↘ 2700 K
 ↘ 2 × 16 W/3400 lm
 ↘ 220–240 V
 ↘ CRI 92
 ↘ MacAdam 3–Step

or

LED
 ↘ 3000 K
 ↘ 2 × 16 W/3600 lm
 ↘ 220–240 V
 ↘ CRI 92
 ↘ MacAdam 3–Step

LED included
 LED incluso

Metal structure Montatura in metallo

● Matte White – 9016
 Bianco Opaco – 9016

● Matte Black – 9005
 Nero Opaco – 9005

● Matte White – 9016
 Bianco Opaco – 9016

● Matte Black – 9005
 Nero Opaco – 9005

Code Codice

146006

146034

146002

146035

Net weight/Peso netto: 2.91 kg

Pack/Colli: 1

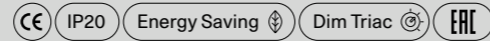

Puzzle double rectangle

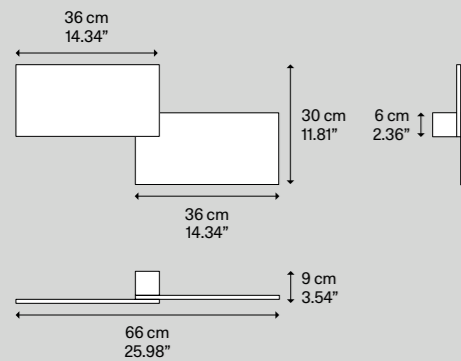

LED
 ↘ 2700 K
 ↘ 2 × 16 W/3400 lm
 ↘ 220–240 V
 ↘ CRI 92
 ↘ MacAdam 3–Step

or

LED
 ↘ 3000 K
 ↘ 2 × 16 W/3600 lm
 ↘ 220–240 V
 ↘ CRI 92
 ↘ MacAdam 3–Step

LED included
 LED incluso

● Matte White – 9016
 Bianco Opaco – 9016

● Matte Black – 9005
 Nero Opaco – 9005

● Matte White – 9016
 Bianco Opaco – 9016

● Matte Black – 9005
 Nero Opaco – 9005

146005

146036

146001

146037

Net weight/Peso netto: 3.69 kg

Pack/Colli: 1

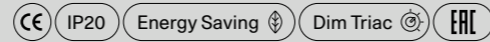

► LED sources with direct power supply to the AC line voltage – driver not required. Dimmable with phase cut dimmer.
 ► Optional backplate available.

► LED con alimentazione diretta a tensione di rete – non necessita di driver. Dimmerabile con varialuce a taglio di fase.
 ► Disponibile piastra a muro opzionale.

Puzzle Twist, design by Studio Italia Design, 2014

Wall lamp

Puzzle Twist

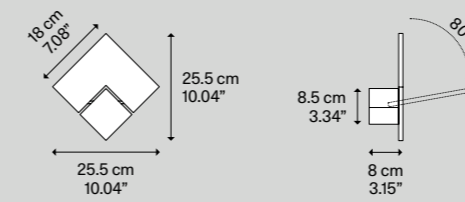

Light source Sorgente luminosa

LED
 ↘ 2700 K
 ↘ 16 W/1700 lm
 ↘ 210–250 V
 ↘ CRI 92
 ↘ MacAdam 3–Step

or

LED
 ↘ 3000 K
 ↘ 16 W/1800 lm
 ↘ 210–250 V
 ↘ CRI 92
 ↘ MacAdam 3–Step

LED included
 LED incluso

Metal structure Montatura in metallo

● Matte White – 9016
 Bianco Opaco – 9016

● Matte White – 9016
 Bianco Opaco – 9016

Code Codice

146009

146010

Net weight/Peso netto: 0.88 kg

Pack/Colli: 1

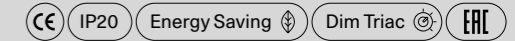

Ceiling lamp

Puzzle Twist

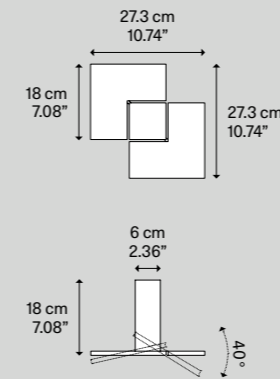

LED
 ↘ 2700 K
 ↘ 2 × 16 W/3400 lm
 ↘ 210–250 V
 ↘ CRI 92
 ↘ MacAdam 3–Step

or

LED
 ↘ 3000 K
 ↘ 2 × 16 W/3600 lm
 ↘ 210–250 V
 ↘ CRI 92
 ↘ MacAdam 3–Step

LED included
 LED incluso

● Matte White – 9016
 Bianco Opaco – 9016

● Matte White – 9016
 Bianco Opaco – 9016

146011

146012

Net weight/Peso netto: 2.47 kg

Pack/Colli: 1

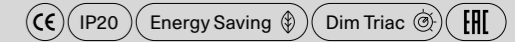

► LED sources with direct power supply to the AC line voltage – driver not required. Dimmable with phase cut dimmer.
 ► Optional backplate available.

► LED con alimentazione diretta a tensione di rete – non necessita di driver. Dimmerabile con varialuce a taglio di fase.
 ► Disponibile piastra a muro opzionale.

Puzzle Round

With its soft shapes, flexible joints and LED light source, Puzzle Round can be adjusted at will to create striking light effects on walls and ceilings. The unobtrusive aesthetics and the three available finishes make it perfect for the most varied living contexts.

Con le sue forme morbide, i giunti flessibili e la sorgente luminosa a LED, Puzzle Round può essere regolata a piacimento per creare suggestivi giochi di luce su pareti e soffitti. L'estetica discreta e le tre finiture disponibili la rendono perfetta per i più svariati contesti abitativi.

Wall lamp, Ceiling lamp

Puzzle Round double,
FINISH Matte White

Puzzle Round, *design by* Studio Italia Design, 2016



Puzzle Round single and double,
FINISH Coppery Bronze





1



2

1, 2–Puzzle Round single,
FINISH Matte White

Puzzle Round double,
FINISH Matte Black



311

Puzzle Round

Wall lamp, Ceiling lamp

Puzzle Round single,
FINISH Coppery Bronze



Avec ses formes souples, les joints flexibles et la source lumineuse à LED, Puzzle Round peut être réglée à discrétion pour créer des jeux de lumière suggestifs sur les murs et les plafonds. Son esthétique discrète et les trois finitions disponibles la rendent parfaite pour des contextes de vie variés. ● FR

Durch ihre weichen Formen, die flexiblen Gelenke und die LED-Lichtquelle kann Puzzle Round nach Belieben eingestellt werden, um wunderbare Lichtspiele an Wänden und Decken entstehen zu lassen. Die unauffällige Ästhetik und die drei verfügbaren Ausführungen machen die Leuchte perfekt für verschiedene Wohnbereiche. ● DE

Con sus formas suaves, articulaciones flexibles y fuente de luz LED, Puzzle Round puede ajustarse a voluntad para crear sorprendentes efectos de luz en paredes y techos. La estética discreta y los tres acabados disponibles lo hacen perfecto para una amplia variedad de entornos. ● ES

Благодаря своим мягким формам, гибким соединительным элементам и источнику света LED, светильник Puzzle Round можно регулировать по желанию для создания эффектной игры света на стенах и потолках. Неброский дизайн и три доступных варианта отделки делают его идеальным для разных жилых контекстов. ● RU

柔软的外形，灵活的接头和LED光源，Puzzle Round可以根据需要进行调整，以在墙壁和天花板上营造出光线的暗示性。谨慎的美学设计和三种可用的颜色，使其非常适合各种房屋环境。● ZH

Puzzle Round single » Wall lamp

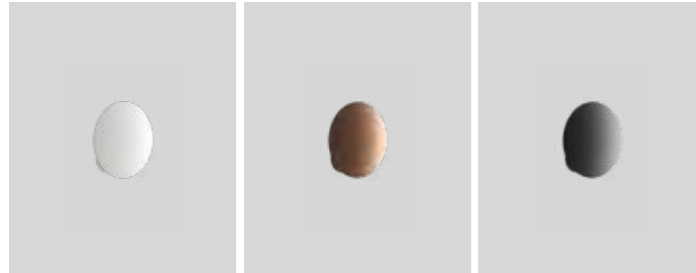

Puzzle Round single » Ceiling lamp

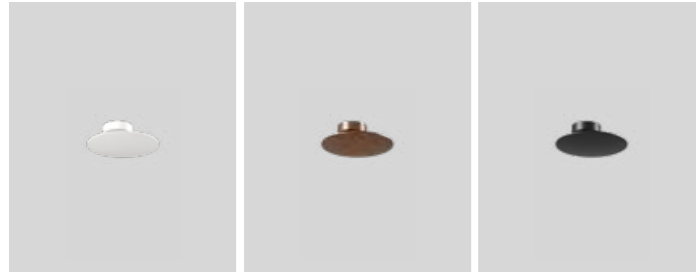

Puzzle Round double » Wall lamp

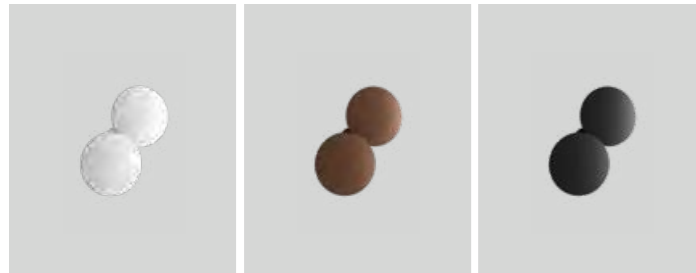

Puzzle Round double » Ceiling lamp

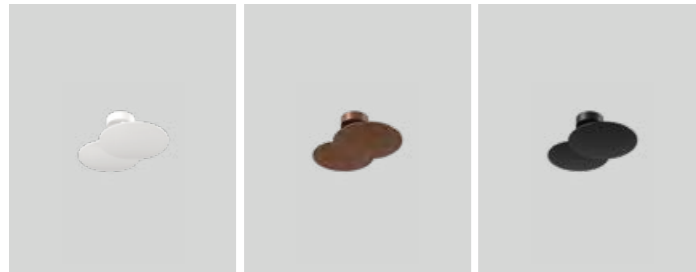

Puzzle Round, design by Studio Italia Design, 2016

Wall lamp

Ceiling lamp

Puzzle Round single

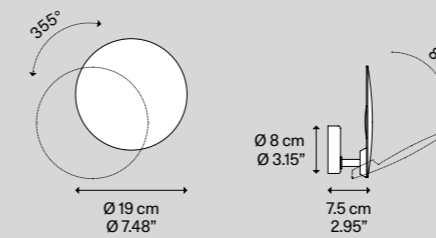

Light source
Sorgente luminosa

LED
 ↳ 2700 K
 ↳ 16 W/1700 lm
 ↳ 220-240 V
 ↳ CRI 92
 ↳ MacAdam 3-Step

or

LED
 ↳ 3000 K
 ↳ 16 W/1800 lm
 ↳ 220-240 V
 ↳ CRI 92
 ↳ MacAdam 3-Step

LED included
LED incluso



Adjustable light
Luce orientabile

Net weight/Peso netto: 0.6 kg

Pack/Colli: 1

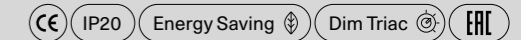

Puzzle Round double

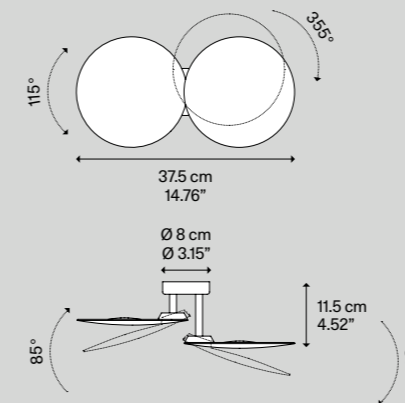

LED
 ↳ 2700 K
 ↳ 2 x 16 W/3400 lm
 ↳ 220-240 V
 ↳ CRI 92
 ↳ MacAdam 3-Step

or

LED
 ↳ 3000 K
 ↳ 2 x 16 W/3600 lm
 ↳ 220-240 V
 ↳ CRI 92
 ↳ MacAdam 3-Step

LED included
LED incluso



Adjustable light
Luce orientabile

Net weight/Peso netto: 1.1 kg

Pack/Colli: 1

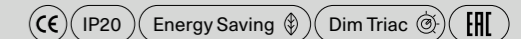

Puzzle Outdoor

Puzzle Outdoor is a collection designed to enhance the outdoor spaces of homes and buildings, from the façade to the terrace, making them pleasant and comfortable at any time of day. Discrete by day, adaptable to any type of architecture, these lamps featured in essential shapes light up suggestive atmospheres after sundown.

Puzzle Outdoor è una collezione progettata per valorizzare gli spazi esterni di abitazioni ed edifici, dalla facciata alla terrazza, e renderli piacevoli e confortevoli in ogni momento della giornata. Discrete di giorno, adatte ad ogni tipo di architettura, queste lampade dalle geometrie essenziali accendono atmosfere suggestive dopo il tramonto.

Wall lamp

Puzzle Outdoor double rectangle,
FINISH Matte White

Puzzle Outdoor, *design by* Studio Italia Design, 2019





Puzzle Outdoor single square and square & rectangle, FINISH Anthracite Black

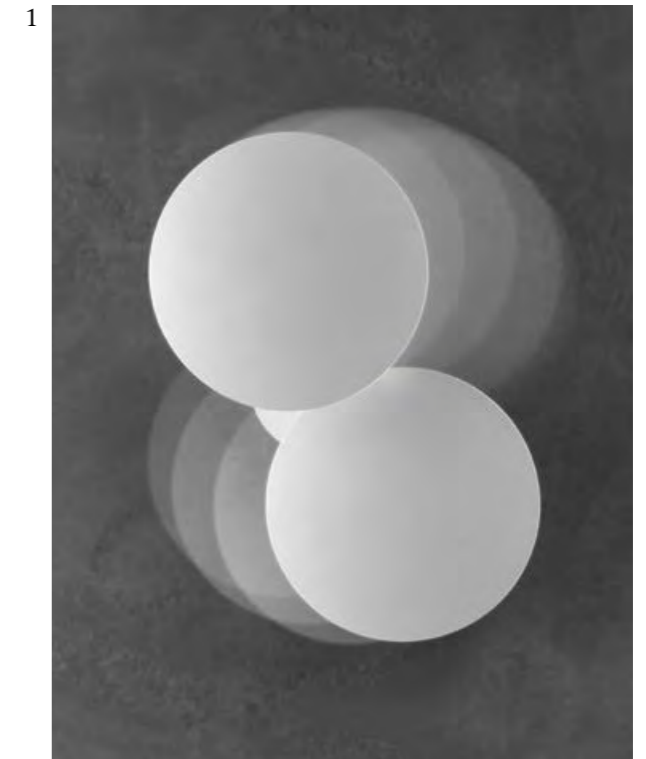

1–Puzzle Outdoor round double,
FINISH Matte White

2–Puzzle Outdoor round single,
FINISH Matte White

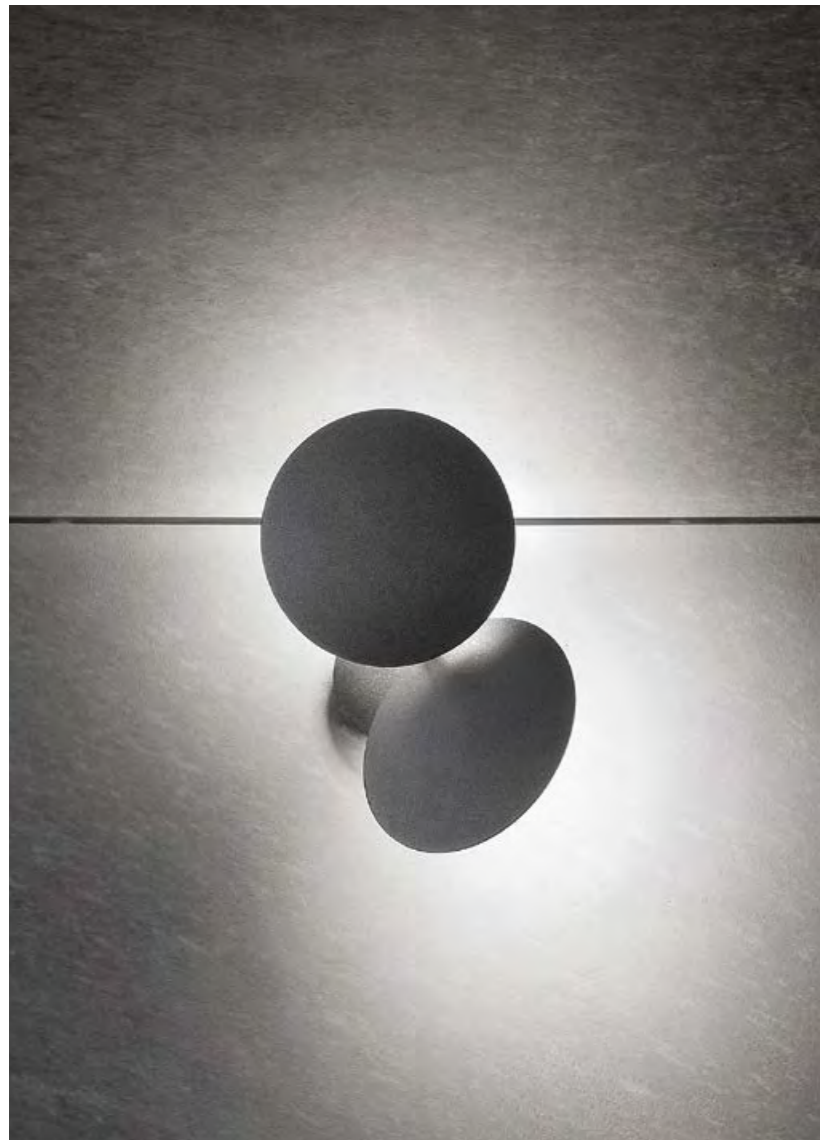

Puzzle Outdoor round double,
FINISH Anthracite Black

Puzzle Outdoor est une collection conçue pour valoriser les espaces extérieurs des habitations et des bâtiments, de la façade à la terrasse, et les rendre plaisants et confortables à tout moment de la journée. Discret le jour, adapté à tout type d'architecture, ces luminaires aux géométries essentielles offrent une atmosphère suggestive après le coucher du soleil. ● FR

Puzzle Outdoor ist eine Kollektion, die entworfen wurde, um Außenräumen von Wohn- und öffentlichen Gebäuden von der Fassade bis hin zur Terrasse in Szene zu setzen und zu jeder Tageszeit angenehm und wohlig zu machen. Tagsüber diskret und für jeden Architekturstil geeignet, lassen diese Leuchten mit einfacher Form nach dem Sonnenuntergang wunderbare Atmosphären entstehen. ● DE

Puzzle Outdoor es una colección diseñada para realizar los espacios exteriores de las casas y edificios, desde la fachada hasta la terraza, y hacerlos agradables y cómodos a cualquier hora del día. Discretas durante el día, adecuadas para todo tipo de arquitectura, estas lámparas de geometría esencial iluminan sugestivas atmósferas después del atardecer. ● ES

Puzzle Outdoor – это коллекция, разработанная для оформления и освещения наружных пространств домов и зданий, от фасада до террасы, чтобы сделать их привлекательными и комфортными в любое время суток. Неброские в дневное время, подходящие для любого типа архитектуры, после захода солнца эти светильники с простым геометрическим дизайном освещают и создают восхитительную атмосферу. ● RU

Puzzle Outdoor系列旨在改善房屋和建筑物的户外空间，从外墙到露台，使其在一天中的任何时候都舒适宜人。白天不太显眼，适合任何类型的建筑，该款灯具具有基本的几何形状，在日落之后会散发出令人愉悦的气氛。● ZH

Puzzle Outdoor single square ▾ Wall lamp

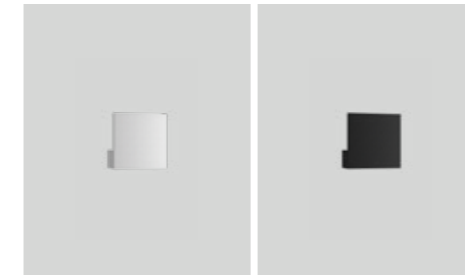

Puzzle Outdoor round single ▾ Wall lamp

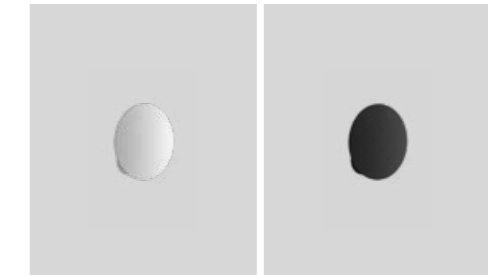

Puzzle Outdoor double square ▾ Wall lamp

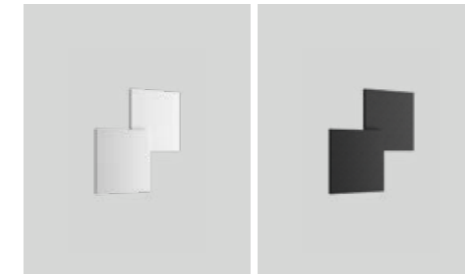

Puzzle Outdoor round double ▾ Wall lamp

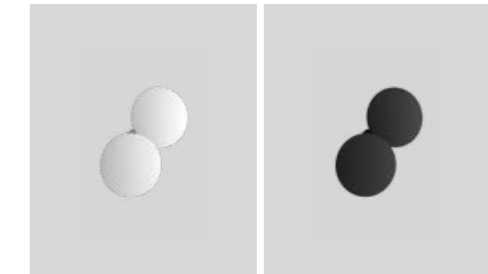

Puzzle Outdoor square & rectangle ▾ Wall lamp

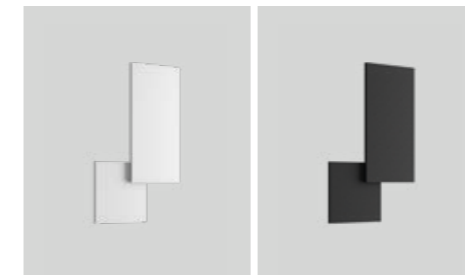

Puzzle Outdoor double rectangle ▾ Wall lamp

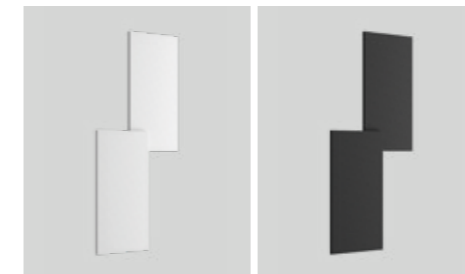

Puzzle Outdoor, design by Studio Italia Design, 2019

Wall lamp

Puzzle Outdoor single square

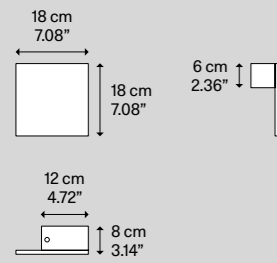

Light source
Sorgente luminosa

LED
 ↗ 3000 K
 ↗ 16 W/1700 lm
 ↗ 220-240 V
 ↗ CRI 92
 ↗ MacAdam 3-Step

Metal structure
Montatura in metallo

● Matte White - 9016
Bianco Opaco - 9016

● Anthracite Black
Nero Antracite

Code
Codice

146024

146029

LED included
LED incluso

Net weight/Peso netto: 1.34 kg Pack/Colli: 1

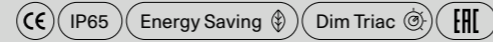

Puzzle Outdoor double square

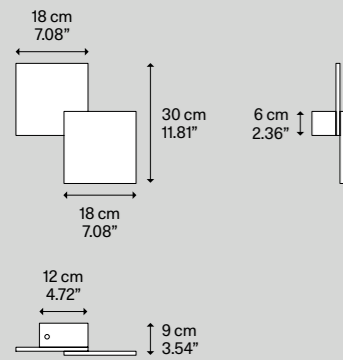

LED
 ↗ 3000 K
 ↗ 2 x 16 W/3400 lm
 ↗ 220-240 V
 ↗ CRI 92
 ↗ MacAdam 3-Step

● Matte White - 9016
Bianco Opaco - 9016

● Anthracite Black
Nero Antracite

146023

146028

LED included
LED incluso

Net weight/Peso netto: 2.27 kg Pack/Colli: 1

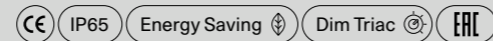

Puzzle Outdoor square & rectangle

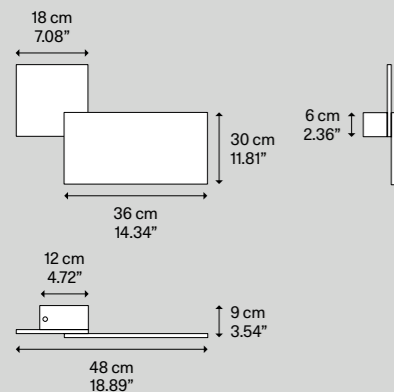

LED
 ↗ 3000 K
 ↗ 2 x 16 W/3400 lm
 ↗ 220-240 V
 ↗ CRI 92
 ↗ MacAdam 3-Step

● Matte White - 9016
Bianco Opaco - 9016

● Anthracite Black
Nero Antracite

146022

146027

LED included
LED incluso

Net weight/Peso netto: 3.24 kg Pack/Colli: 1

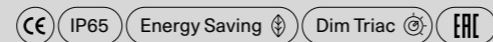

LED sources with direct power supply to the AC line voltage - driver not required. Dimmable with phase cut dimmer.

LED con alimentazione diretta a tensione di rete - non necessita di driver. Dimmerabile con varialuce a taglio di fase.

Puzzle Outdoor, design by Studio Italia Design, 2019

Wall lamp

Puzzle Outdoor double rectangle

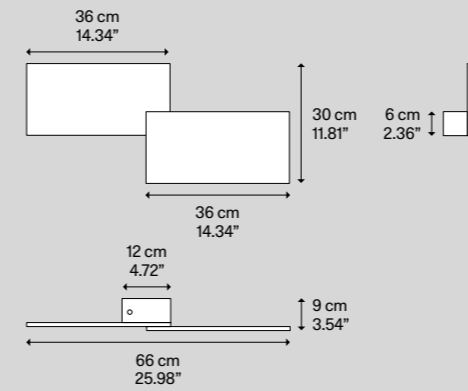

Light source
Sorgente luminosa

LED
 ↗ 3000 K
 ↗ 2 x 16 W/3400 lm
 ↗ 220-240 V
 ↗ CRI 92
 ↗ MacAdam 3-Step

Metal structure
Montatura in metallo

● Matte White - 9016
Bianco Opaco - 9016

● Anthracite Black
Nero Antracite

Code
Codice

146021

146020

LED included
LED incluso

Net weight/Peso netto: 4.47 kg Pack/Colli: 1

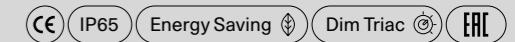

Puzzle Outdoor round single

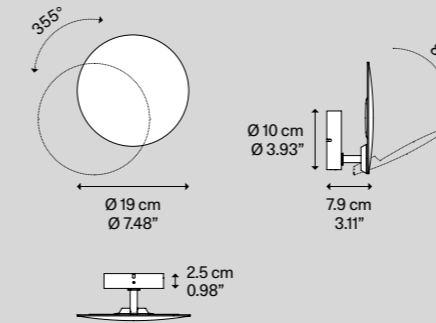

LED
 ↗ 3000 K
 ↗ 16 W/1700 lm
 ↗ 220-240 V
 ↗ CRI 92
 ↗ MacAdam 3-Step

● Matte White - 9016
Bianco Opaco - 9016

● Anthracite Black
Nero Antracite

159022

159020

LED included
LED incluso



Adjustable light
Luce orientabile

Net weight/Peso netto: 0.72 kg Pack/Colli: 1

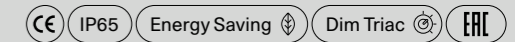

Puzzle Outdoor round double

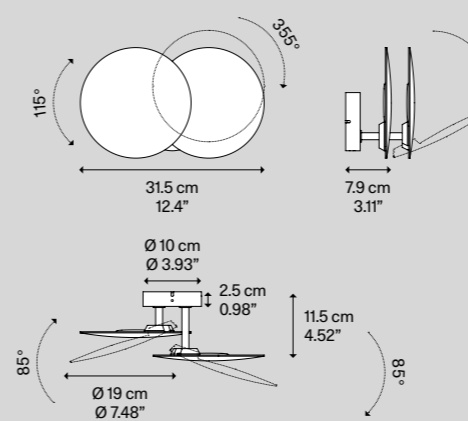

LED
 ↗ 3000 K
 ↗ 2 x 16 W/3400 lm
 ↗ 220-240 V
 ↗ CRI 92
 ↗ MacAdam 3-Step

● Matte White - 9016
Bianco Opaco - 9016

● Anthracite Black
Nero Antracite

159024

159029

LED included
LED incluso



Adjustable light
Luce orientabile

Net weight/Peso netto: 1.30 kg Pack/Colli: 1

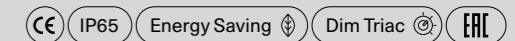

LED sources with direct power supply to the AC line voltage - driver not required. Dimmable with phase cut dimmer.

LED con alimentazione diretta a tensione di rete - non necessita di driver. Dimmerabile con varialuce a taglio di fase.

Valentina

Valentina is a family of lamps characterised by a transparent methacrylate lampshade diffuser embellished by special prismatic workmanship designed to amplify the light. Available in a suspension, wall and table version, Valentina lamps are perfect for infusing spaces with a soft and romantic atmosphere.

Valentina è una famiglia di lampade caratterizzate da un diffusore a cappello in metacrilato trasparente impreziosito dalla particolare lavorazione prismatica che ne amplifica la luminosità. A sospensione, a parete e da tavolo, le lampade Valentina sono ideali per infondere agli ambienti un'atmosfera morbida e romantica.

Cluster suspension lamp, Wall lamp,
Table lamp, Cordless table lamp

Valentina, *design by* Andrea Toso, 2018



Valentina,
FINISH Clear

Valentina, Rectangular Cluster System,
composition of 14 lights, FINISH Clear





Valentina, FINISH Clear



Valentina, special composition, FINISH Clear



Valentina cordless table, FINISH Polished Gold



Valentina cordless table, FINISHES Polished White, Polished Black, Polished Chrome, Polished Gold and Polished Rose Gold

Valentina, FINISH Clear



Valentina est une famille de luminaires caractérisés par un diffuseur en acrylique transparent enrichi par un traitement prismatique spécifique qui intensifie sa luminosité. Suspensions, appliques et lampes sur table, les lampes Valentina sont parfaites pour introduire dans l'environnement une atmosphère douce et romantique. ●FR

Valentina ist eine Leuchtenfamilie, gekennzeichnet durch einen hutförmigen Diffusor aus transparentem Methacrylat, der durch die besondere Verarbeitung in Prismenform aufgewertet wird und mehr Licht spendet. Als Hänge-, Wand- oder Tischleuchte, ist die Serie Valentina ideal, um Räumen eine wohlige und romantische Atmosphäre zu verleihen. ●DE

Valentina es una familia de lámparas caracterizada por un difusor de tapa de metacrilato transparente embellecido por el particular procesamiento prismático que amplifica el brillo. Lámparas colgantes, de pared y de sobremesa, las lámparas Valentina son ideales para infundir a las estancias un ambiente suave y romántica. ●ES

Valentina – это семейство светильников, характеризующихся купольным диффузором из прозрачного метакрилата, украшенного особым призматическим рифлением, усиливающим яркость. Подвесные, настенные и настольные светильники Valentina идеально подходят для создания в интерьерах мягкой романтической атмосферы. ●RU

Valentina是一款家族系列的灯具，其特征在于透明的聚甲基丙烯酸酯帽式灯罩，通过特殊的棱柱加工点缀其上，以放大其亮度。Valentina灯具具有悬吊式，壁式和台灯，非常适合将柔和浪漫的气氛注入房间。●ZH

Valentina ▾ Cluster suspension lamp



Valentina ▾ Wall lamp



Valentina ▾ Table lamp and Cordless table lamp

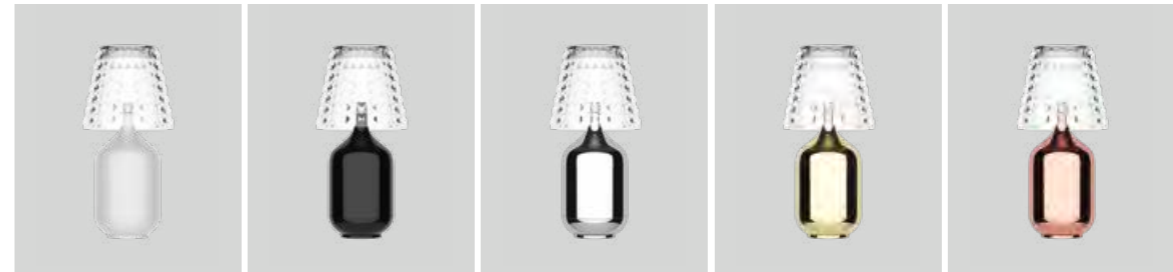

Valentina, design by Andrea Tosetto, 2018

Cordless table lamp

Valentina

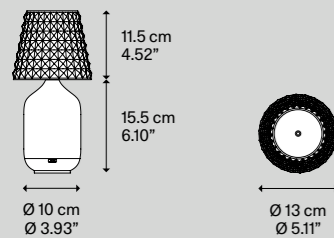

Light source
Sorgente luminosa

LED
 ↳ Dim-to-warm from 2600 K to 3300 K
 ↳ 3.5 W/450 lm
 ↳ 3400 mA Battery
 ↳ CRI 80
 ↳ MacAdam 3-Step

LED and battery included
 LED e batteria inclusi

PMMA structure
Montatura in PMMA

- Polished White – 9010
Bianco Lucido – 9010
- Polished Black – 9005
Nero Lucido – 9005
- Polished Chrome
Cromo Lucido
- Polished Gold
Oro Lucido
- Polished Rose Gold
Oro Rosa Lucido

Methacrylate diffuser
Diffusore in metacrilato

Clear
Trasparente

Code
Codice

- 166105
- 166106
- 166107
- 166108
- 166109

Net weight/Peso netto: 0.85 kg

Pack/Colli: 1

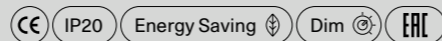
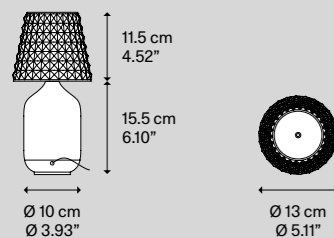

Table lamp

Valentina



Light source
Sorgente luminosa

LED
 ↳ 2700 K
 ↳ 6.5 W/510 lm
 ↳ 220-240 V
 ↳ CRI 92
 ↳ MacAdam 3-Step

LED included
 LED incluso

PMMA structure
Montatura in PMMA

- Polished White – 9010
Bianco Lucido – 9010
- Polished Black – 9005
Nero Lucido – 9005
- Polished Chrome
Cromo Lucido
- Polished Gold
Oro Lucido
- Polished Rose Gold
Oro Rosa Lucido

Methacrylate diffuser
Diffusore in metacrilato

Clear
Trasparente

Code
Codice

- 166110
- 166111
- 166112
- 166113
- 166114

Net weight/Peso netto: 0.80 kg

Pack/Colli: 1



Valentina, design by Andrea Tosetto, 2018

Wall lamp

Valentina

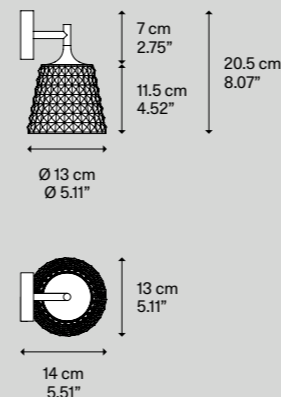

Light source
Sorgente luminosa

LED
 ↳ 2700 K
 ↳ 6.5 W/510 lm
 ↳ 220-240 V
 ↳ CRI 92
 ↳ MacAdam 3-Step

LED
 ↳ 3000 K
 ↳ 6.5 W/550 lm
 ↳ 220-240 V
 ↳ CRI 92
 ↳ MacAdam 3-Step

LED included
 LED incluso

Aluminium structure
Montatura in alluminio

Chrome
Cromo

Chrome
Cromo

Methacrylate diffuser
Diffusore in metacrilato

Clear
Trasparente

Clear
Trasparente

Code
Codice

- 166103
- 166104

Net weight/Peso netto: 0.42 kg

Pack/Colli: 1

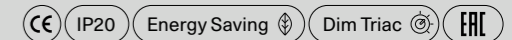

Cluster suspension lamp

Valentina

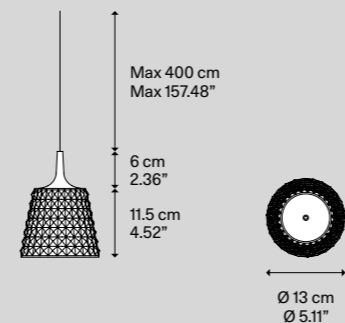

Light source
Sorgente luminosa

LED
 ↳ 2700 K
 ↳ 6.5 W/510 lm
 ↳ 220-240 V
 ↳ CRI 92
 ↳ MacAdam 3-Step

LED
 ↳ 3000 K
 ↳ 6.5 W/550 lm
 ↳ 220-240 V
 ↳ CRI 92
 ↳ MacAdam 3-Step

LED included
 LED incluso

Aluminium structure
Montatura in alluminio

Chrome
Cromo

Chrome
Cromo

Methacrylate diffuser
Diffusore in metacrilato

Clear
Trasparente

Clear
Trasparente

Code
Codice

- 166101
- 166102

Net weight/Peso netto: 0.45 kg

Pack/Colli: 1

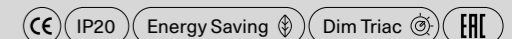

Suspension lamps must be installed on a canopy ▶ pag. 352-363
 Le lampade a sospensione devono essere installate su rosone ▶ pag. 352-363

Example of composition

5 Lights Round Cluster

1 × 100015

5 × 166101

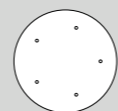

Battery charging time
Tempo di ricarica

Power supply 1A ▶ 180 min

Battery life
Durata batteria

Full power (100%) ▶ 5h
 Half power (50%) ▶ 10h
 Minimum power (10%) ▶ 15h

LED sources with direct power supply to the AC line voltage – driver not required. Dimmable with phase cut dimmer.

LED con alimentazione diretta a tensione di rete – non necessita di driver. Dimmerabile con varialuce a taglio di fase.

Beetle

Beetle is a family of uncomplicated wall and ceiling light fixtures featuring a methacrylate body available in different sizes and shapes. Thanks to its LED module and the geometric diffuser, Beetle delivers effective lighting in all directions.

Beetle è una famiglia di lampade da parete e soffitto essenziali, caratterizzata da un corpo diffusore in metacrilato disponibile in diverse dimensioni e forme. Grazie al modulo LED e al diffusore geometrico, Beetle illumina efficacemente e in tutte le direzioni.

Ceiling lamp, Wall lamp

Beetle mini cube,
FINISH White + Clear Ribbed

Beetle, *design by* Studio Italia Design, 2014

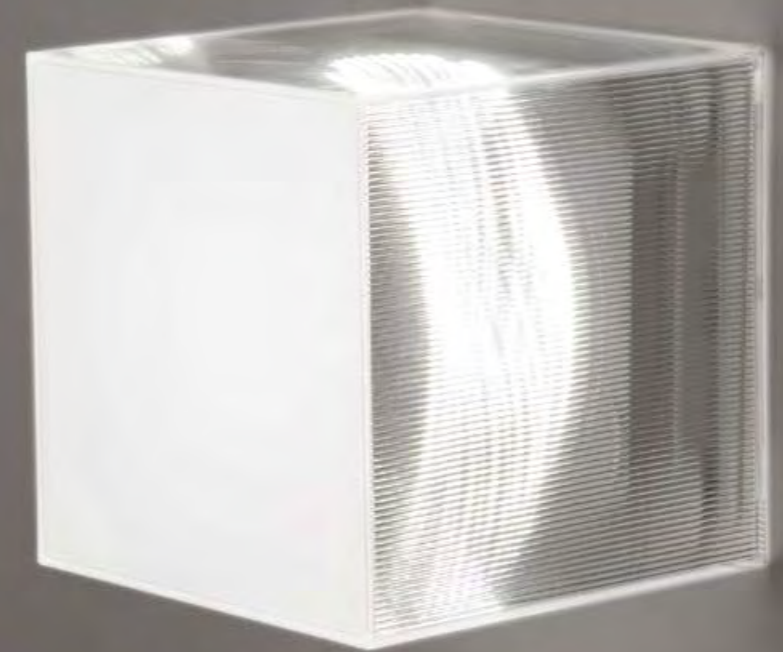

Beetle est une famille de lampes essentielles, appliques et plafonniers, caractérisée par un corps diffuseur en méthacrylate disponible en différentes tailles et formes. Grâce au module LED et au diffuseur géométrique, Beetle éclaire efficacement et dans toutes les directions. ● FR

Beetle ist eine Familie von unkomplizierten Wand- und Deckenleuchten mit einem Methacrylatkörper, der in verschiedenen Größen und Formen erhältlich ist. Dank seines LED-Moduls und des geometrischen Diffusors liefert Beetle eine effektive Beleuchtung in alle Richtungen. ● DE

Beetle es una familia de lámparas esenciales, de pared y de techo, caracterizada por un cuerpo difusor de metacrilato disponible en diferentes dimensiones y formas. Gracias al módulo LED y al difusor geométrico, Beetle ilumina eficazmente y en todas las direcciones. ● ES

Beetle – это семейство настенных и потолочных светильников сдержанного дизайна с метакрилатным диффузором различной формы и размера. Благодаря светодиодному модулю и оптимальной геометрии диффузора, Beetle обеспечивает эффективное освещение во всех направлениях. ● RU

Beetle是一个简约的灯具系列，有壁挂与吸顶款式，甲基丙烯酸酯灯罩可提供不同尺寸和形状，由于使用LED模块和几何造型的灯罩，Beetle可有效照亮所有方向。● ZH

Beetle, design by Studio Italia Design, 2014

Ceiling lamp

Wall lamp

Beetle mini cube

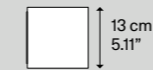
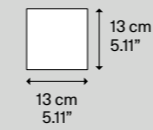

Light source
Sorgente luminosa

LED
↘ 3000 K
↘ 16 W / 1800 lm
↘ 220-240V
↘ CRI 92
↘ MacAdam 3-Step

LED included
LED incluso

Metal structure
Montatura in metallo

● Matte White – 9010
Bianco Opaco – 9010

● Matte White – 9010
Bianco Opaco – 9010

Polycarbonate diffuser
Diffusore in policarbonato

● White + Clear Ribbed
Bianco + Trasparente Rigato

● White
Bianco

Code
Codice

145001

145009

Net weight/Peso netto: 0.64 kg

Pack/Colli: 2

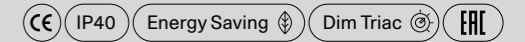

Beetle mini cube ↘ Ceiling lamp

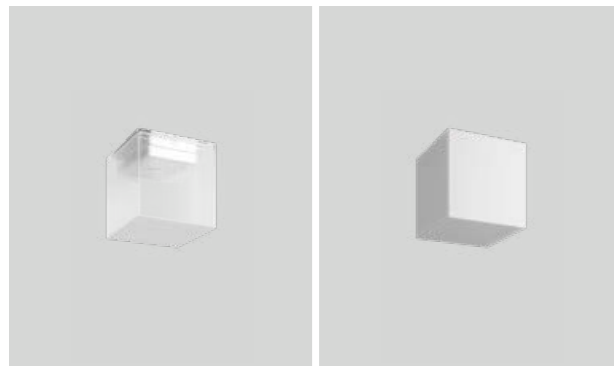

Beetle mini cube ↘ Wall lamp

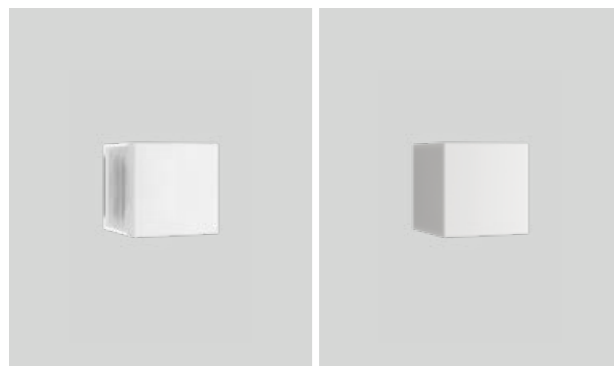

Make-Up

Make-Up's design is inspired by fashion and beauty. A versatile blown glass lamp with a gentle shape, Make-Up dresses walls and ceilings with light. Elegantly functional when used individually, it acquires a highly decorative appeal in lively compositions of different sizes and volumes.

Il design di Make-Up si ispira alla moda e alla bellezza. Lampada versatile in vetro soffiato dalla forma morbida, Make-Up veste di luce la parete e il soffitto. Elegantemente funzionale se usata singolarmente, acquista valore fortemente decorativo nelle vivaci composizioni di dimensioni e volumi diversi.

Wall lamp, Ceiling lamp

Make-Up,
FINISH Frosted White

Make-Up, *design by* Studio Italia Design, 2015



Make-Up small, medium and large,
FINISH Frosted White



Le design de Make-Up est inspiré par la mode et la beauté. Lampe polyvalente en verre soufflé de forme délicate, Make-Up habille de lumière les murs et le plafond. Élégamment fonctionnel en usage individuel, elle acquiert une grande valeur décorative dans des compositions dynamiques de tailles et de volumes différents. ●FR

Das Design von Make-Up ist von Mode und Schönheit inspiriert. Als vielseitige Lampe aus geblasenem Glas mit ihrer weichen Form kleidet Make-Up Wand und Decke mit Licht. Bei einzelner Verwendung ist sie elegant und funktionell, als lebhaft Kombination aus verschiedenen Größen und Volumen wird sie hingegen zu einem besonderen Dekorationselement. ●DE

El diseño de Make-Up está inspirado en la moda y la belleza. Una versátil lámpara de vidrio soplado de forma delicada, Make-Up viste de luz la pared y el techo. Elegantemente funcional cuando se usa individualmente, adquiere un alto valor decorativo en composiciones llamativas de diferentes tamaños y volúmenes. ●ES

Дизайн Make-Up навеян модой и красотой. Модульный светильник из выдувного стекла мягкой формы может украсить своим светом как стену, так и потолок. Элегантен и эффективен даже по отдельности, а в составных композициях различных размеров и объемов приобретает еще большую декоративную ценность. ●RU

Make-Up设计灵感来自时尚与美。组合式吹制玻璃吊灯外形柔和，为墙壁或天花板增添光彩。优雅实用，单独使用具有强烈的装饰性，可组成各种尺寸和体积的活泼组合。●ZH

Make-Up small ↘ Wall lamp Make-Up medium ↘ Wall lamp Make-Up large ↘ Wall lamp

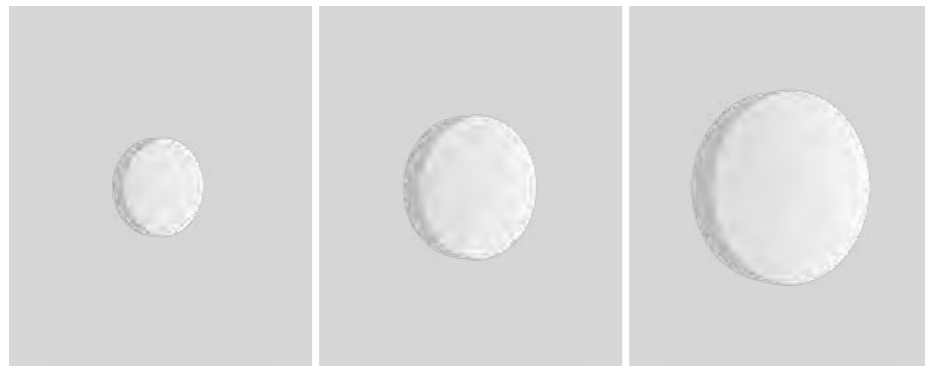

Make-Up small ↘ Ceiling lamp Make-Up medium ↘ Ceiling lamp Make-Up large ↘ Ceiling lamp

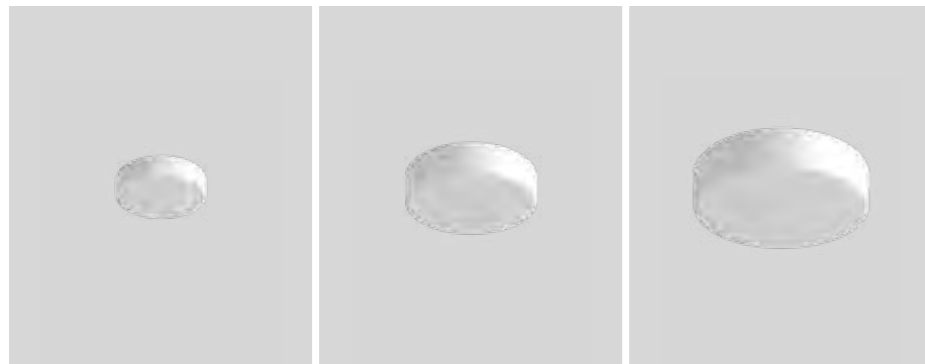

Make-Up, design by Studio Italia Design, 2015

Wall lamp

Ceiling lamp

Make-Up small

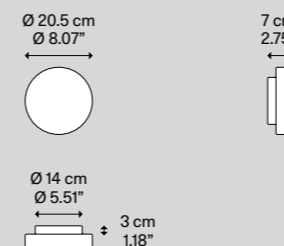

Light source
Sorgente luminosa

LED
↘ 3000 K
↘ 9 W/980 lm
↘ 220-240 V
↘ CRI 92
↘ MacAdam 3-Step

Metal structure
Montatura in metallo

Matte White - 9016
Bianco Opaco - 9016

Blown glass diffuser
Diffusore in vetro soffiato

Frosted White
Bianco Satinato

Code
Codice

150003

LED included
LED incluso

Net weight/Peso netto: 1.3 kg

Pack/Colli: 1

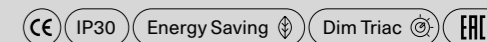

Make-Up medium

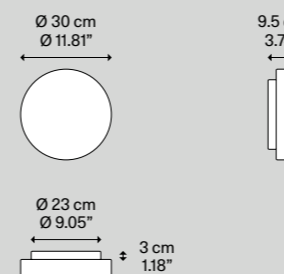

Light source
Sorgente luminosa

LED
↘ 3000 K
↘ 16 W/1800 lm
↘ 220-240 V
↘ CRI 92
↘ MacAdam 3-Step

Metal structure
Montatura in metallo

Matte White - 9016
Bianco Opaco - 9016

Blown glass diffuser
Diffusore in vetro soffiato

Frosted White
Bianco Satinato

Code
Codice

150002

LED included
LED incluso

Net weight/Peso netto: 2.32 kg

Pack/Colli: 1

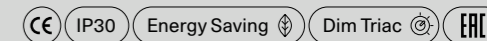

Make-Up large

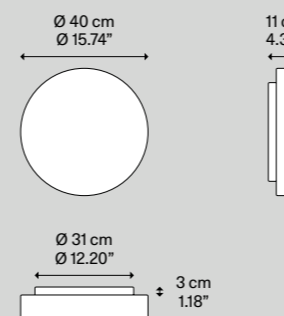

Light source
Sorgente luminosa

LED
↘ 3000 K
↘ 16 W/1800 lm
↘ 220-240 V
↘ CRI 92
↘ MacAdam 3-Step

Metal structure
Montatura in metallo

Matte White - 9016
Bianco Opaco - 9016

Blown glass diffuser
Diffusore in vetro soffiato

Frosted White
Bianco Satinato

Code
Codice

150001

LED included
LED incluso

Net weight/Peso netto: 3.88 kg

Pack/Colli: 1

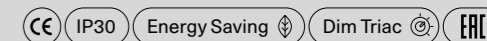

► LED sources with direct power supply to the AC line voltage - driver not required. Dimmable with phase cut dimmer. ► You can connect up to 3 Make-Up to each fixture directly connected to the power supply. You can also connect up to 2 additional fixtures to each of those for maximum total of 50 fixtures on a single power outlet.

► LED con alimentazione diretta a tensione di rete - non necessita di driver. Dimmerabile con varialuce a taglio di fase. ► Ad ogni Make-Up connessa al punto di alimentazione elettrica possono esserne collegate altre 3. Ad ognuna di queste possono esserne collegate fino a 2 e così via. Le lampade totali collegabili su un singolo punto di alimentazione sono 50.

Frozen

Frozen is a lamp with a minimalist design that seems to blend in with the ceiling. From the thin painted steel frame, crystal lenses set like gems diffuse a harmonious direct light that gives life to the environment.

Frozen è una lampada dal design minimalista che sembra aderire al soffitto. Dalla sottile montatura in acciaio verniciato, lenti in cristallo incastonate come gemme diffondono un'armoniosa luce diretta che dà vita all'ambiente.

Ceiling lamp

Frozen large,
FINISH Matte White

Frozen, *design by* Studio Italia Design, 2015



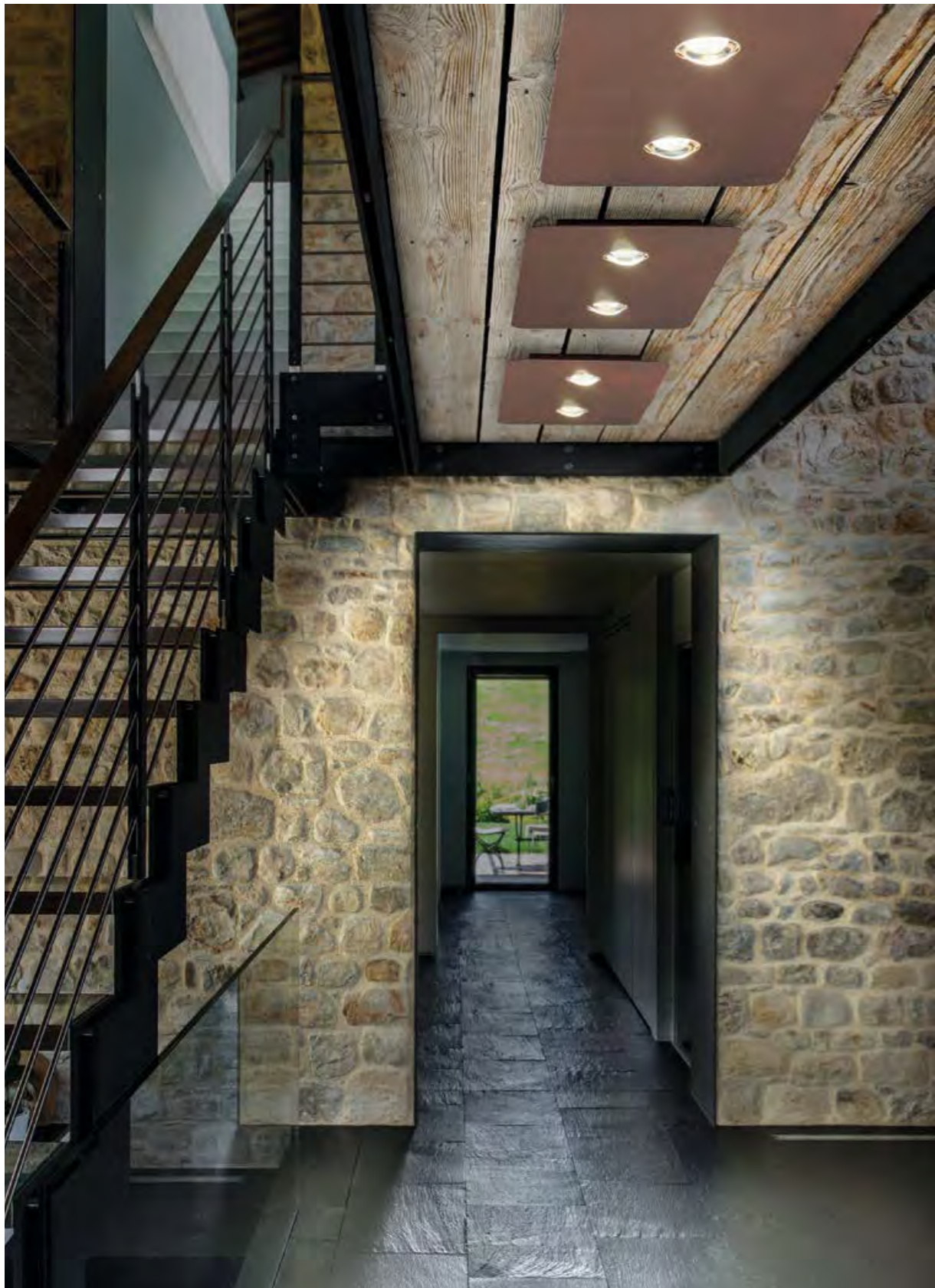

Frozen medium, FINISH Coppery Bronze

Frozen small,
FINISH Coppery Bronze

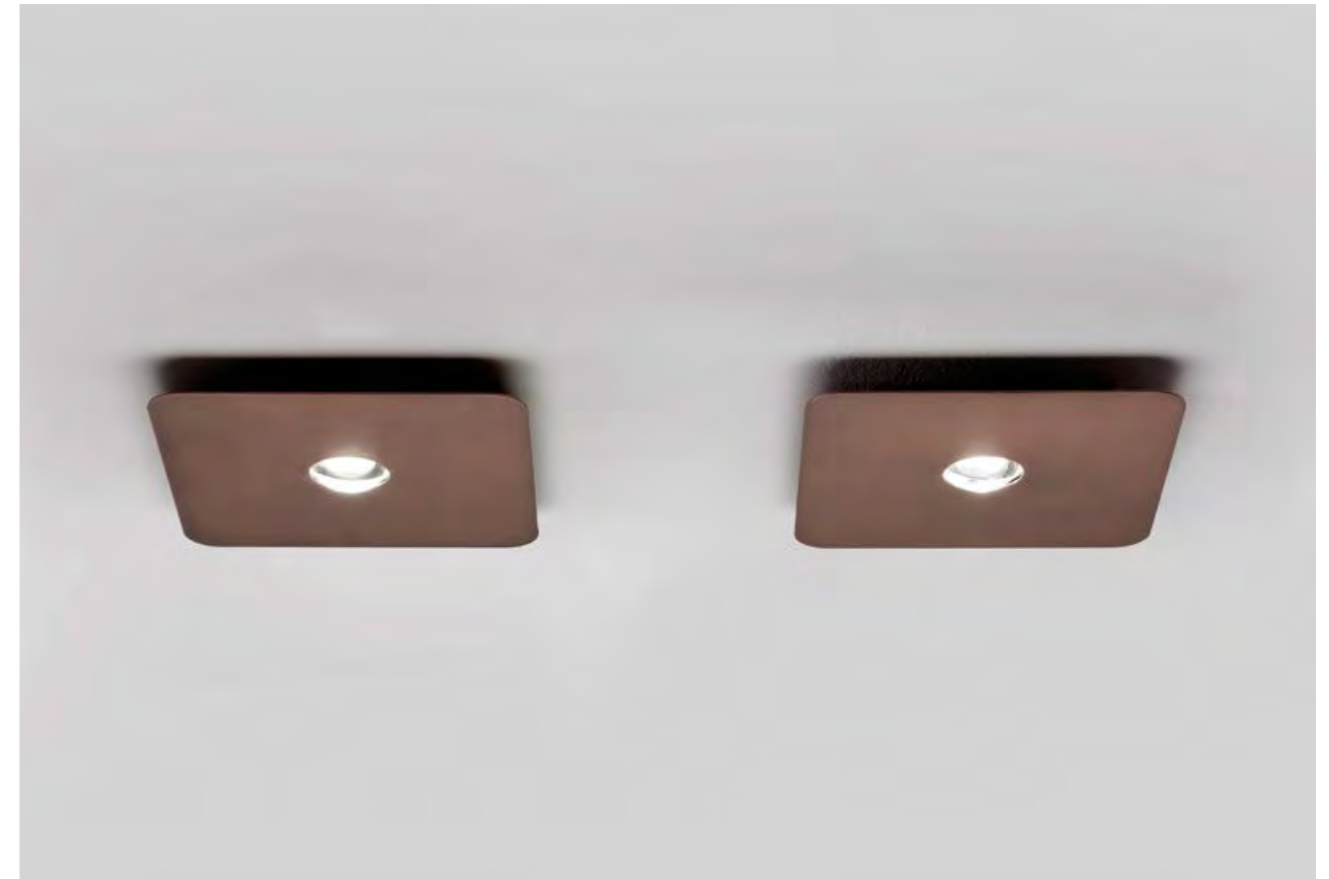

Frozen est une lampe au design minimaliste qui semble adhérer au plafond. De la fine armature en acier peint, ses verres de cristal sertis comme des pierres précieuses diffusent une lumière directe harmonieuse qui donne vie à l'environnement. ●FR

Frozen ist eine Leuchte mit minimalistischem Design, die an der Decke zu haften scheint. Aus dem dünnen, lackierten Stahlrahmen streuen wie Edelsteine gefasste Kristalllinsen ein harmonisches, direktes Licht, das der Umgebung Leben einhaucht. ●DE

Frozen es una lámpara de diseño minimalista que parece adherirse al techo. Con un cuerpo delgado de acero pintado, lentes de cristal incrustado como gemas difunden una luz armónica directa que da vida al ambiente. ●ES

Frozen – это светильник в минималистичном стиле, который как будто прилип к потолку. Имеет тонкое основание из окрашенной стали и хрустальные линзы, которые, словно драгоценные камни в оправе, распространяют гармоничный прямой свет, наполняющий жизнью окружающее пространство. ●RU

Frozen 是一盏极简设计的灯，似乎贴在天花板上。纤细的喷漆钢质结构，镶嵌水晶镜片如同一块宝石，散发着和谐的直接光线，为环境赋予生气。●ZH

Frozen small ↘ Ceiling lamp

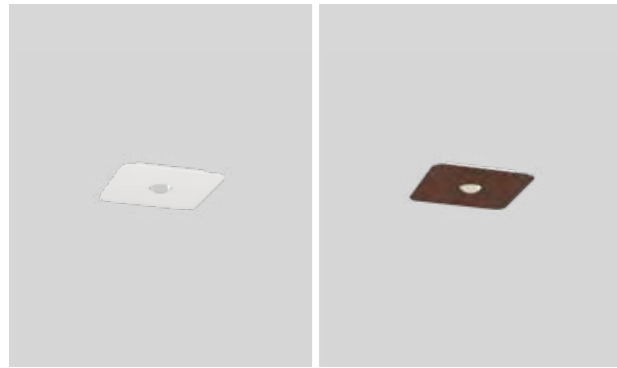

Frozen medium ↘ Ceiling lamp



Frozen large ↘ Ceiling lamp



Frozen, design by Studio Italia Design, 2015

Ceiling lamp

Frozen small

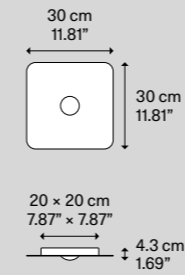

Light source
Sorgente luminosa

LED
↘ 2700 K
↘ 15 W/1400 lm
↘ 220-240 V
↘ CRI 90
↘ MacAdam 3-Step

or

LED
↘ 3000 K
↘ 15 W/1520 lm
↘ 220-240 V
↘ CRI 90
↘ MacAdam 3-Step

LED included
LED incluso

Metal structure
Montatura in metallo

Matte White – 9010
Bianco Opaco – 9010

Coppery Bronze
Bronzo Ramato

Matte White – 9010
Bianco Opaco – 9010

Coppery Bronze
Bronzo Ramato

Code
Codice

149019

149020

149003

149007

Net weight/Peso netto: 1.77 kg

Pack/Coll: 1

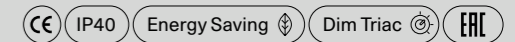

Frozen medium

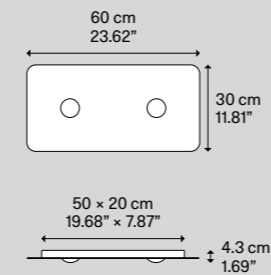

LED
↘ 2700 K
↘ 2 x 15 W/2800 lm
↘ 220-240 V
↘ CRI 90
↘ MacAdam 3-Step

or

LED
↘ 3000 K
↘ 2 x 15 W/3040 lm
↘ 220-240 V
↘ CRI 90
↘ MacAdam 3-Step

LED included
LED incluso

Matte White – 9010
Bianco Opaco – 9010

Coppery Bronze
Bronzo Ramato

Matte White – 9010
Bianco Opaco – 9010

Coppery Bronze
Bronzo Ramato

149017

149018

149002

149006

Net weight/Peso netto: 3.27 kg

Pack/Coll: 1

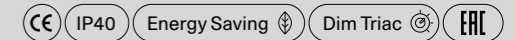

Frozen large

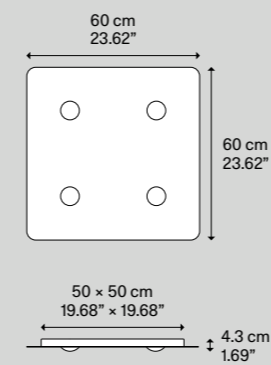

LED
↘ 2700 K
↘ 4 x 15 W/5600 lm
↘ 220-240 V
↘ CRI 90
↘ MacAdam 3-Step

or

LED
↘ 3000 K
↘ 4 x 15 W/6080 lm
↘ 220-240 V
↘ CRI 90
↘ MacAdam 3-Step

LED included
LED incluso

Matte White – 9010
Bianco Opaco – 9010

Coppery Bronze
Bronzo Ramato

Matte White – 9010
Bianco Opaco – 9010

Coppery Bronze
Bronzo Ramato

149015

149016

149001

149005

Net weight/Peso netto: 7.78 kg

Pack/Coll: 1

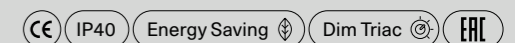

Canopies

A Single Canopy	Single Mini Recessed Micro Wall Standard Single Standard
B Track System	Short Lights Track Long Lights Track
C Cluster System	3 Lights Round Cluster 5 Lights Round Cluster 7 Lights Round Cluster 14 Lights Round Cluster 24 Lights Round Cluster 36 Lights Round Cluster 7 Lights Rectangular Cluster 14 Lights Rectangular Cluster 28 Lights Rectangular Cluster
D Radial Systems	Single or Double Radial Canopy 4 Lights Radial Cluster 12 Lights Radial Cluster 28 Lights Radial Cluster

A Single Canopies

Single canopies are ideal for highlighting the corner of a room or enhancing single light sources. They can also be used to create multiple custom combinations on high ceilings or in situations which do not allow lights to be grouped in a cluster.

B Track Systems

Track systems offers various possibilities of in-line composition with a variable number of lamps depending on the preferred type of installation, i.e. height-aligned or staggered suspensions.

C Round and Rectangular Cluster Systems

Our multiple canopies, round or rectangular, are functional systems to create suspended compositions with a variable but predefined number of holes.

D Radial Systems

Radial systems are an innovative way to separately manage various suspension cables starting from one single canopy—particularly useful to illuminate rooms with irregular ceilings.

A Rosoni Singoli

I rosoni singoli si prestano ad enfatizzare gli angoli di una stanza o a valorizzare i singoli corpi luce. Possono inoltre essere utilizzati per creare composizioni multiple personalizzate su soffitti molto alti o nelle situazioni che non permettono l'utilizzo di cluster.

B Sistemi a Binario Lineare

I sistemi a binario offrono varie possibilità di composizione in linea con un numero variabile di lampade a seconda del tipo di installazione desiderato, ossia sospensioni allineate in altezza o sfalsate.



C Sistemi Cluster Rotondi e Rettangolari

I nostri rosoni multipli, rotondi o rettangolari, sono sistemi funzionali per creare composizioni sospese con un numero di fori variabile ma predefinito.







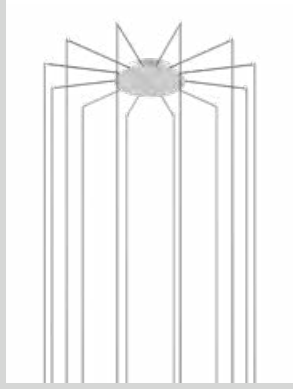





D Sistemi Radiali

I sistemi radiali sono un modo innovativo per gestire separatamente diversi cavi di sospensione a partire da un unico rosone – particolarmente utili per illuminare ambienti con soffitti irregolari.

Cluster Systems

Canopies Rosoni	Typology Tipologia	Variants Varianti
	A Single Canopies	A. 1 Single Mini A. 2 Recessed Micro A. 3 Wall Standard A. 4 Single Standard
	B Track Systems	B. 1 Short B. 2 Long
	C Cluster Systems	C. 1 3 Lights Round C. 2 5 Lights Round C. 3 7 Lights Round C. 4 14 Lights Round C. 5 24 Lights Round C. 6 36 Lights Round C. 7 7 Lights Rectangular C. 8 14 Lights Rectangular C. 9 28 Lights Rectangular
	D Radial Systems	D. 1 Single or Double Radial Canopy D. 2 4 Lights Radial D. 3 12 Lights Radial D. 4 28 Lights Radial

Cluster suspension lamps

							
A-Tube A, B, C, D	A-Tube Nano A, B, C	A-Tube Nano Duo A, B, C	Jefferson A, B, C	JIM A, B, C, D NEW LAMP	Kelly Cluster A, B, C, D	Nostalgia A, B, C, D	Rain A, B, C, D
							
Random A, B, C, D	Random Solo A, B, C NEW LAMP	Spider A, B, C, D	Valentina A, B, C, D				

134	A-Tube	A, B, C, D
108	A-Tube Nano	A, B, C
124	A-Tube Nano Duo	A, B, C
208	Jefferson	A, B, C
220	JIM	A, B, C, D
238	Kelly Cluster	A, B, C, D
192	Nostalgia	A, B, C, D
062	Rain	A, B, C, D
178	Random	A, B, C, D
162	Random Solo	A, B, C
076	Spider	A, B, C, D
324	Valentina	A, B, C, D

Single Canopy

Single Mini

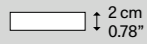
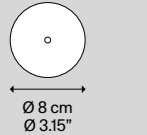

Description Descrizione	Metal structure Struttura in metallo	System Sistema	Code Codice
Single ceiling bracket small size	<ul style="list-style-type: none"> Matte White – 9010 Bianco Opaco – 9010 	Single System	100033
Rosone per lampada singola versione mini	<ul style="list-style-type: none"> Matte Black – 9005 Nero Opaco – 9005 		100034
	<ul style="list-style-type: none"> Matte Coppery Bronze Bronzo Ramato Opaco 		100035
	<ul style="list-style-type: none"> Chrome Cromo 		100036
	<ul style="list-style-type: none"> Matte Champagne ^{NEW} Champagne Opaco 		100042

Net weight/Peso netto: 0.13 kg Pack/Colli: 1



Recessed Canopy

Recessed Micro

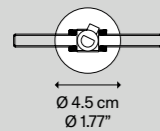
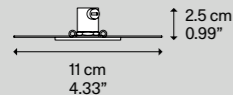
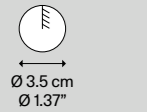

Description Descrizione	Metal structure Struttura in metallo	System Sistema	Code Codice
Recessed bracket for single lamp max capacity 3.5 kg	<ul style="list-style-type: none"> Matte White – 9010 Bianco Opaco – 9010 	Recessed System	100037
Rosone da incasso per lampada singola portata max 3.5 kg	<ul style="list-style-type: none"> Chrome Cromo 		100040
	<ul style="list-style-type: none"> Matte Black – 9005 Nero Opaco – 9005 		100065

Net weight/Peso netto: 0.032 kg Pack/Colli: 1



Wall Bracket

Wall Standard

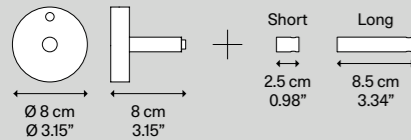

Description Descrizione	Metal structure Struttura in metallo	System Sistema	Code Codice
Wall bracket for suspension modular system	<ul style="list-style-type: none"> Chrome Cromo 	Wall System	100038
Supporto a parete per sistema modulare a sospensione			

Net weight/Peso netto: 0.8 kg Pack/Colli: 1



Single Canopy

Single Standard

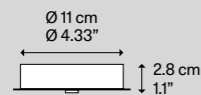
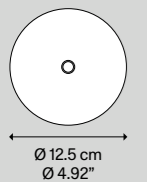

Description Descrizione	Metal structure Struttura in metallo	System Sistema	Code Codice
Single ceiling bracket standard size	<ul style="list-style-type: none"> Matte White – 9010 Bianco Opaco – 9010 	Single System	100013
Rosone per lampada singola versione standard			

Net weight/Peso netto: 0.4 kg Pack/Colli: 1



RECESSED MICRO ► Suitable for ceilings up to 2.4 cm thickness. WALL STANDARD ► Both accessories in the two available lengths are supplied in the box with the wall bracket.

RECESSED MICRO ► Adatta per soffitti fino a 2.4 cm di spessore. WALL STANDARD ► Entrambi gli accessori nelle due diverse lunghezze sono inclusi nella confezione con il supporto a parete.

Track System

Short Lights Track

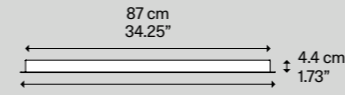
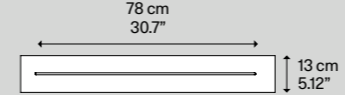

Net weight/Peso netto: 5.5 kg Pack/Colli: 1



Description Descrizione	Structure finish Finitura struttura	System Sistema	Code Codice
Multiple linear track standard version max 7 suspensions	<ul style="list-style-type: none"> Matte White – 9010 Bianco Opaco – 9010 	Track System	100029
Binario lineare multiplo versione standard max 7 sospensioni	<ul style="list-style-type: none"> Matte Black – 9005 ^{NEW} Nero Opaco – 9005 		100066

Short Track System

Maximum quantity Quantità massima		Maximum quantity Quantità massima	
Suspension aligned Sospensione allineata		Staggered suspension Sospensione sfalsata	
Max 7	mod. A-Tube	Max 7	mod. A-Tube
Max 6	mod. A-Tube Nano	Max 6	mod. A-Tube Nano
Max 6	mod. A-Tube Nano Duo	Max 6	mod. A-Tube Nano Duo
Max 5	mod. Jefferson	Max 6	mod. Jefferson
Max 4	mod. JIM cylinder	Max 7	mod. JIM cylinder
Max 3	mod. JIM cone	Max 5	mod. JIM cone
Max 3	mod. JIM bell	Max 5	mod. JIM bell
Max 4	mod. Kelly Cluster	Max 7	mod. Kelly Cluster
Max 7	mod. Nostalgia small	Max 7	mod. Nostalgia small
Max 4	mod. Nostalgia medium	Max 7	mod. Nostalgia medium
Max 3	mod. Nostalgia large	Max 5	mod. Nostalgia large
Max 7	mod. Rain	Max 7	mod. Rain
Max 3	mod. Random	Max 5	mod. Random
Max 7	mod. Random Solo 12	Max 7	mod. Random Solo 12
Max 6	mod. Random Solo 14	Max 7	mod. Random Solo 14
Max 4	mod. Random Solo 18	Max 7	mod. Random Solo 18
Max 4	mod. Random Solo 23	Max 7	mod. Random Solo 23
Max 3	mod. Random Solo 28	Max 6	mod. Random Solo 28
Max 7	mod. Spider	Max 7	mod. Spider
Max 7	mod. Valentina	Max 7	mod. Valentina

Track System

Long Lights Track

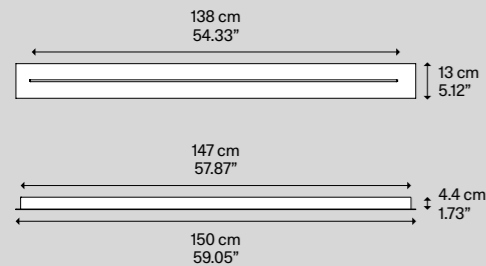

Net weight/Peso netto: 8.8 kg Pack/Colli: 1

Description Descrizione	Structure finish Finitura struttura	System Sistema	Code Codice
Multiple linear track standard version max 11 suspensions Binario lineare multiplo versione standard max 11 sospensioni	● Matte White - 9010 Bianco Opaco - 9010	Track System	100030
	● Matte Black - 9005 <small>NEW</small> Nero Opaco - 9005		100067

CE IP20

Long Track System

Maximum quantity Quantità massima		Maximum quantity Quantità massima	
Suspension aligned Sospensione allineata		Staggered suspension Sospensione sfalsata	
Max 11	mod. A-Tube	Max 11	mod. A-Tube
Max 10	mod. A-Tube Nano	Max 10	mod. A-Tube Nano
Max 10	mod. A-Tube Nano Duo	Max 10	mod. A-Tube Nano Duo
Max 8	mod. Jefferson	Max 10	mod. Jefferson
Max 8	mod. JIM cylinder	Max 11	mod. JIM cylinder
Max 5	mod. JIM cone	Max 9	mod. JIM cone
Max 5	mod. JIM bell	Max 9	mod. JIM bell
Max 8	mod. Kelly Cluster	Max 11	mod. Kelly Cluster
Max 11	mod. Nostalgia small	Max 11	mod. Nostalgia small
Max 7	mod. Nostalgia medium	Max 11	mod. Nostalgia medium
Max 5	mod. Nostalgia large	Max 9	mod. Nostalgia large
Max 11	mod. Rain	Max 11	mod. Rain
Max 5	mod. Random	Max 9	mod. Random
Max 11	mod. Random Solo 12	Max 11	mod. Random Solo 12
Max 10	mod. Random Solo 14	Max 11	mod. Random Solo 14
Max 8	mod. Random Solo 18	Max 11	mod. Random Solo 18
Max 6	mod. Random Solo 23	Max 11	mod. Random Solo 23
Max 6	mod. Random Solo 28	Max 10	mod. Random Solo 28
Max 11	mod. Spider	Max 11	mod. Spider
Max 11	mod. Valentina	Max 11	mod. Valentina

Cluster System

3 Lights Round Cluster

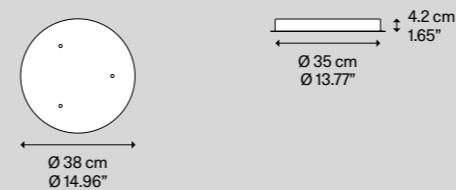

Net weight/Peso netto: 3.55 kg Pack/Colli: 1

Description Descrizione	Metal structure Struttura in metallo	System Sistema	Code Codice
Round canopy for 3 suspensions Rosone circolare per 3 sospensioni	● Matte White - 9010 Bianco Opaco - 9010	Cluster System	100014
	● Matte Black - 9005 <small>NEW</small> Nero Opaco - 9005		100058

CE IP20

5 Lights Round Cluster

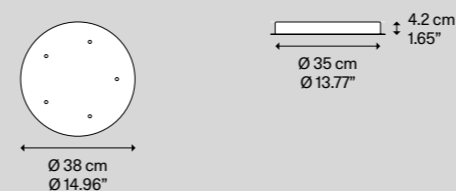

Net weight/Peso netto: 3.55 kg Pack/Colli: 1

Description Descrizione	Metal structure Struttura in metallo	System Sistema	Code Codice
Round canopy for 5 suspensions Rosone circolare per 5 sospensioni	● Matte White - 9010 Bianco Opaco - 9010	Cluster System	100015
	● Matte Black - 9005 <small>NEW</small> Nero Opaco - 9005		100059

CE IP20

7 Lights Round Cluster

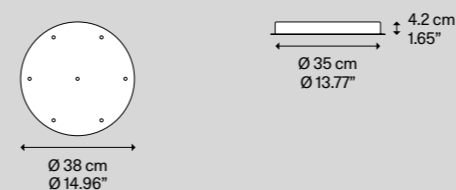

Net weight/Peso netto: 3.55 kg Pack/Colli: 1

Description Descrizione	Metal structure Struttura in metallo	System Sistema	Code Codice
Round canopy for 7 suspensions Rosone circolare per 7 sospensioni	● Matte White - 9010 Bianco Opaco - 9010	Cluster System	100016
	● Matte Black - 9005 <small>NEW</small> Nero Opaco - 9005		100060

CE IP20

14 Lights Round Cluster

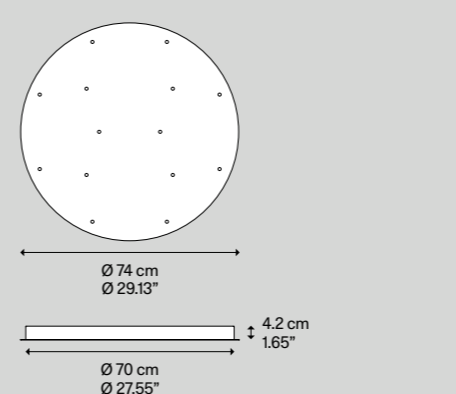

Net weight/Peso netto: 14.14 kg Pack/Colli: 1

Description Descrizione	Metal structure Struttura in metallo	System Sistema	Code Codice
Round canopy for 14 suspensions Rosone circolare per 14 sospensioni	● Matte White - 9010 Bianco Opaco - 9010	Cluster System	100017
	● Matte Black - 9005 <small>NEW</small> Nero Opaco - 9005		100057

CE IP20

Cluster System

24 Lights Round Cluster

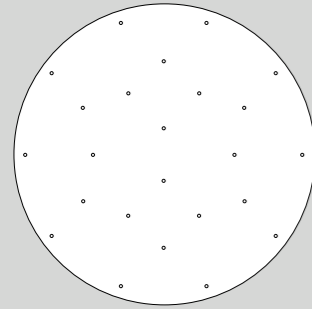

Ø 100 cm
Ø 39.37"

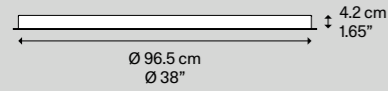

Ø 96.5 cm
Ø 38"

Net weight/Peso netto: 23.5 kg Pack/Colli: 1

Description Descrizione	Metal structure Struttura in metallo	System Sistema	Code Codice
Round canopy for 24 suspensions	● Matte White – 9010 Bianco Opaco – 9010	Cluster System	100025
Rosone circolare per 24 sospensioni	● Matte Black – 9005 ^{NEW} Nero Opaco – 9005		100056

CE IP20

36 Lights Round Cluster

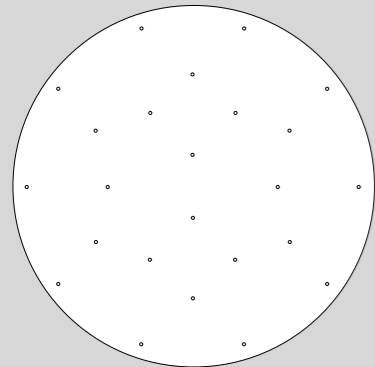

Ø 120 cm
Ø 47.24"

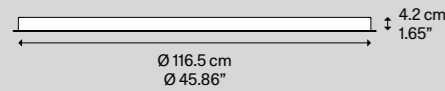

Ø 116.5 cm
Ø 45.86"

Net weight/Peso netto: 32.7 kg Pack/Colli: 1

Description Descrizione	Metal structure Struttura in metallo	System Sistema	Code Codice
Round canopy for 36 suspensions	● Matte White – 9010 Bianco Opaco – 9010	Cluster System	100018
Rosone circolare per 36 sospensioni	● Matte Black – 9005 ^{NEW} Nero Opaco – 9005		100061

CE IP20

Cluster System

7 Lights Rectangular Cluster

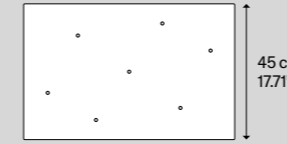

45 cm
17.71"

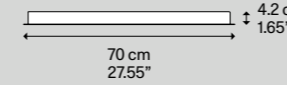

4.2 cm
1.65"

Net weight/Peso netto: 9.89 kg Pack/Colli: 1

Description Descrizione	Metal structure Struttura in metallo	System Sistema	Code Codice
Rectangular canopy for 7 suspensions	● Matte White – 9010 Bianco Opaco – 9010	Cluster System	100019
Rosone rettangolare per 7 sospensioni	● Matte Black – 9005 ^{NEW} Nero Opaco – 9005		100062

CE IP20

14 Lights Rectangular Cluster

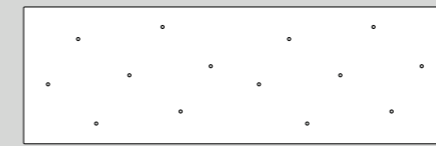

45 cm
17.71"

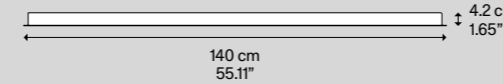

4.2 cm
1.65"

Net weight/Peso netto: 17.1 kg Pack/Colli: 1

Description Descrizione	Metal structure Struttura in metallo	System Sistema	Code Codice
Rectangular canopy for 14 suspensions	● Matte White – 9010 Bianco Opaco – 9010	Cluster System	100020
Rosone rettangolare per 14 sospensioni	● Matte Black – 9005 ^{NEW} Nero Opaco – 9005		100063

CE IP20

28 Lights Rectangular Cluster



90 cm
35.43"

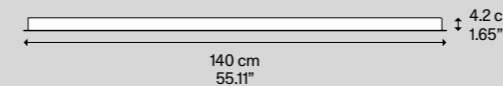

4.2 cm
1.65"

Net weight/Peso netto: 31.1 kg Pack/Colli: 1

Description Descrizione	Metal structure Struttura in metallo	System Sistema	Code Codice
Rectangular canopy for 28 suspensions	● Matte White – 9010 Bianco Opaco – 9010	Cluster System	100021
Rosone rettangolare per 28 sospensioni	● Matte Black – 9005 ^{NEW} Nero Opaco – 9005		100064

CE IP20

Radial System

Swag Kit for Radial Canopy

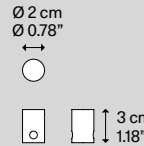
Description Descrizione	Polycarbonate structure Struttura in policarbonato	System Sistema	Code Codice
 <p>Wall and ceiling anchor for Radial System power cable max \varnothing 7 mm max capacity 5 kg</p> <p>Cilindro di decentramento per Sistema Radiale cavo elettrico max \varnothing 7 mm Portata max 5 kg</p>	<p>● Clear Trasparente</p>	Radial System	130109
<p>Net weight/Peso netto: 0.02 kg</p> <p>Pack/Colli: 1</p>		<p>CE IP20</p>	

Single or Double Radial Canopy

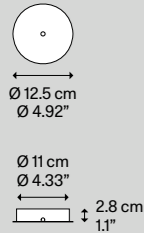
Description Descrizione	Metal structure Struttura in metallo	System Sistema	Code Codice
 <p>Ceiling bracket for single decentralized suspension or double opposed</p> <p>Rosone circolare per sospensione singola decentrata o doppia contrapposta</p> <p>Radial Swag Kit not included</p> <p>Radial Swag Kit non incluso</p>	<p>● Matte White – 9010 Bianco Opaco – 9010</p> <p>● Matte Black – 9005 ^{NEW} Nero Opaco – 9005</p>	Radial System	100026 100068
<p>Net weight/Peso netto: 0.35 kg</p> <p>Pack/Colli: 1</p>		<p>CE IP20</p>	

Radial System

4 Lights Radial Cluster

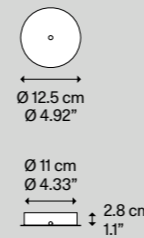
Description Descrizione	Metal structure Struttura in metallo	System Sistema	Code Codice
 <p>Radial canopy max 4 suspensions</p> <p>Rosone radiale max 4 sospensioni</p> <p>Radial Swag Kit not included</p> <p>Radial Swag Kit non incluso</p>	<p>● Matte White – 9010 Bianco Opaco – 9010</p> <p>● Matte Black – 9005 ^{NEW} Nero Opaco – 9005</p>	Radial System	100041 100069
<p>Net weight/Peso netto: 0.35 kg</p> <p>Pack/Colli: 1</p>		<p>CE IP20</p>	

12 Lights Radial Cluster

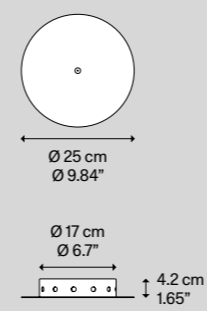
Description Descrizione	Metal structure Struttura in metallo	System Sistema	Code Codice
 <p>Radial canopy max 12 suspension</p> <p>Rosone radiale max 12 sospensioni</p> <p>Radial Swag Kit not included</p> <p>Radial Swag Kit non incluso</p>	<p>● Matte White – 9010 Bianco Opaco – 9010</p> <p>● Matte Black – 9005 ^{NEW} Nero Opaco – 9005</p>	Radial System	100027 100070
<p>Net weight/Peso netto: 1.05 kg</p> <p>Pack/Colli: 1</p>		<p>CE IP20</p>	

28 Lights Radial Cluster

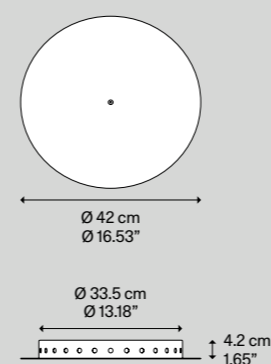
Description Descrizione	Metal structure Struttura in metallo	System Sistema	Code Codice
 <p>Radial canopy max 28 suspension</p> <p>Rosone radiale max 28 sospensioni</p> <p>Radial Swag Kit not included</p> <p>Radial Swag Kit non incluso</p>	<p>● Matte White – 9010 Bianco Opaco – 9010</p> <p>● Matte Black – 9005 ^{NEW} Nero Opaco – 9005</p>	Radial System	100028 100071
<p>Net weight/Peso netto: 3.35 kg</p> <p>Pack/Colli: 1</p>		<p>CE IP20</p>	

Finishes

A Foundational	367 Black	367 Grey	368 White	369 Clear
B Precious	371 Palladium	372 Silver	373 Gold	
C Warm	375 Bronze	375 Honey		
D Trend	377 Green	377 Yellow	377 Red	
E Pastels, Revisited	379 Turquoise	379 Taupe	379 Pink	

The contemporary tones of our colour range enhance Lodes' versatile and eclectic character – sophisticated tones that blend in harmony, as well as bolder tones that allow for a more personal inspiration.

I toni contemporanei della nostra gamma esaltano il carattere versatile ed eclettico di Lodes – toni sofisticati che dialogano armoniosamente, ma anche toni più audaci che lasciano spazio all'estro personale.

A Foundational	Simple and elegant – the foundation of our colour stories	Semplici ed eleganti – le basi delle nostre storie di colore
	Black Grey White Clear	
B Precious	A subtle touch of great value	Un sottile tocco di grande valore
	Palladium Chrome Gold Matte Champagne Rose Gold	
C Warm	Feelings of comfort, pleasurable experiences	Sensazioni di conforto, esperienze piacevoli
	Bronze Honey	
D Trend	Powerful colours with a bold personality	Colori importanti con una spiccata personalità
	Green Yellow Lacquer Red	
E Pastels, Revisited	Like the precious tesserae of byzantine mosaics, Lodes' pastels are veritable accents of energy	Come le preziose tessere dei mosaici bizantini, i toni pastello di Lodes sono veri e propri accenti di energia
	Turquoise Taupe Pink	

Foundational

Black

Grey

White

Clear

Black

Foundational

► 1/4

Black is both the absence of colour and the strength that bestows depth and hues to its surroundings. At Lodes, dark nuances are tailored to the materials that don them.

The *matte black* finish clads metal lamps with confidence and sophistication. Its quintessential toughness makes it an understated solid block on which to build a personal style of décor.

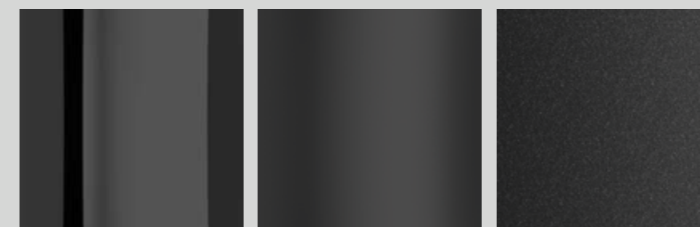

1 Glossy Black - 9005
Nero Lucido - 9005

2 Matte Black - 9005
Nero Opaco - 9005

3 Anthracite Black
Nero Antracite

Il nero è sia l'assenza di colore che la forza che conferisce profondità e sfumature all'ambiente circostante. Le tonalità scure di Lodes sono studiate a misura dei materiali che le presentano.

La finitura *nera opaca (matte black)* veste le lampade in metallo con personalità e raffinatezza. La sua intrinseca solidità la rende un tassello raffinato e discreto su cui costruire un arredamento personale.

Products

- 2 Aile
- 2 A-Tube
- 2 A-Tube Nano
- 2 A-Tube Nano Duo
- 1 Bugia
- 2 Cima
- 2 JIM
- 2 Kelly Cluster
- 2 Kelly dome
- 2 Laser
- 2 Nautilus
- 2 Nautilus Mini
- 2 Nautilus Spot
- 2 Puzzle
- 3 Puzzle Outdoor
- 2 Puzzle Round
- 2 Pin-Up
- 2 Rain
- 2 Spider
- 1 Valentina

Grey

Foundational

► 2/4

On blown *glass*, grey filters the light like a delicate veil, while on translucent polymers it shines like a precious decorative accent suspended in the room.

The *smoke* finish enhances the precision of the blown glass and endows it with a subtle urban allure. This dark hue is enriched with a precious *glossy* treatment, becoming a refined and understated decorative accent.



1 Grey
Grigio

2 Glossy Smoke
Fumo Lucido

In vetro soffiato filtra la luce come un velo delicato, mentre sui polimeri traslucidi il *grigio (grey)* brilla come un prezioso accento decorativo sospeso nella stanza.

La finitura *fumo (smoke)* esalta la precisione del vetro soffiato e conferisce un sottile fascino metropolitano. Questa tonalità scura si arricchisce di un prezioso trattamento *lucido (glossy)*, e diventa un accento decorativo raffinato e discreto.

Products

- 1 Easy Peasy Flamingo
- 1 Easy Peasy Chestnut
- 1 JIM
- 2 Nostalgia
- 2 Random
- 2 Random Solo
- 2 Sky-Fall

White

Foundational
► 3/4

White has purity and creativity at its core. As opposite to black, it contains all the colours of the light spectrum. In home décor, it is a simple and balanced solution which opens up endless possibilities. Matte, frosted or shiny, coupled with any material, it is always a candid choice.

Il bianco ha al suo centro la purezza e la creatività. Al contrario del nero, contiene tutti i colori dello spettro luminoso. Nell'arredamento d'interni è una soluzione semplice ed equilibrata che apre infinite possibilità. Opaco, satinato o lucido, accoppiato a qualsiasi materiale, è sempre una scelta sincera.



1 White
Bianco

2 Polished White
Bianco Lucido

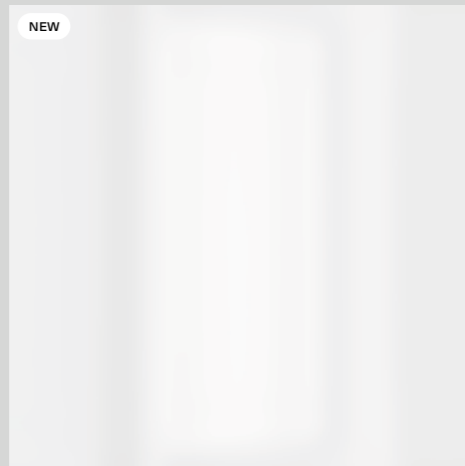

3 Frosted White
Bianco Satinato

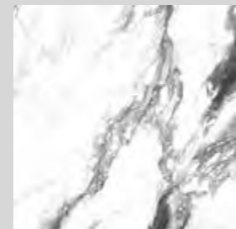

4 Renoir by Infinity™

5 Matte White – 9010
Bianco Opaco – 9010

6 Matte White – 9016
Bianco Opaco – 9016

Products

- 5 Aile
- 5 A-Tube
- 5 A-Tube Nano
- 5 A-Tube Nano Duo
- 5 Beetle
- 1, 5 Bugia
- 5 Frozen
- 5 JIM
- 5 Kelly
- 5 Kelly Cluster
- 5 Laser
- 3, 6 Make-Up
- 5 Nautilus
- 5 Nautilus Mini
- 5 Nautilus Spot
- 5 Pin-Up
- 6 Puzzle
- 4, 6 Puzzle Mega
- 6 Puzzle Outdoor
- 6 Puzzle Round
- 6 Puzzle Twist
- 3 Random
- 3 Random Solo
- 5 Spider
- 2 Valentina

Clear

Foundational
► 4/4

Transparency celebrates the forms, softens the rigour of geometries and releases the energy of light. Transparent materials give weightlessness to the lamps and let the light decorate and animate any interior living spaces.

La trasparenza esalta le forme, ammorbidisce il rigore delle geometrie e sprigiona l'energia della luce. I materiali trasparenti conferiscono leggerezza alle lampade e lasciano alla luce il compito di arredare e animare gli ambienti di vita.



1 Clear
Trasparente



2 Clear Crystal
Cristallo Trasparente

Products

- 1 A-Tube
- 1 A-Tube Nano
- 1 A-Tube Nano Duo
- 1 Blow
- 2 Jefferson
- 1 Nostalgia
- 1 Random
- 1 Random Solo
- 1 Sky-Fall
- 1 Valentina

Precious

Palladium

Silver

Gold

Palladium

Precious

► 1/3

A rare metal that adds a precious finish to the collection, a sophisticated accent with incredible inner strength. *Palladium*, a subtle premium touch.

Un metallo raro che aggiunge una finitura preziosa alla collezione, un accento sofisticato con una incredibile forza interiore. *Palladio (Palladium)*, un sottile tocco di qualità superiore.

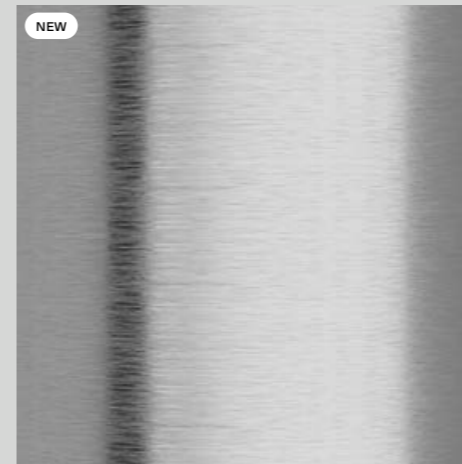

1 Brushed Palladium
Palladio Spazzolato

Silver

Precious
► 2/3

A touch as silvery as moonlight, the *chrome* finish embodies ductility. A vibrant, well-balanced colour, *chrome* perfectly accompanies the other shades of the Lodes colour palette and any contemporary interior design style.

Un tocco argenteo come il chiaro di luna, il *cromo* (*chrome*) interpreta la duttilità. Un colore vibrante ed equilibrato, il *cromo* accompagna perfettamente le altre tonalità della gamma di colori Lodes e qualsiasi stile di interior design contemporaneo.

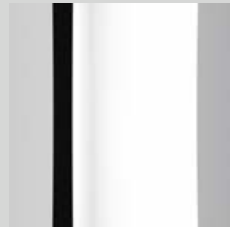

1 Chrome
Cromo

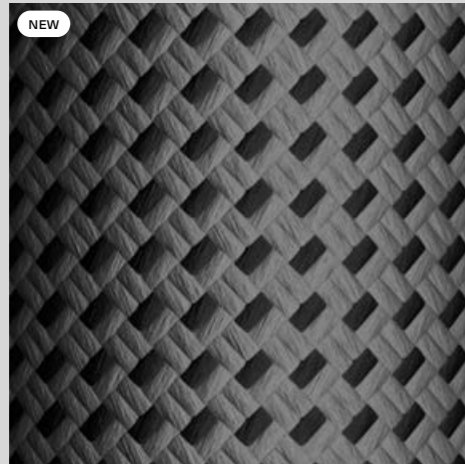

2 Silver
Argento

3 Polished Chrome
Cromo Lucido

4 Brushed Chrome ^{NEW}
Cromo Spazzolato

Products

- 1 A-Tube Nano
- 1 A-Tube Nano Duo
- 1 Blow
- 1 Bugia
- 2 Cima
- 1 Nautilus
- 1 Nautilus Spot
- 1 Nostalgia
- 1,4 Rain
- 1 Random
- 1 Random Solo
- 1 Sky-Fall
- 1,4 Spider
- 1,3 Valentina

Gold

Precious
► 3/3

Synonymous with elegance and value, *gold* represents timeless perfection, everlasting beauty. Shiny or brushed, the *gold* finish lends a graceful touch to the different shapes of our lamps.

Sinonimo di eleganza e valore, *l'oro* rappresenta la perfezione senza tempo, la bellezza immutabile. Lucido o spazzolato, *l'oro* (*gold*) conferisce un tocco aggraziato alle forme sempre diverse delle lampade Lodes.

In a pale yet characterful *champagne* tone, light matte gold stands for subdued refinement. A fine touch of magnetic attraction on metal surfaces.

In una tonalità *champagne* pallida ma di carattere, l'oro opaco chiaro è sinonimo di sobria raffinatezza. Un sottile tocco di attrazione magnetica sulle superfici metalliche.

Rose gold softens the classicism of pure gold with a coppery touch of passion and the brilliance of silver. Fresh and romantic, it stands for a personal choice, elegant and refined, which suits the most different styles of interior decoration.

L'oro rosa (*rose gold*) stempera il classicismo dell'oro con un tocco ramato di passione e la brillantezza dell'argento. Fresco e romantico, rappresenta una scelta personale, distinta e raffinata, che si accompagna ai più diversi stili di arredamento d'interni.



1 Gold
Oro

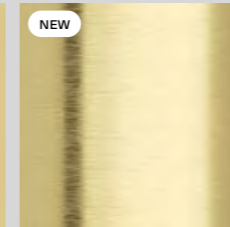

2 Brushed Gold
Oro Spazzolato



3 Matte Champagne
Champagne Opaco

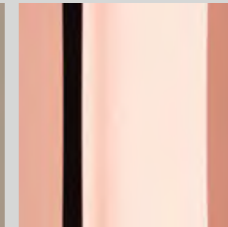

4 Rose Gold
Oro Rosa

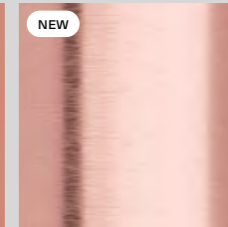

5 Brushed Rose Gold
Oro Rosa Spazzolato

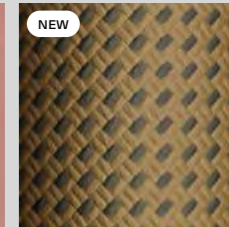

6 Gold
Oro

Products

- 3 Aile
- 1, 3, 4 A-Tube Nano
- 1, 3, 4 A-Tube Nano Duo
- 1 Bugia
- 6 Cima
- 5 Easy Peasy Kelp
- 2 Easy Peasy Lagoon
- 3 JIM
- 1 Jefferson
- 3 Kelly Cluster
- 3 Kelly dome
- 3 Nautilus
- 3 Nautilus Mini
- 3 Nautilus Spot
- 1,4 Nostalgia
- 1,4 Rain
- 1,4 Random
- 1,4 Random Solo
- 4 Sky-Fall
- 1, 3, 4 Spider
- 1,4 Valentina

Warm

Bronze

Honey

Bronze

Warm
► 1/2

Light turns the hardness of *bronze* into a sophisticated tone with warm accents. This earthy colour inspires stability and sturdiness and infuses calmness to any living environments.

As brilliant as the creative touch it bestows on the environment, *glossy bronze* is synonymous with alluring beauty.

La luce trasforma la durezza del *bronzo* (*bronze*) in un tono sofisticato con accenti caldi. Questo colore terroso ispira stabilità e robustezza e infonde calma a qualsiasi ambiente abitativo.

Brillante come il tocco creativo che infonde all'ambiente, il *bronzo lucido* (*glossy bronze*) è sinonimo di bellezza affascinante.



1 Coppery Bronze
Bronzo Ramato

2 Glossy Bronze
Bronzo Lucido

3 Brushed Bronze
Bronzo Spazzolato

Products

- 1 A-Tube
- 2 Bugia
- 3 Easy Peasy Flamingo
- 1 Frozen
- 1 JIM
- 1 Kelly
- 1 Kelly Cluster
- 1 Laser
- 2 Nostalgia
- 1 Pin-Up
- 1 Puzzle Round
- 1 Rain
- 2 Sky-Fall

Honey

Warm
► 2/2

The *honey* finish conveys the richness and warmth reminiscent of the precious nectar. On our lamps, translucent glass and polymers convey the energy of this age-old nutrient.

La finitura *miele* (*honey*) trasmette ricchezza e calore che ricordano il prezioso nettare. Nelle nostre lampade, il vetro traslucido e i polimeri trasmettono l'energia di questo antichissimo alimento.

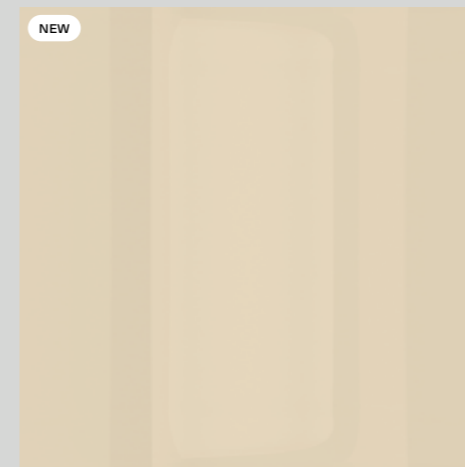

1 Honey
Miele

Products

- Easy Peasy Kelp
- Easy Peasy Lagoon
- JIM

Trend

Green

Yellow

Red

Green

Yellow

Red

The symbol of everlasting natural energy, the dark *green* colour is at once ambitious and sophisticated. A solid personality which gives a velvety perspective to the interior environments that welcome it.

A touch of self-confidence and optimism! *Yellow* brings a touch of sunshine into the home, sparking creativity and positive energy.

Love and anger, bravery and lust, *red* is the colour of extremes. At Lodes, it's the passion stemming from our Italian roots.

Simbolo dell'eterna energia naturale, il colore *verde (green)* scuro è al tempo stesso ambizioso e sofisticato. Una personalità solida che dona una prospettiva vellutata agli ambienti interni che la accolgono.

Un tocco di autostima e di ottimismo! Il *giallo* porta un raggio di sole negli spazi abitativi, sprigionando creatività ed energia positiva.

Amore e rabbia, coraggio e lussuria, il *rosso* è il colore degli estremi. In Lodes, è la passione che nasce dalle nostre radici italiane.

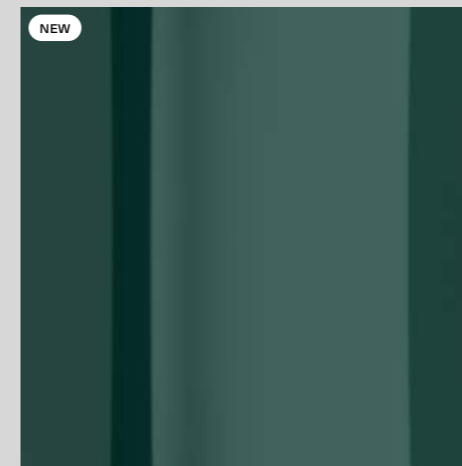

1 Green
Verde

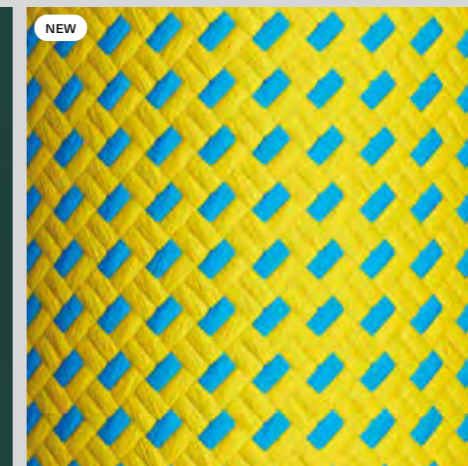

2 Yellow
Giallo

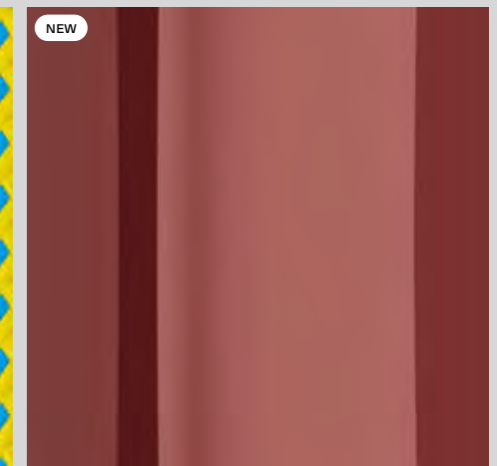

3 Lacquer Red
Rosso Lacca

Products

- 3 Aile
- 2 Cima
- 1 Easy Peasy Kelp

Pastels, Revisited

Turquoise

Taupe

Pink

Turquoise

Taupe

Pink

Turquoise is a brilliant accent that graces Lodes lamps, a precious ornamental touch like a fine gemstone.

Taupe is a classic organic hue, absolutely versatile for any style and personality.

Pink is glossy irreverence, with a touch of fresh salmon, bold candy and playful energy.

Il *turchese (turquoise)* è un accento brillante che abbellisce le lampade Lodes, un tocco ornamentale pregiato come una pietra preziosa.

Il *taupe* è una classica tonalità organica, assolutamente versatile per qualsiasi stile e personalità.

Il *rosa (pink)* è irriverenza scintillante, con un tocco di salmone fresco, di caramelle gommosi e di energia giocosa.

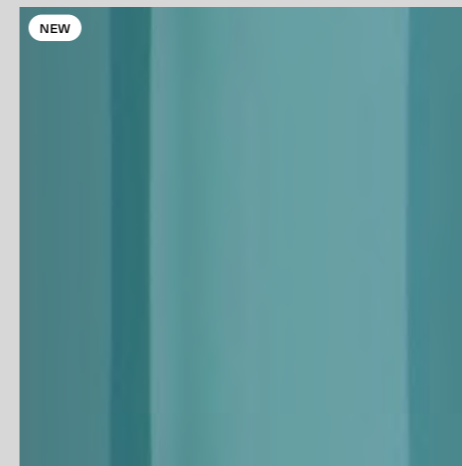

1 Turquoise
Turchese

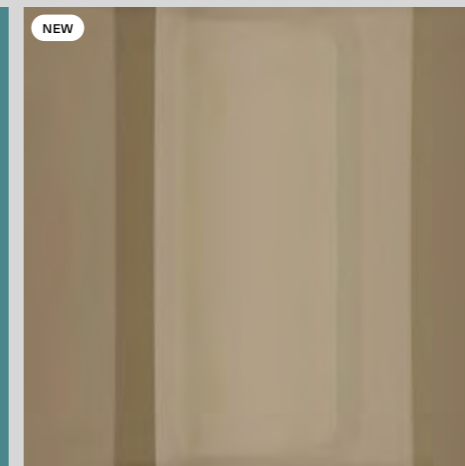

2 Taupe
Grigio Caldo

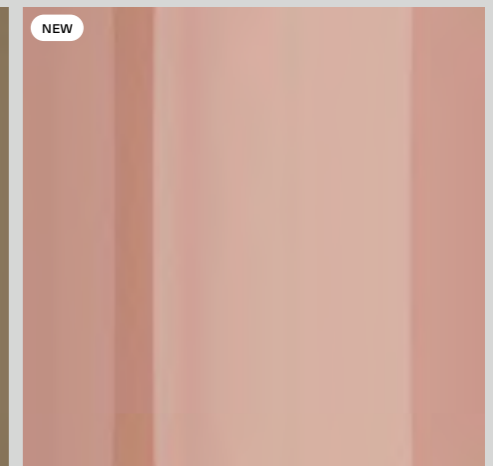

3 Pink
Rosa

Products

- 3 Easy Peasy Flamingo
- 1 Easy Peasy Lagoon
- 2 Easy Peasy Chestnut
- 1 JIM

Pag.	Spec sheet	Product name	Category	Year
134	143	A-Tube mini	Ceiling lamp	2013
		small	Cluster suspension lamp, Ceiling lamp	2013
		medium	Cluster suspension lamp, Ceiling lamp	2013
		large	Cluster suspension lamp, Ceiling lamp	2013
108	120	A-Tube Nano small	Cluster suspension lamp	2016
		medium	Cluster suspension lamp	2016
		large	Cluster suspension lamp	2016
124	133	A-Tube Nano Duo	Cluster suspension lamp	2017
268	277	Aile	Wall lamp	2021
336	339	Beetle	mini cube	Wall lamp, Ceiling lamp
158	161	Blow	Table lamp	2005
098	106	Bugia	Single	Ceiling lamp
		Double	Ceiling lamp	2016
		Triple	Ceiling lamp	2016
		Mega	Ceiling lamp	2020
146	157	Cima	Suspension lamp, Floor lamp	2021
018	029	Easy Peasy	Flamingo	Cordless table lamp
		Lagoon	Cordless table lamp	2020
		Kelp	Cordless table lamp	2020
		Chestnut	Cordless table lamp	2020
346	351	Frozen	small	Ceiling lamp
		medium	Ceiling lamp	2015
		large	Ceiling lamp	2015
208	219	Jefferson	mini	Cluster suspension lamp
		small	Cluster suspension lamp	2019
		medium	Cluster suspension lamp	2019
220	234	JIM	cylinder	Cluster suspension lamp
		cone	Cluster suspension lamp	2021
		bell	Cluster suspension lamp	2021
		dome	Suspension lamp	2021
248	261	Kelly	small dome 50	Suspension lamp
		medium dome 60	Suspension lamp	2015
		large dome 80	Suspension lamp	2015
		small sphere 40	Suspension lamp	2015
		medium sphere 50	Suspension lamp	2015
		large sphere 80	Suspension lamp	2015
		wall	Wall lamp	2015
238	247	Kelly Cluster	Cluster suspension lamp	2015
264	267	Laser	10 x 6	Wall lamp
		10 x 10	Wall lamp	2004/2015
340	345	Make-Up	small	Wall lamp, Ceiling lamp
		medium	Wall lamp, Ceiling lamp	2015
		large	Wall lamp, Ceiling lamp	2015
042	059	Nautilus	Suspension lamp	2019
		Spot	Ceiling lamp	2017
		Mini	Wall lamp	2017
192	206	Nostalgia	small	Cluster suspension lamp
		medium	Cluster suspension lamp	2015
		large	Cluster suspension lamp	2015
090	097	Pin-Up	Wall lamp, Ceiling lamp	2015
294	303	Puzzle	single square	Wall lamp, Ceiling lamp
		double square	Wall lamp, Ceiling lamp	2014
		square & rectangle	Wall lamp, Ceiling lamp	2014
		double rectangle	Wall lamp, Ceiling lamp	2014
294	305	Puzzle Twist	Wall lamp, Ceiling lamp	2014
278	288	Puzzle Mega	round small	Wall lamp, Ceiling lamp
		round large	Wall lamp, Ceiling lamp	2019
		square small	Wall lamp, Ceiling lamp	2019
		square large	Wall lamp, Ceiling lamp	2019
		rectangular	Wall lamp, Ceiling lamp	2019
316	322	Puzzle Outdoor	single square	Wall lamp, Ceiling lamp
		double square	Wall lamp, Ceiling lamp	2019
		double & rectangle	Wall lamp, Ceiling lamp	2019
		double rectangle	Wall lamp, Ceiling lamp	2019
		round single	Wall lamp, Ceiling lamp	2019
		round double	Wall lamp, Ceiling lamp	2019
306	315	Puzzle Round	single	Wall lamp, Ceiling lamp
		double	Wall lamp, Ceiling lamp	2016
062	074	Rain	Cluster suspension lamp	2015
178	191	Random	Cluster suspension lamp	2017
162	175	Random Solo	12	Cluster suspension lamp
		14	Cluster suspension lamp	2020
		18	Cluster suspension lamp	2020
		23	Cluster suspension lamp	2020
		28	Cluster suspension lamp	2020
030	040	Sky-Fall	medium	Suspension lamp
		large	Suspension lamp	2014
076	089	Spider	Cluster suspension lamp	2015
324	334	Valentina	Cordless table lamp	2018
			Table lamp	2018
			Cluster suspension lamp	2018
			Wall lamp	2018

Art. 1 Recital
Unless otherwise provided for in a separate written agreement between the parties, every sale of products of Lodes S.r.l., VAT 02992370276 (hereinafter, "the Seller") is governed by the following General Conditions of Sale that must be considered as an essential part of this agreement and shall be deemed to have been accepted by the Buyer even though the latter has not signed them. Any clause unilaterally added by the Buyer in the documentation signed by it and / or in its correspondence, being against or in any case in addition to the general conditions or to those specific expressly approved in writing by the Seller, shall be deemed as not written and shall be of no effect.

Art. 2 Completion of the sale, quantities and prices

The sale is deemed to be completed once the Seller gives the written order confirmation also by fax and / or email or when deliveries are commenced in cases where the immediate delivery of the supply is requested, also in consideration of changes occurred and then accepted by the customer. The prices agreed are understood for products delivered ex works of the Seller and do not include services and accessory charges (such as VAT, special packaging, transport and installation costs, and/or assemblages and so on).

Art. 3 Delivery, risk transfer and transport

Products are delivered to the Buyer at the Seller's plant or at another place indicated in writing by the Seller, and the risk transfer takes place with the delivery of the goods to the first carrier or Buyer in the events of collection of goods directly carried out by the latter. The products always travel at the Buyer's sole risk also when the carrier is selected and appointed by the Seller, being the latter freed from all responsibilities after having delivered the products to the carrier, this delivery is deemed to all effects being carried out directly by the said Buyer. The delivery terms agreed are to be understood as indicative. If the Seller is responsible for delay of delivery for a period of up to 60 days, the Buyer is not entitled either to refuse the supply or to request the termination of the agreement and / or the compensation for any damages. If the delay in delivery exceeds 60 days, the Buyer is entitled to request – by registered letter – the cancellation of the order and the reimbursement of the advances if paid. In any event, the Seller shall not be liable for and / or direct and indirect damages of any nature and for any reason due to the delay or the failure to carry out the supply.

Art. 4 Reservation of title

The Buyer acquires property rights over the goods with the full payment of the price invoiced of the supplies but it takes the risks thereof as of the delivery.

Art. 5 Products features and conditions of use

Unless otherwise expressly agreed in writing by the parties, the conditions for using of the products are those communicated or in any case resulting from the drawings and technical specifications of the Seller, if any, or as described in the website www.lodes.com in relation to products. The quality levels of products are the standard quality levels of the Sellers, indicated in the relevant specifications as described on the Seller's website. It is always the Buyer's responsibility to identify and notify the Seller of the conditions of use of products before technically defining them. Failing any particular instructions from the Buyer, the Seller considers as usual conditions of use those it considered or described in its designs and technical documentation.

Art. 6 Warranties

The products delivered are covered by a warranty for defects in material and manufacture for a period of 24 months as of the delivery if the Buyer is a natural person, otherwise the warranty period will be of 12 months as of the delivery. The Seller shall replace

the products delivered in this warranty period being faulty due to factory defects or in alternative, at its discretion, pay the Buyer an amount equal to the price already invoiced of the said products, being expressly excluded and waived any other right or claim by the Buyer also as compensation for direct and / or indirect damages or cost repayment borne by it (such as recovery, technical assistance, recalling costs, etc.). The Seller will anticipate the delivery of the replaced product, invoicing it regularly. Successively, when the product arrive to the Seller's warehouse, the latter will credit the amount of the defective product. The transport's costs will be paid by the Seller. Should the defected item be returned in an inadequate non-original packaging, with damages connected to the transport, The Seller will not credit any amount to the Buyer, and it will return the product to the sender at his own expenses. If the replacement was made for alleged defects in material and manufacture, but after the control carried out by the Seller, it is considered

(i) unfounded, due to the absence of defects; (ii) further damaged by insufficient packaging in the return transport (iii) spoiled by tampering made by the Buyer, all transportation costs and the entire value of the product will be charged to the latter. Any defectiveness or non-compliance of products shall be reported by the Buyer by writing to the Seller – in order to be valid – within 8 days from receipt of goods; any hidden defects shall be reported by the Buyer by writing to the Seller – always in order to be valid – within 8 days as of the relevant discovery. It being understood that the Seller will not be responsible for any defect even though hidden, being notified in writing, after 24 months of the delivery of goods. The warranty does not apply where the defects identified are due to the Buyer's negligence and / or to the use of products being not compliant with the information and explanations in any case gave by the Seller, technical provisions, to incorrect design, application, assembly or manufacture of the facilities in which they are installed, to incorrect maintenance carried out by unauthorized personnel, to improper cleaning since it is made with materials and manners being not suitable, to incorrect storage, handling and transport, to improper or imprudent use, also in the event of electrical system and its capacity being not suitable, or to circumstances that in any case cannot be related to the production defectiveness by the Seller. Every single product of the Seller corresponds to the mark laid down by the European Community with Directive 93 / 68 (extension of Directive 73 / 23) to confirm, with a mark recognized all over Europe, that the lights have undergone the electrical safety test required by European standards EN-60598-1-2 II ed. + CEI EN 60598-1 IV ed. corresponding to Italian standards CEI 34-21 + CEI 34-23, electrical safety standards referred to by all institutions, including the IMQ. The products indicated with the logo UL and / or ETL corresponds to the standards UL 1598 / CAN / USA C22.2 No.250.0 o UL 153.

Art. 7 Buyer's Obligations

The Buyer is required to immediately take delivery of the goods given by the Seller to the carrier, or – where otherwise agreed – to timely collect them at the Seller's plant on the date on which the Seller communicates, by any means, that the goods are ready. Where the Buyer delays the collection of the production for a period exceeding 10 days, in addition to the payment of price it shall pay the Seller a proper compensation equal to 2% per day of the price invoiced for storing such products. The Buyer shall carry out the payments normally, in accordance with the terms and conditions specified in the invoice. For late payments it will be accrued by default without need of further notification interest under Legislative Decree no. 231 / 2002. In the event of payment delays, the Seller is entitled to immediately suspend any supply, even though it has concluded other agreements with the same Buyer. The failure to pay within the terms agreed will cause in any event the loss of favourable terms for the Buyer.

Art. 8 Replacement of the Product

If a product is returned for commercial reasons or for a mistake in the order made by the Buyer, the Seller will retain an amount equal to the 20% of the total price as cost for reconditioning the product. If the returned product had already been used and / or it has been returned in an inadequate original packaging, with consequent transport damages, the Seller will not credit to the Buyer any amount and it will return the product to the sender at his own expenses. Only the articles in the catalogue and in the price list in force at the time of the request will be taken into consideration. Transport's costs are always charged to the Buyer. The repair of damaged products will be authorized only if the damage has been caused by the Buyer. The Buyer, once accepted repair costs, will take care of returning the damaged product to the Seller's warehouse and it will pay the costs of transporting the repaired product.

Art. 9 Force majeure

If the Seller is unable to comply with the agreement due to force majeure or beyond its control events, the deadlines set for the supply are automatically extended for a period in which these effects continue. Where the obstacle to comply with the agreement is longer than 6 months, both parties may request the termination of the agreement and, in such event, the Seller repay the Buyer the advances received, if any, releasing itself from any additional obligation on it.

Art. 10 Agreement

In the event of execution of a specific agreement signed by the parties, the said agreement together with its Annexes provides for and summarizes the obligations validly undertaken by the parties and being binding for them. The fulfilment by the parties will be subject to effective evaluation of the actual performance of the contractual tasks and duties to be carried out in good faith, with honesty and fairness. These General Conditions of Sale shall apply to the agreement, unless otherwise provided in writing by the parties or expressly provided in the said agreement.

Art. 11 Privacy Policy

The Seller will use the data received from the Buyer in accordance with the provisions of the article 13 of EU Regulation 2016 / 679 of 27 April 2016 (GDPR). For more information are available at the following link: www.lodes.com/legal-section/.

Art. 12 Disputes

Any dispute which may arise concerning the signing, validity, interpretation, performance, amendment and termination of the agreement or of these General Conditions of Sale will be settled according to principles and rule set forth in Article 13 below.

Art. 13 Jurisdiction and Applicable Law

The Court of Milan, Italy, shall be held exclusively competent, being any other court of competent jurisdiction expressly excluded, and the Italian Law shall be applicable.

Art. 14 Website

These General Conditions of Sale are those indicated on the website www.lodes.com and may be printed and reproduced on paper. The Seller undertakes to update the website www.lodes.com by publishing on it the version of the General Conditions of Sale as amended from time to time.

Art. 1 Premessa

Salvo deroga risultante da apposito accordo scritto tra le parti, ogni compravendita di prodotti di Lodes S.r.l., PIVA 02992370276 (di seguito: "Venditore") è regolata dalle seguenti Condizioni Generali di Vendita che costituiscono parte essenziale del contratto e che si intendono pertanto accettate dal Compratore ancorché dallo stesso non sottoscritte. Qualsiasi clausola unilateralmente apposta dal Compratore nei documenti da lui sottoscritti e / o nella sua corrispondenza, che sia contraria o comunque in aggiunta alle seguenti condizioni generali od a quelle speciali espressamente approvate per iscritto dal Venditore, si intende come non scritta ed è priva di ogni effetto.

Art. 2 Perfezionamento della compravendita, quantitativi e prezzi

La compravendita si intende perfezionata con la conferma d'ordine scritta del Venditore anche a mezzo fax e / o posta elettronica o con l'inizio delle consegne per i casi in cui è stata richiesta l'immediata consegna della fornitura anche in presenza di modifiche intervenute e quindi accettate dal cliente. I prezzi concordati si intendono per prodotti consegnati franco stabilimento del Venditore e non comprendono prestazioni ed oneri accessori (quali IVA, imballo speciale, spese di trasporto, di installazione e / o montaggi e così via).

Art. 3 Consegna, trasferimento del rischio e trasporto

La merce viene consegnata al Compratore presso lo stabilimento del Venditore o in altro sito dallo stesso indicato per iscritto, ed il trasferimento del rischio avviene con la consegna della stessa al primo vettore o al Compratore nelle ipotesi di ritiro della merce da quest'ultimo direttamente eseguita. La merce viaggia sempre a rischio esclusivo del Compratore anche quando il vettore dovesse essere scelto ed incaricato dal Venditore, essendo quest'ultimo liberato da ogni responsabilità con la consegna dei prodotti al vettore, che ad ogni effetto si intende eseguita a mani dallo stesso Compratore. I termini di consegna pattuiti si intendono indicativi. In caso di ritardo nella consegna imputabile al Venditore per un periodo fino a 60 gg il Compratore non ha il diritto di rifiutare la fornitura, né di richiedere la risoluzione del contratto e / o il risarcimento di alcun danno. Se il ritardo nella consegna supera il termine di 60 gg il Compratore ha la facoltà di richiedere – con lettera raccomandata – l'annullamento dell'ordine e la restituzione degli anticipi eventualmente versati. Resta in ogni caso escluso qualsivoglia obbligo del Venditore di risarcimento danni diretti e / o indiretti di qualsiasi natura e per qualsiasi ragione, in dipendenza del ritardo ovvero della mancata esecuzione della fornitura.

Art. 4 Riserva di proprietà

Il Compratore acquista la proprietà della merce solo con il pagamento integrale del prezzo fatturato delle forniture ma ne assume i rischi dal momento della consegna.

Art. 5 Caratteristiche dei prodotti e condizioni di utilizzo

Salvo diverso ed espresso accordo scritto tra le parti, i parametri funzionali dei prodotti sono quelli espressi comunicati o comunque risultanti nei disegni e specifiche tecniche del Venditore se esistenti o su quanto indicato sul sito web www.lodes.com relativamente ai prodotti. I livelli di qualità dei prodotti forniti sono quelli standard del Venditore, evidenziati nelle relative specifiche o su quanto indicato e desumibile sul sito web del Venditore. È onere del Compratore individuare e comunicare al Venditore le condizioni di utilizzo dei prodotti prima della relativa definizione tecnica. In mancanza di indicazioni da parte del Compratore il Venditore considera condizioni di utilizzo quelle di prassi dallo stesso considerate o esplicitate nei propri disegni e documentazione tecnica.

Art. 6 Garanzie

I prodotti forniti sono coperti da garanzia per difetti di materiale e / o fabbricazione per un periodo di 24 mesi dalla consegna se il Compratore risulta essere una persona fisica, diversamente il periodo di garanzia sarà di 12 mesi dalla consegna. Il Venditore sostituisce i prodotti resi in detto periodo di garanzia e riconosciuti difettosi per vizi d'origine ovvero in alternativa ed a sua scelta accreditata al Compratore una somma pari al prezzo già fatturato dei prodotti stessi, restando espressamente escluso e rinunciato qualsiasi diverso diritto o pretesa del Compratore anche a titolo di risarcimento danni diretti e / o indiretti o di rimborso di costi dallo stesso sostenuti (quali costo di riprese, di assistenza tecnica, di richiamo, ecc.). Il Venditore anticiperà l'invio del prodotto in sostituzione, fatturandolo regolarmente, andando poi ad accreditare l'importo alla riconsegna del prodotto difettoso reso. Le spese di trasporto saranno a carico del Venditore. Qualora l'articolo oggetto del reso venisse riconsegnato in un imballo non originale inadeguato con conseguenti danni da trasporto, il Venditore non accrediterà al Compratore alcun importo e rinverrà al mittente, a sue spese il prodotto. Qualora il reso venisse effettuato per presunti vizi d'origine ma dopo il controllo effettuato dal Venditore lo stesso venisse ritenuto (i) infondato, per assenza di vizi; (ii) ulteriormente danneggiato da insufficiente imballaggio nel trasporto di ritorno (iii) viziato da manomissione posta in essere dal Compratore, verranno addebitati a quest'ultimo tutti i costi di trasporto nonché l'intero valore del prodotto. Eventuali difettosità o non conformità dei prodotti devono essere segnalate dal Compratore per iscritto al Venditore – a pena di decadenza – entro e non oltre 8 gg dalla data di ricevimento della merce; eventuali difetti occulti devono essere segnalati dal Compratore per iscritto al Venditore – sempre a pena di decadenza – entro 8 gg dalla relativa scoperta. Resta inteso che il Venditore non sarà responsabile per alcun vizio ancorché occulto, comunicato per iscritto, oltre 24 mesi dalla consegna della merce. La garanzia non opera ove i difetti rilevati siano imputabili a negligenza del Compratore e / o ad impiego dei prodotti non conforme con le informazioni e le spiegazioni in ogni caso fornite dal Venditore, alle prescrizioni tecniche, ad errata progettazione, applicazione, montaggio o fabbricazione delle strutture ove sono installati, ad errata manutenzione operata da personale non autorizzato, a pulizia impropria in quanto effettuata con modalità o materiali non idonei, ad errato magazzinaggio, movimentazione e trasporto, ad uso improprio od incauto, anche in caso di impianto elettrico e portata dello stesso non idonea, ovvero a circostanze che comunque non possono ricollegarsi a difettosità di produzione da parte del Venditore. Ogni singolo prodotto del Venditore è conforme alla marcatura richiesta dalla Comunità Europea con la direttiva 93 / 68 (ampliamento della direttiva 73 / 23) per confermare con una marcatura riconosciuta in tutta Europa, che le lampade sono state sottoposte alle prove di sicurezza elettrica richieste dalle norme Europee EN-60598-1-2 II ed. + CEI EN 60598-1 IV ed. corrispondenti norme italiane CEI 34-21 + CEI 34-23, norme per la sicurezza elettrica a cui fanno riferimento tutti gli istituti, compreso l'IMQ. I prodotti indicati con il marchio UL e / o ETL sono conformi alla normativa UL 1598 / CAN / USA C22.2 No.250.0 o UL 153.

Art. 7 Obblighi del Compratore

Il Compratore è tenuto a prendere immediatamente in consegna i prodotti affidati dal Venditore al vettore, ovvero – se diversamente concordato – a puntualmente ritirarli presso lo stabilimento del Venditore alla data di comunicazione di merce pronta che potrà avvenire con ogni mezzo da parte del Venditore. Ove il Compratore ritardi il ritiro dei prodotti per un periodo superiore a 10 gg, oltre al pagamento del prezzo deve corrispondere al Venditore un adeguato compenso pari al 2% al giorno dell'importo fatturato per il magazzinaggio degli stessi. Il Compratore deve effettuare i pagamenti normalmente, con le modalità e nei termini precisati in fattura. Sui ritardati pagamenti decorreranno, di pieno diritto e senza necessità di costituzione in mora, gli

interessi di cui al D.lgs. n. 231 / 2002. In caso di ritardo dei pagamenti il Venditore ha diritto a sospendere immediatamente ogni fornitura, anche se dipendente da altri contratti con lo stesso Compratore. Il mancato pagamento nei termini pattuiti comporta in ogni caso la decadenza del Compratore dal beneficio del termine.

Art. 8 Resi

In caso di reso commerciale o in caso di reso per errore del Compratore, il Venditore tratterà un importo pari al 20% minimo del totale a titolo di costo di ricondizionamento dell'articolo. Qualora l'articolo oggetto del reso fosse già stato utilizzato e / o venisse riconsegnato in un imballo non originale inadeguato, con conseguenti danni da trasporto, il Venditore non accrediterà al Compratore nessun importo e rinverrà al mittente, a sue spese, il reso. Verranno presi in considerazione solamente gli articoli presenti nel catalogo e nel listino in vigore al momento della richiesta. Le spese di trasporto sono sempre a carico del Compratore. I resi per riparazione vanno autorizzati solo se la causa del danno è dipesa dal Compratore che dopo aver accettato il costo di riparazione si occuperà a proprie spese di rispedire l'articolo danneggiato in sede e si accollerà poi i costi relativi al trasporto del prodotto riparato.

Art. 9 Forza maggiore

Qualora il Venditore sia impossibilitato a rispettare il contratto per cause di forza maggiore o comunque indipendenti dalla sua volontà, i termini previsti per l'esecuzione della fornitura sono automaticamente prorogati per un periodo equivalente al perdurare degli effetti di tali cause. Qualora la causa impeditiva continui per più di 6 mesi entrambe le parti possono chiedere la risoluzione del contratto ed in tal caso il Venditore restituisce al Compratore gli anticipi eventualmente ricevuti, con esclusione di ogni e qualsiasi onere ulteriore a suo carico.

Art. 10 Contratto

In caso di sottoscrizione di apposito contratto lo stesso con i suoi allegati contiene e riassume le obbligazioni validamente assunte dalle parti e per esse vincolanti. L'adempimento delle parti sarà oggetto di valutazione dell'effettiva esecuzione dei compiti e doveri contrattuali, da effettuarsi in buona fede, onestà e con equità. Le presenti Condizioni Generali di Vendita si applicheranno al contratto salvo deroga risultante da atto scritto o in esso contratto esplicitamente prevista.

Art. 11 Trattamento dei Dati Personali

Il Venditore utilizzerà i dati ricevuti dal Compratore conformemente alle disposizioni vigenti in materia di Privacy secondo l'art. 13 del Regolamento Europeo 2016 / 679 (GDPR). Maggiori informazioni sono disponibili al seguente link: www.lodes.com/area-legale/.

Art. 12 Controversie

Qualora dovesse verificarsi una qualsivoglia controversia avente ad oggetto la formazione, validità, interpretazione, esecuzione, modifica e risoluzione del contratto o delle presenti Condizioni Generali di Vendita, questa sarà risolta secondo i principi e le regole indicate nell'articolo 13 che segue.

Art. 13 Foro competente e legge applicabile

Foro esclusivamente competente sarà quello di Milano con esplicita esclusione di ogni altro foro alternativamente competente, e la legge applicabile quella italiana.

Art. 14 Sito Web

Le presenti Condizioni Generali di Vendita, sono quelle risultanti sul sito web www.lodes.com e sono stampabili e riproducibili su supporto cartaceo. Il Venditore si impegna ad aggiornare il sito web www.lodes.com mediante la pubblicazione sullo stesso della versione di Condizioni Generali di Vendita di volta in volta modificata.

Head office

Lodes, via Pialoi 32,
30020 Marcon (Venezia) Italy
T +39 041 45 69 266

General information
info@lodes.com

Lodes 2021
Collection Catalogue

*Art direction
and graphic design*
Think Work Observe

Images
Bruger Studio

Photography
Mattia Balsamini
(pag. 002–008)
Studio Pointer

Copywritings
Lodes

*Colour separation
and printing*
Nava

Showrooms

Flagship Store – Paris
Novaluce S.a.r.l.
131 Rue du Faubourg
Saint-Honoré
75008 Parigi, Francia
T. +33 142 890 318
paris@lodes.com

Flagship Store – Doha
Abensal Lighting
C-Ring Road, St. 230
Zone 41, Building no. 245
Al Hilal – Doha, Qatar
T. +974 4016 4866
qatar@abensal.com

